



MicroSurvey FieldGenius 9 (2018-03-22)
Copyright © 2018 MicroSurvey Software Inc.
All Rights Reserved

MICROSURVEY END-USER LICENSE AGREEMENT

This MicroSurvey End-User License Agreement ("Agreement") is a legal and binding agreement between you ("Licensee") and MicroSurvey Software Inc., a BC corporation ("MICROSURVEY") concerning the use of the MicroSurvey products (the "Product"), the software provided in connection with the use and operation of the Product, including firmware and stored measurement data (collectively the "Software") and all related documentation provided in connection with the acquisition of the Product ("Documentation"). The Software includes software owned by, and licensed from, third party licensors.

By clicking the "**I ACCEPT**" check box and completing the process of installing the Software, LICENSEE consents to and agrees to be bound by all of the terms and conditions of this Agreement. BY CLICKING THE "I REJECT" CHECK BOX or IF LICENSEE disagrees with any of the terms or conditions of this Agreement, LICENSEE IS not permitted to install and/or use the Software, PRODUCT AND DOCUMENTATION. IF LICENSEE HAS ANY questions OR COMMENTS CONCERNING THIS AGREEMENT LICENSEE MAY CONTACT MICROSURVEY AT Westbank, BC Canada.

1. **Title to Product and Rights to Use Software and Documentation.** Title to the Product and the rights to use the Software and Documentation are conditioned upon the payment of the required purchase price and any applicable license and maintenance fees and Licensee's acceptance of the terms and conditions of this Agreement.
2. **License.**
 1. **License Grant.** MICROSURVEY hereby grants Licensee a nonexclusive, non-transferable, non-sublicensable right to (i) install and use one copy of the Software and Documentation on the Product and one copy for use on no more than one personal computer simultaneously, and , (ii) to access the stored measurement data generated by the Software, for Licensee's own internal business purposes and in accordance with the terms and conditions of this Agreement. MICROSURVEY also hereby grants Licensee a nonexclusive, non-sublicensable right to reproduce the Documentation, solely as necessary for Licensee's internal use of the Product and Software.
 2. **Conditions and Restrictions.** The following conditions and restrictions apply to the use of the Product, Software and Documentation:

- i. Licensee shall not, and shall not attempt to, reverse engineer, decompile, disassemble or otherwise attempt to identify the source code of any object code portions of, distribute, modify, encrypt, or create derivative works of the Software, Documentation, and/or any stored measurement data in whole or in part, including, but not limited to, stored measurement data.
 - ii. Licensee shall not use the Software or Documentation for any purpose not expressly permitted by this Agreement.
 - iii. Licensee shall not copy any part of the Software, except that Licensee may make one copy of the Software for backup purposes only.
 - iv. Licensee agrees not to remove or destroy any copyright, logo, trademark, trade name, proprietary markings, or confidentiality legends placed upon or contained within the Software or Documentation. Licensee shall not, and agree not to assist others to, circumvent or disable the license provisioning technology for the Software.
 - v. Licensee's license to the Software under this Agreement continues until it is terminated by Licensee or MICROSURVEY. Licensee may terminate the license by discontinuing use of all or any of the Software and by destroying all Licensee copies of the Software and Documentation.
 - vi. This Agreement will terminate automatically if (x) Licensee violate any of the terms or conditions of this Agreement, (y) MICROSURVEY publicly posts a written notice of termination on its website www.microsurvey.com (that, or any successor site, the "Site"); or (z) MICROSURVEY revokes this Agreement or issues a new agreement in writing or electronic form and conditions Licensee continued use of the Software upon acceptance of the new agreement.
3. **Ownership.** All rights, title and interest in and to the Software and Documentation including, without limitation, all copyright, patent, trade secret and other intellectual property rights shall at all times remain the property of MICROSURVEY, its licensors, or its suppliers, as applicable. The Software and Documentation are licensed, not sold, and are protected by copyright and other intellectual property laws and treaties. Licensee shall take appropriate steps reasonably calculated to notify others of MICROSURVEY and its licensor's/suppliers' ownership of the Software and Documentation.
4. **Warranty.** MICROSURVEY warrants that the Product will, for 90 days after the Effective Date (the "Warranty Period"), substantially conform to the Documentation; provided, that Licensee must notify MICROSURVEY in writing of any breach of the foregoing warranty within the Warranty Period. For any breach of the foregoing warranty reported during the Warranty Period, MICROSURVEY will use reasonable efforts to promptly correct such defect

without further charge. If MICROSURVEY is unable to correct such defect, then MICROSURVEY will refund the license fees paid for the Product. This represents MICROSURVEY'S exclusive liability and Licensee's sole and exclusive remedy in the event of a breach of the foregoing warranty.

5. **Warranty Disclaimer.** EXCEPT AS DESCRIBED IN SECTION 4 (WARRANTY), MICROSURVEY HEREBY DISCLAIMS ALL WARRANTIES RELATING TO THE PRODUCT, SOFTWARE, AND DOCUMENTATION, INCLUDING WITHOUT LIMITATION THE IMPLIED WARRANTIES OF MERCHANTABILITY, NON-INFRINGEMENT AND FITNESS FOR A PARTICULAR PURPOSE. MICROSURVEY DOES NOT REPRESENT THAT THE OPERATION OF THE PRODUCT AND/OR SOFTWARE WILL BE UNINTERRUPTED OR ERROR-FREE. WITHOUT LIMITING THE GENERALITY OF THE FOREGOING, MICROSURVEY MAKES NO WARRANTY THAT: (A) OPERATION OF THE PRODUCT AND/OR SOFTWARE WILL BE UNINTERRUPTED OR ERROR-FREE, (B) THE PRODUCT AND/OR SOFTWARE WILL MEET LICENSEE SPECIFIC NEEDS, (C) SPECIFIC RESULTS WILL BE ACHIEVED WITH THE PRODUCT AND/OR SOFTWARE, OR (D) ALL ERRORS OR FAILURES WILL BE CORRECTED. IN NO EVENT SHALL MICROSURVEY'S, ITS LICENSORS', OR ITS SUPPLIERS' LIABILITY TO LICENSEE FOR THE PRODUCT AND/OR SOFTWARE, WHETHER BASED ON CONTRACT, TORT, WARRANTY, OR ANY OTHER LEGAL THEORY, EXCEED THE AMOUNT OF PURCHASE PRICE PAID FOR THE PRODUCT AND ANY RELATED LICENSE OR MAINTENANCE FEES PAID BY LICENSEE.
6. **Exclusion of Damages.** TO THE MAXIMUM EXTENT PERMITTED BY APPLICABLE LAW, IN NO EVENT SHALL MICROSURVEY, ITS LICENSORS, OR ITS SUPPLIERS BE LIABLE FOR ANY SPECIAL, INCIDENTAL, PUNITIVE, INDIRECT, OR CONSEQUENTIAL DAMAGES WHATSOEVER (INCLUDING, BUT NOT LIMITED TO, DAMAGES FOR LOSS OF PROFITS OR OTHER DATA OR INFORMATION, OR FOR BUSINESS INTERRUPTION) ARISING OUT OF OR IN ANY WAY RELATED TO THE USE OF OR INABILITY TO USE THE PRODUCT AND/OR SOFTWARE, EVEN IN THE EVENT OF THE FAULT, TORT (INCLUDING NEGLIGENCE), STRICT LIABILITY, BREACH OF CONTRACT OR BREACH OF WARRANTY OF MICROSURVEY, ITS LICENSORS OR ANY SUPPLIERS, AND EVEN IF MICROSURVEY OR ANY OF ITS LICENSORS OR SUPPLIERS HAVE BEEN ADVISED OF THE POSSIBILITY OF SUCH DAMAGES. BECAUSE SOME JURISDICTIONS DO NOT ALLOW THE EXCLUSION OR LIMITATION OF LIABILITY FOR CONSEQUENTIAL OR INCIDENTAL DAMAGES, THE ABOVE LIMITATION MAY NOT APPLY TO LICENSEE.
7. **Limitation of Liability.** NOTWITHSTANDING ANY DAMAGES THAT LICENSEE MIGHT INCUR FOR ANY REASON WHATSOEVER (INCLUDING, WITHOUT LIMITATION, ALL

DAMAGES REFERENCED ABOVE AND ALL DIRECT OR GENERAL DAMAGES), THE ENTIRE LIABILITY OF MICROSURVEY AND ANY OF ITS LICENSORS OR SUPPLIERS UNDER ANY PROVISION OF THIS AGREEMENT AND LICENSEE EXCLUSIVE REMEDY FOR ALL OF THE FOREGOING SHALL BE LIMITED TO THE AMOUNT ACTUALLY PAID BY LICENSEE FOR THE PRODUCT AND ANY RELATED LICENSE OR MAINTENANCE FEES PAID BY LICENSEE. THE FOREGOING LIMITATIONS, EXCLUSIONS AND DISCLAIMERS (INCLUDING SECTIONS 5 AND 6 ABOVE) SHALL APPLY TO THE MAXIMUM EXTENT PERMITTED BY APPLICABLE LAW, EVEN IF ANY REMEDY FAILS ITS ESSENTIAL PURPOSE. LICENSEE ACKNOWLEDGES THAT (A) THE PROVISION OF THE PRODUCT AND SOFTWARE IS CONDITIONAL UPON MICROSURVEY EXCLUDING AND/OR LIMITING ITS AND ITS LICENSORS' AND SUPPLIERS' LIABILITY TO LICENSEE IN ACCORDANCE WITH THIS AGREEMENT, AND (B) THE EXCLUSIONS AND LIMITATION CONTAINED IN THIS AGREEMENT ARE FAIR AND REASONABLE IN ALL THE CIRCUMSTANCES KNOWN AT THE DATE OF THIS AGREEMENT.

8. **Indemnification.** Licensee agrees to defend, indemnify and hold MICROSURVEY, its affiliates, distributors, licensors, and suppliers harmless from and against any and all losses, damages, costs or expenses (including reasonable attorney's fees) (a) suffered by Licensee related in any way to the Product, Software, or this Agreement and/or (b) related to any claim or demand made by any third party in connection with or arising out of (i) any breach by Licensee of any of the terms and conditions of this Agreement, (ii) Licensee use or misuse of the Product or Software, (iii) Licensee violation of applicable laws, and/or (iv) Licensee violation of the rights of any other person or entity. MICROSURVEY reserves the right, at its own expense, to assume the exclusive defense and control of (but not liability for) any matter otherwise subject to indemnification by Licensee. Licensee will be liable to MICROSURVEY for reasonable attorney's fees in any such case.
9. **Support.**
 - a. **General.** Except as set forth in Section 9(b) (Website Support) and 9(c) (Contract Support), MICROSURVEY shall have no obligation under this Agreement to maintain or support the Software. Licensee may contact MICROSURVEY to inquire about MICROSURVEY'S commercially available support and maintenance services provided pursuant to separate agreements. This Agreement shall not obligate either party to enter into any such separate agreement. Any updates or error corrections to the Software that may be provided to Licensee from time-to-time, if any, shall be deemed Software hereunder and shall be licensed to Licensee under the terms and conditions of this Agreement. If any such updates or error corrections are made available to Licensee, then Licensee shall promptly (a) implement such updates or error

corrections, (b) cease using the earlier versions without such updates or error corrections, and (c) make such updates or error corrections available to the users of the earlier versions. Licensee shall be solely responsible for procuring all hardware and third-party software necessary to operate the Software.

- b. Website Support. MICROSURVEY will use reasonable commercial efforts to host and maintain a web site (the "Support Site") for the Software during its commercial life (as reasonably determined by MICROSURVEY) that will include some or all of the following features:
- A "Frequently Asked Questions" section with answers to common questions about the Software.
 - A searchable "Helpdesk" section with general user instructions and information about the Software.
 - A link to allow end users of the Software to download any bug fixes, error corrections or other updates to the Software that MICROSURVEY may make available through the Site.
 - "Contact MICROSURVEY" electronic response capability. MICROSURVEY will use reasonable commercial efforts to respond within two (2) business days to a customer inquiry received via this system. Answers to such inquiries will be added to the FAQ's, as appropriate.
- c. Contract Support. Upon mutual agreement in writing between Licensee and MICROSURVEY, or between Licensee and one of MICROSURVEY'S authorized resellers, MICROSURVEY will provide contracted support services to Licensee as may be agreed upon and related to the Software.

10. **Term and Termination.**

- a. This Agreement is effective until terminated. Licensee may terminate this Agreement at any time, with or without cause, upon notice to MICROSURVEY. MICROSURVEY may terminate this Agreement for Licensee's breach of this Agreement.
- b. Upon termination of this Agreement, Licensee shall immediately cease all use of the Software and Documentation and return to MICROSURVEY all copies of thereof within five (5) days after such termination. Upon MICROSURVEY'S request, Licensee will certify in writing to MICROSURVEY that all such copies have been returned to MICROSURVEY. The following provisions of this Agreement shall survive termination or expiration of this Agreement: Sections 2(b) (Restrictions), 3 (Ownership), 5 (Warranty Disclaimer), 6 (Exclusion of Damages), 7 (Limitation of Liability), 10 (Term and Termination), and 11 (General).

11. **General.**

- a. **Assignment.** MICROSURVEY may assign this Agreement without notice to Licensee. Licensee shall not assign this Agreement or transfer any of the rights, duties, or obligations arising under this Agreement without the prior written consent of MICROSURVEY. This Agreement shall be binding upon, and inure to the benefit of, the permitted successors and assigns of the parties thereto.
- b. **Amendments; Modifications.** Notices of changes to this Agreement or other matters may be made to Licensee by displaying notices or links to notices to Licensee generally on the Site.
- c. **Governing Law; Forum; Attorney's Fees, Injunctive Relief.** The terms of this Agreement shall be construed and governed exclusively by the laws of the province of British Columbia, excluding the application of its conflict of law provisions and rules. Any dispute, controversy or claim between the parties arising out of or relating to this Agreement or a breach of this Agreement shall be settled pursuant to the terms of this Section 11(c) by arbitration before three neutral arbitrators (selected from a panel of persons having experience with and knowledge of the computer business), provided at least one of which arbitrators shall be an attorney, and administered by the Arbitrators Association of British Columbia in accordance with its Commercial Arbitration Rules in Kelowna, British Columbia. Any provisional or equitable remedy which would be available from a court of law shall be available from the arbitrators to the parties. Judgment upon the award of the arbitrators may be enforced in any court having jurisdiction thereof. The parties hereby consent to the non-exclusive jurisdiction of the courts of the Province of British Columbia for any action (i) to compel arbitration, (ii) to enforce the award of the arbitrators or (iii) prior to the appointment and confirmation of the arbitrators, for temporary, interim or provisional equitable remedies, and to service of process in any such action by registered mail, return receipt requested, or by any other means provided by law. The application of the United Nations Convention of Contracts for the International Sale of Goods is expressly excluded.
- d. **Severability.** The illegality, invalidity or unenforceability of one or more provisions of this Agreement shall not affect the legality, validity or enforceability of any other provision, and this Agreement shall be construed in all respects as if such illegal, invalid or unenforceable provision were deemed amended to achieve as near as possible the same economic effect as the original in a legal, valid and enforceable manner if possible.
- e. **Further Relationships.** Neither party is obligated by this Agreement to enter into any further business relationship after the termination or expiration of this Agreement.

- f. **Notices.** All notices under this Agreement shall be in writing, and shall be deemed given when personally delivered, when received if by nationally recognized courier, or three days after being sent by postage prepaid, certified or registered Canadian Mail, as applicable, to MICROSURVEY at MICROSURVEY's address as set forth herein or to Licensee at the address that Licensee provided upon entering into this Agreement, or such other address as a party last provided to the other by written notice.
- g. **Independent Contractor.** MICROSURVEY and Licensee are independent contractors. No partnership, joint venture, or other joint relationship is created by this Agreement.
- h. **Entire Agreement.** This Agreement represents the entire agreement between the parties relating to its subject matter and supersedes all prior representations, discussions, negotiations and agreements. All changes, modifications, additions or deletions shall be effective immediately upon notice thereof, which may be given by means including, but not limited to, posting on the Site, or by electronic or conventional mail, or by any other means by which Licensee may obtain notice thereof. Use of the Product and/or Software after such notice constitutes acceptance of such changes, modifications or additions. This Agreement may be amended at any time by mutual agreement of the parties.

TECHNICAL SUPPORT

MicroSurvey Software Technical Support is available to help you get the most out of your MicroSurvey program. The following information explains how to prepare for your call so that your inquiry can be answered promptly and accurately.

Please prepare yourself before you call for Technical Support

Take a few minutes before you place your call to check the printed documentation and the online help files to see if the answer is already at your disposal. Our Web site on the Internet can also save time. Please check it for assistance if you can. Please have the following information available if requested: Hardware model, version of the program, and your Technical Support Number.

Please make sure that you have all the steps you completed prior to your problem and can explain them to the technical support representative. We may ask that you forward a copy of your data to us if we cannot find the problem immediately.

MicroSurvey offers a 90-day complimentary support period to all of our registered users, starting the date of purchase. Introductory support is available weekdays between 8:00 am and 5:00 pm (Pacific Time) excluding holidays.

Yearly Support

For clients who have had their original 90-day complimentary support period expire and feel that they will need ongoing support over the next year, we have a Yearly Support Contact option available. This gives you the ability to contact us for technical support, as much as you require, and you pay a flat fee once a year. This option is not to be used in place of training but is to assist you on the occasions when you really need it. The charge for the Yearly Support Contract is to be billed and paid for prior to the support commencing. This rate is subject to change, call for current rates.

Electronic Support

MicroSurvey maintains and provides at no charge, our Internet Web site at the following address:

<http://helpdesk.microsurvey.com>

This web site has sections on frequently asked questions, Technical Notes, Technical Specifications, and as required, free updates and program fixes, along with a lot of other helpful information.

Training

MicroSurvey Software Inc. can provide training to you, in your office or in a classroom situation (where facilities and numbers allow. MicroSurvey has training staff that will travel to almost anywhere and provide you with the professional skills you require to operate your MicroSurvey program. Please feel free to call and ask for a quotation or inquire about potential classroom situations. Your local dealer may also be able to setup or arrange a training session for you. Contact our head office for more information about training.

MICROSURVEY CONTACT INFORMATION

Corporate Head Office

MicroSurvey Software Inc.
205 – 3500 Carrington Road
Westbank, BC V4T 3C1
Canada

Office Hours: 8:00 am to 5:00 pm (Pacific Time)

(Monday to Friday, except holidays)

Sales & Technical Support 1-800-668-3312

International Voice: +1 250 707 0000

Fax: (250) 707-0150

Internet

Website: <http://www.microsurvey.com/>

Support Helpdesk: <http://helpdesk.microsurvey.com/>

General Information E-Mail: info@microsurvey.com

TABLE OF CONTENTS

MicroSurvey End-User License Agreement	2
Technical Support	9
MicroSurvey Contact Information	11
Table of Contents	12
Getting Started	23
Introduction	23
Hardware Requirements	23
Installing FieldGenius	24
Starting FieldGenius	24
Registration & Demo Mode	24
Activation	25
Product Registration	26
Available Modules	26
Run Demo Mode	27
Retrieve Lost Key Codes (passwords)	27
Technical Support	27
Project Manager	27
Project Review	29
Quick Start: Open Existing Project	30
Quick Start: New Project	33
Common FieldGenius Buttons	40
FieldGenius Project Files	41
Automatic Save	42
Data Entry (Extended Edit Fields)	42
Keypad	43
Distance Entry & Recall	45
Distance Entry	45
Distance Recall	45
Unit Modifiers	45

Distance Entry Examples	46
Using Math Operations	48
Direction Entry & Recall	49
Direction Entry	49
Direction Recall	49
Unit Modifiers	49
Direction Entry Examples	50
Using Math Operations	53
Main Interface	54
Two Versions of the User Interface	54
Portrait Display	55
Landscape Display	56
Toolbars	56
Display Toolbar	56
Observation Toolbar	58
3D View Toolbar	59
Total Station Toolbar	61
Robotic Total Station Toolbar	62
GNSS Toolbar	64
Disto/Laser Toolbar	66
Topo Toolbar	67
Mini Toolbar	70
Map Select Toolbar	70
Points & Figures	72
Points	72
Point Labels	72
Editing Single Points	72
Working with Multiple Points	72
Point Toolbar	72
Select Point Toolbar	74
Point Averaging	75

Partition Lines/Arcs	79
AutoMap Library	80
Feature List	84
Notes	86
Lines and Figures	89
Active Linework	89
Figures	91
Line Toolbar	92
Select Line Toolbar	94
Figure List	95
Using Active Figures	97
Figure Direction Marker	100
New Figure	101
Switching Active Figures	102
3-Point Arcs	104
Splines (Curvy) Figures	106
Closing Figures	107
End (complete) a Figure	108
Re-Activating Figures	108
Deleting Figures	110
Draw Option Defaults	111
Drawing Tool	113
Smart Tags	118
Main Menu	120
Project Manager	122
Settings Menu	124
Options	125
Unit Settings	140
Coordinate Systems	143
Keyboard Shortcuts	151
Language Selection	153

AutoMap Library	154
GroupCode Editor	154
Feature List Editor	161
Project Information	161
About FieldGenius	162
Measure Modes (Total Station)	164
Setup & Check	167
Backsight by 1 Point or Direction	167
Backsight Measure Modes	170
Backsight Summary	171
Multiple Backsight	174
Resection	177
Observe Benchmark	182
Check Backsight	184
Check Point	186
Temporary (No Store)	187
Sideshot	188
Sideshot (Auto Store)	189
GroupCode	190
GroupCode (Auto)	193
Multi-Set	193
Staking	199
Offsets	199
Distance Offset	199
Horizontal Angle Offset	201
Vertical Angle Offset	204
Line - Distance Offset	205
Add Invert	209
Intersections	210
Two Line Intersection	210
Line - Angle Intersection	212

Line - Perpendicular Point	213
Trilateration	216
Vertical Plane Projection	218
Point Scanning	221
Manual	233
Manual Entry	233
Manual Distance	234
Measure Modes (GNSS Reference)	235
Overview	236
Known Geodetic Position	236
Averaged Geodetic Position	237
Local Transformation to Point	238
Measure Modes (GNSS Rover)	241
Standard Measurement	242
Offset Measurement	243
Tilt Offset Measurement	246
Auto Record Points	248
Staking	249
Local Transformation Point	249
GroupCode	252
Check Point	254
Trilateration	256
Add Invert	258
Measure Modes (Disto/Laser)	260
Quick Setup	264
Backsight Baseline	265
Survey Tools	271
Store / Edit Points	272
Drawing Tool	276
Delete Last Saved Point	280
Raw File Viewer	280

COGO History Viewer	283
Traverse Report	284
Traverse Adjustment	289
GNSS Local Transformation	290
Overview	290
Transformation Setup	294
Modify Parameters	295
Modify Control	299
Bolt Patterns	302
Add Raw File Note	305
View Averaged Points	306
Calculations	307
Inverse	308
Traverse / Intersection	311
Offset Intersection	315
Station/Offset	316
Rotate/Translate/Scale Points	320
Apply User Defined Parameters	320
Apply Control Calculated Parameters	325
Curve Calculator	332
Area Calculator	334
Triangle Calculator	344
Coordinate Calculator	346
Scientific Calculator	348
Instrument Selection	355
Total Station	356
GNSS Reference / GNSS Rover	356
Disto/Laser	356
Simulators	356
GNSS Rover Demo	356
Total Station Demo	356

None	357
Staking Menu	358
Stake Points	359
Staking Toolbar	363
Stake Line/Arc	368
Stake Line	368
Stake Arc	371
Stake Alignment	372
Stake Surface	373
Stake Elevation	375
Staking List	376
Auto-Locate - Point On Wall	380
Auto-Locate - Point On Floor or Ceiling	383
Auto-Locate - Pipe Through Wall	387
Import / Export	390
Points / Observations	392
ASCII Coordinate Import	392
ASCII Coordinate Export	395
SIMA Import	399
SIMA Export	399
SDR Export	399
Fieldbook Export	400
Export CR5 (Sequential)	401
GNSS Survey Report	401
CAD / LandXML / Templates	402
DGN/DXF/DWG Import	402
DXF/DWG Export	403
LandXML Import	405
LandXML Export (Points and Chains)	408
Import Template	408
Export Template	411

Cut Sheet Reports	412
GIS Files	415
Shapefile Import	415
Shapefile Export	415
KML Export	416
Coordinate Systems	416
Data Manager Menu	418
Point Database	419
Map Data Layers	421
Surfaces	429
Import DTM Surface File (QSB)	440
Parcels Manager (XML)	441
Roads Manager	443
Manage Road	445
Manual Entry - Alignment C/L	446
Manual Entry - Vertical Profile	453
Manual Entry - Template	462
Advanced Template Editing	466
LandXML Cross Sections	472
Alignment DTM Surface	473
Alignment Staking - Part 1	474
Alignment Offset Staking	483
Alignment Slope Staking	488
Total Station Reference	495
Make and Model Settings	495
Total Station Profile	495
Model and Communication	496
Radio Configuration	498
EDM Settings	500
Measurement Tolerance	501
Search Settings	502

Conventional Total Station	504
Total Station Profile	505
Connect to Instrument	505
Getting Started	506
Robotic Total Station	506
Create Total Station Profile	506
Connect to Instrument	510
Getting Started	510
No Communication	510
Total Station Settings	510
Rotate Instrument	512
Check Level	514
Basic Measure	515
Target Manager	516
Target Manager: Backsight	516
Target Manager: Foresight	517
Prism Selection Window	519
Target List	519
New Target	521
Edit Target	522
Default Settings	523
Target Manager: Leica Instruments	526
Target Manager: Backsight	526
Target Manager: Foresight	527
Target List: Leica	529
New Target: Leica	530
Edit Target: Leica	532
Default Settings: Leica	534
GNSS Reference	537
Create/Edit GNSS Profile	537
Select GNSS Profile	537

GNSS Reference Profile	538
GNSS Rover Profile	539
GNSS Model and Communication	541
GNSS Tolerance Settings (Reference)	543
GNSS Tolerance Settings (Rover)	544
GNSS Antenna Height	547
Overview - Reference Receiver	548
Overview - Rover Receiver	549
Profile and Coordinate System Files	549
Rover Connection Procedure	550
Electronic Bubble / Tilt Survey	550
Reference and Rover Common Tools	555
Correction Link	555
GNSS RTCM Transformation	556
Correction Information	557
GNSS Satellite Plot	558
GNSS Satellite List	559
GNSS Settings	560
Sensor Information	565
Position Information	566
Raw Data Logging	567
Command Console	569
Disto/Laser Reference	571
3D Disto	571
S910 Disto	575
Bluetooth Disto	576
Connecting to Computer	577
Microsoft ActiveSync / Windows Mobile Device Center	577
Installing ActiveSync / Windows Mobile Device Center	577
Connecting ActiveSync / Windows Mobile Device Center	578
MicroSurvey Transfer	581

Synchronize	582
RAW File Reference	583
Raw File Record Types	583
Conventional Raw Data Records	583
GPS Raw Data Records	590
Index	595

GETTING STARTED

Introduction

MicroSurvey FieldGenius was designed for Land Surveying, Civil Engineering, Seismic Surveying, and Construction Staking professionals to provide unequalled data collection simplicity and field calculating performance.

The Graphic User interface allows you to build the drawing as you measure, providing you with instant visual confirmation of accurate data collection and survey calculations. It includes the ability to draw linework as you measure from point to point without the need for cumbersome line coding.

FieldGenius takes advantage of the Windows CE touch screen capability by allowing you to tap points and lines in your drawing to open toolbars with all the function you need instantly. Functions that are not available directly from FieldGenius graphics display are available from a simple main menu which is organized by task. Please spend some time looking over this document or watch our movies to become familiar with the functionality of FieldGenius.

Once you've collected your data in the field you can export it directly out of FieldGenius using many different file types such as ASCII, DXF, XML, SDR, or ESRI Shapefiles. If you have MicroSurvey CAD or inCAD desktop software, then you can read your FieldGenius projects into it directly. FieldGenius raw file is based on the popular industry-standard TDS RW5 format which means you probably already have software that can import this raw file type and process it. This means you don't need to purchase expensive products to process your FieldGenius projects.

Importing data into FieldGenius is just as easy as exporting. You can import ASCII, XML and DXF files directly into FieldGenius.

Our instrument control is easy to use and very powerful. Access to your instrument controls is available on the main interface at all times so there is no need to swap to other screens or menus.

As always, MicroSurvey welcomes your comments and suggestions for our products.

Hardware Requirements

FieldGenius can be installed on various Windows Mobile, WinCE, and Windows Tablet/PC devices. Please visit the [Hardware Support](#) page for a list of supported devices. If in doubt, please contact [Technical Support](#).

Installing FieldGenius

If you purchased a new data collector with FieldGenius, FieldGenius will most likely come pre-loaded on it.

If you are installing FieldGenius yourself onto an existing data collector, please confirm that your hardware is supported by FieldGenius. If you're reading this topic then you probably already know if FieldGenius will run on your data collector. If you're not sure, you can refer to the [hardware requirements](#) topic or call our technical support department.

To install onto your data collector you need to make sure you have a [Microsoft ActiveSync or Windows Mobile Device Center](#) connection established between your computer and your data collector.

To install FieldGenius onto your device you will need to download the installation files from our website at <http://helpdesk.microsurvey.com/>.

Starting FieldGenius

During install, shortcuts are created and will be located in either your Start Menu, or Start Menu | Programs, or directly on your desktop. Simply press the shortcut to start the program.

Auto Repair

Upon start-up FieldGenius checks the registry for corruption, and also checks to make sure important system files are where they need to be for FieldGenius to run properly. If it detects any problems, it will automatically fix them for you.

Hard Reset or Battery Drain

In these scenarios as with other software, you would usually have to re-install your software. However, because FieldGenius can repair itself all you need to do is use the File Explorer or My Computer program on your data collector to browse to where FieldGenius is installed and find the programs folder. In there, if you run the "splash" program it will automatically fix all problems and re-install your shortcuts for you.

The splash program will be an executable file and it will include the word "splash" in it. For example on a Windows Mobile device, the file is called **SplashWM6.exe**.

Registration & Demo Mode

When you start FieldGenius for the first time you will see the registration screen which will list the Device ID. This ID is unique for each device that FieldGenius is installed on.



Activation

To activate FieldGenius you need access to the Internet. With your purchase you should have received a serial number (also known as a Globally Unique ID, or GUID) that you will need along with the Device ID generated by FieldGenius.

A typical serial number will look something like the following:

D9C83164-FB0E-4713-B457-CE593EFEA296

A typical Device ID will look something like the following:

F011-F38C-4421-B482

Step 1

From a computer that has access to the internet, please visit the following web page:

www.microsurvey.com/register

Follow the instructions on the FieldGenius registration pages.

NOTE: Your GUID is valid for only one activation.

Step 2

Using the Key generated by the online registration system, enter the key values into FieldGenius.

When done, press the Apply Key. You will see the words "Activation Key Valid" and it will list the modules that were registered. The **Run Demo Mode** button will also change to say **Continue**.

More Help or Purchase

HELP: For online help, [click here](#).

To purchase FieldGenius please call MicroSurvey Software at 1-800-668-3312.

Product Registration

To receive news and notifications about your product, please register your software at:

www.microsurvey.com/reg



The screenshot shows a web form titled "Product Registration". The form contains the following text and elements:

- Product Registration** (Section Header)
- To activate the software you will require the GUID that was provided to you when you purchased the software, then open this page to activate the license:
<http://microsurvey.com/register/>
- To register your personal information with MicroSurvey to receive news and update information, please visit:
<http://microsurvey.com/reg/>
- To store your GUID serial number for future reference; please enter it in the field below and press 'Save' to save to file:
-
- 

Available Modules

There are several modules available for use on a data collector and they're as follows:

- **Standard** - Real-time Automated Linework, COGO Calculations, Traverse Closure and Adjustments, ASCII/DXF Import/Export, MicroSurvey Transfer, and more!
- **Total Station** - Adds non-robotic total station control.
- **GNSS** - adds RTK GNSS control, Coordinate Calculator, GNSS Local Transformations.
- **Advanced** - adds Surface Modeling, Roding, LandXML, GIS Attribute Collection, Pre-determined Area Calculations
- **Robotic** - adds Robotic Total Station control.
- **MEP** - adds Auto-Locate capabilities.

Run Demo Mode

To run FieldGenius in demo mode press the **Run Demo Mode** button.

In Demo mode, FieldGenius is limited to storing only 30 points each time it is run, but otherwise it is fully functional.

Retrieve Lost Key Codes (passwords)

The key code that was generated for a serial number can be accessed from the online registration page www.microsurvey.com/register. Just enter the serial number you wish to retrieve the key code for and the key code and the Device ID it is assigned to will be displayed.

Technical Support

If you need help with FieldGenius please contact [Technical Support](#).

Project Manager

[Main Menu](#) | [Project Manager](#)

The Project Manager is used to create, open, or delete Projects stored on your data collector. When you start FieldGenius this is always the first screen you will see.

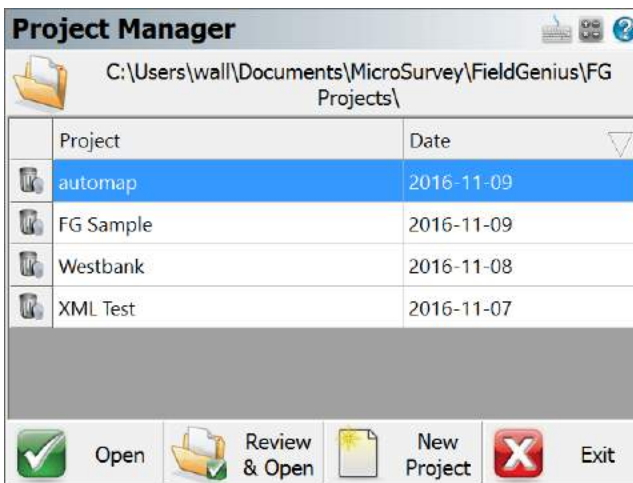

You can sort the list by Project name or date by tapping on the column's header.

FG Projects Folder

Press this button to specify a different Project folder than the default. The default is ...**MicroSurveyFieldGenius\FG Projects** (Windows CE/Mobile) or ...**Documents\MicroSurveyFieldGenius\FG Projects** (Windows Tablet/PC). Once you set the directory it is written to the MSurvey.ini file and is used for all subsequent Projects.

Delete Project

To delete a Project, pick the **Delete** trash can icon next to the Project Name. You will be asked to confirm that you really want to delete the Project.

Notes:

- You cannot delete a Project that is currently open
- Projects that have been deleted cannot be restored

Open Project

To [open an existing Project](#), simply select it in the list and press the **Open** button.

Review & Open Project

To review and open an existing Project, simply select it in the list and press the **Review & Open** button. This option will display the Project files used with the Project.

New Project

To [create a new Project](#), simply press the **New Project** button. You will then see the New Project screen which will allow you to enter a name, choose your AutoMap library and set the units for the Project.

Exit

To exit from the Project Manager press the **Exit** button.

Project Review

When you create a new Project or open an existing Project; you will have the option to review the Project Files screen.

Here you can confirm the files associated with the Project and change or add files as needed.

New Project Files: NewProject

Generate New Name

Active Raw File: Encrypted

Copy Existing: ...

Project Automap:

Use Template: ...

Feature File: ...

Continue Cancel

Set Active Raw File

This indicates the name of the raw file that is going to be used. You can select a different one by pressing the button and either generate a new raw file name or choosing an existing raw file to open. The Encrypted option indicates whether or not this raw file is encrypted. You can only change this option when creating a new Project; once set, this option cannot be undone. Encrypting the raw file ensures that users cannot accidentally or intentionally edit their raw files with a text editor or other software. The state of the encryption toggle is retained for subsequent new Projects.

Note:

At this time, no other applications besides FieldGenius 7 (or newer) and MicroSurvey CAD 2014 (or newer) can read an encrypted raw file. Previous versions of MicroSurvey CAD, inCAD, and FieldGenius will not be able to read FieldGenius encrypted raw files.

Set Project AutoMap

This indicates the AutoMap Library Template that will be loaded into the Project. You can change it by pressing the button and either choosing a different template library or creating a new blank library. AutoMap files contain pre-defined descriptions that can be used in FieldGenius. The template library that you select will be copied into the Project's folder with a name of ProjectName_automap.csv, and any changes that you make to the AutoMap Library will affect only the Project library, not the template library.

Set Feature File

Use this to select a feature list that you want to use with the Project, for collecting GIS point attributes.

Quick Start: Open Existing Project

Start FieldGenius by running the icon contained either in your Start Menu or on the Desktop of your data collector.

If you start FieldGenius in demo mode, the first screen you will see is the [About screen](#), where you can enter a registration code to license your copy of FieldGenius. Press the **Run Demo Mode** button if you see this screen.

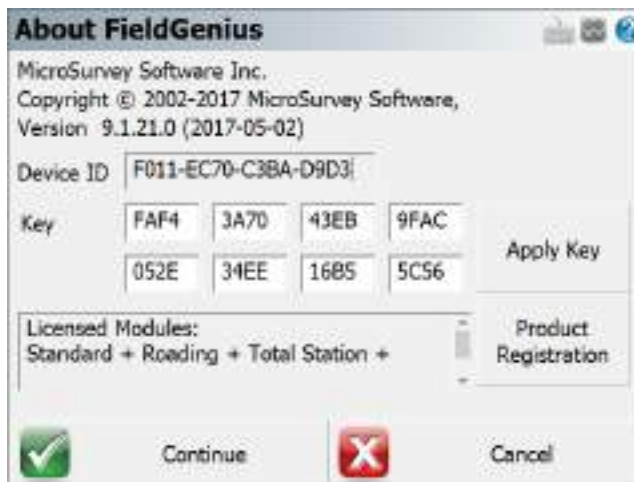

By default a Project named **FG Sample** is installed. For this example let's open it by highlighting it and pressing the **Open** button. You can also double tap the file name which will also open it. Use the **Review & Open** button to also review the Project files of the Project.

If you picked the **Review & Open** option; you will be able to review the Project files associated with the Project and make any changes if needed.

Open Project Files: FG Sample

Generate New Name

Active Raw File: FG Sample.raw Encrypted

Copy Existing: ...

Project Automap: FG Sample_automap.csv

Use Template: survey.csv ...

Feature File: ...

Continue Cancel

FieldGenius will then check to see if the Project has a previous instrument setup. If one is found you will be asked if you would like to reuse it.

The main menu will then be displayed. Press the button to access the map screen, or use any of the available menu commands.

Quick Start: New Project

Start FieldGenius by running the icon contained either in your Start Menu or on the Desktop of your data collector.

When you start FieldGenius in demo mode the first screen is the [About screen](#), where you can enter a registration code to license your copy of FieldGenius. Press the **Run Demo Mode** button if you see this screen.

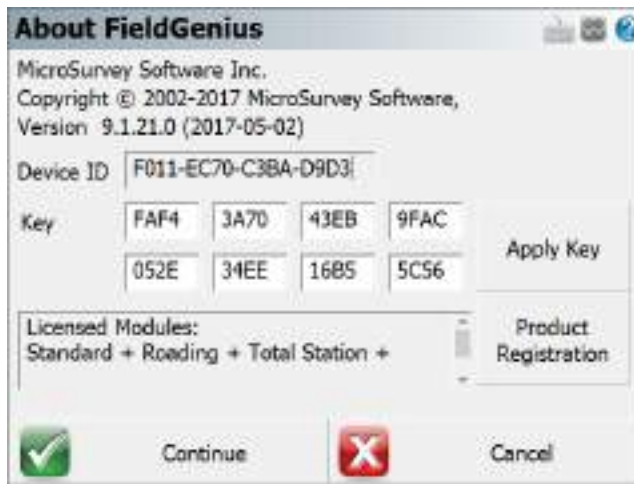

Next, the Project Manager appears. Press the **New Project** button to create a new Project.

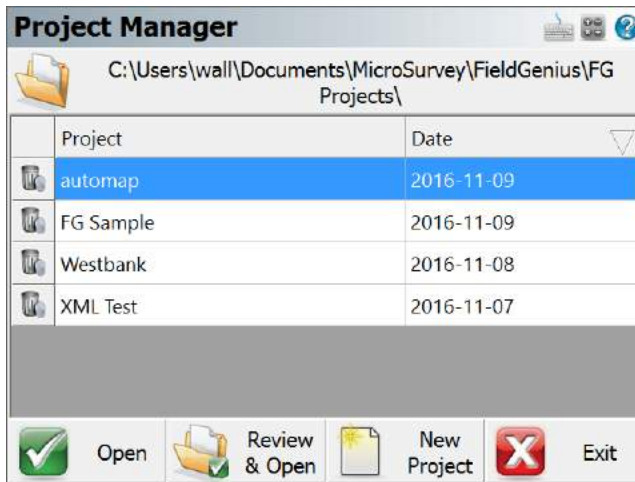

Enter a name for your new Project. You can press **OK** to accept the settings and continue. If you need to change any of the settings, press the **Project Settings** button.

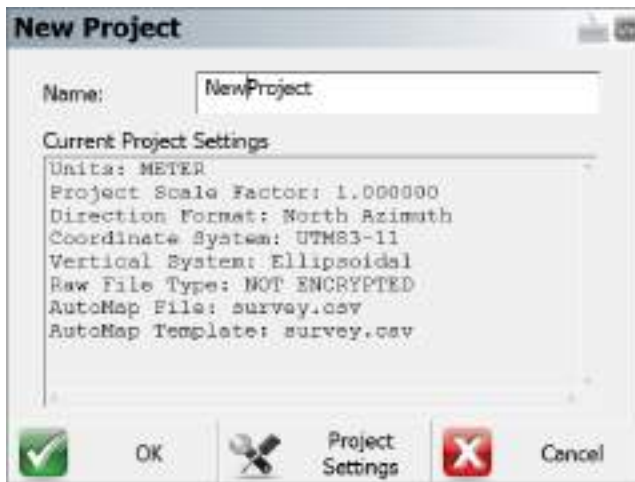

Project Settings

The Project Setting screen allows you to refine the various aspects of the Project and save them as default for future Projects if desired.

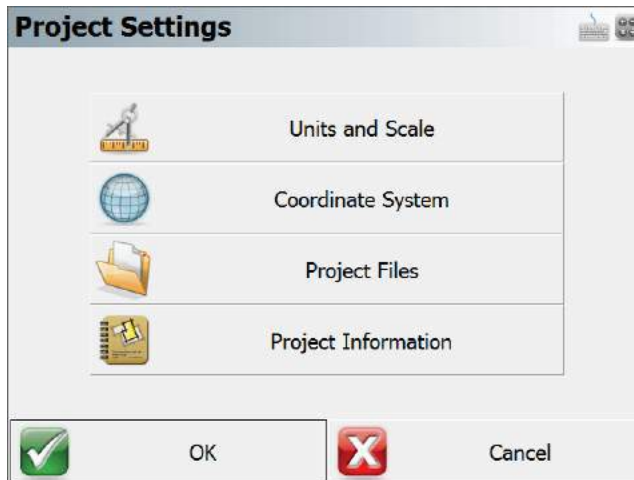

Units and Scale

In the [Units and Scale](#) screen, you can specify the units for your Project. Set them as desired, then use the **Save As Default** button to set these settings as defaults for all subsequent new Projects.

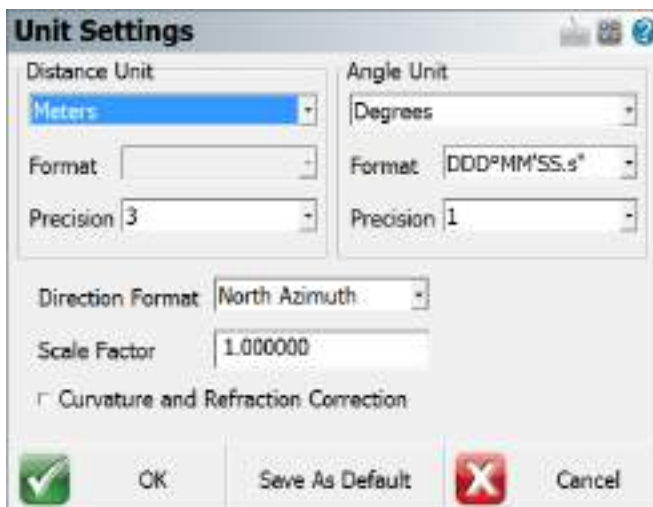

Coordinate System

The [Coordinate System](#) screen allows you to select Horizontal and Vertical coordinate systems. These settings are critical for working with GNSS equipment. Use the **Save As Default** button to set these settings as defaults for all subsequent new Projects.

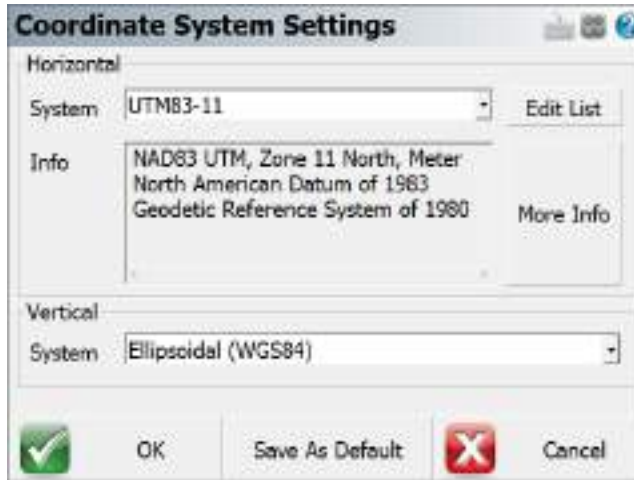

Project Files

The [Project Files](#) screen allows you to specify the Raw File, the AutoMap Library Template File, and Feature List File to use, and whether you want your raw file to be encrypted and/or appended.

New Project Files: NewProject

Generate New Name

Active Raw File: Encrypted

Copy Existing: ...

Project Automap:

Use Template: ...

Feature File: ...

Continue Cancel

Project Information

The [Project Information](#) screen allows you to enter information about the Project, crew and weather conditions.

Project Information

Crew Members

Instrument

Serial Number

Temperature

Pressure

PPM

Note 1

Note 2

OK Cancel

Press **OK** on the New Project screen. You will then see the [Instrument Selection](#) screen where you are prompted to select the instrument that you want to connect to. Let's set it to **Simulator** and select **Total Station Demo** in the Instrument Profile drop down box. Then press **Connect** to continue. (Note, you will not see this screen if FieldGenius is running onboard your instrument.)



If you selected Total Station or Total Station Demo, you will then see a message asking "**Would you like to create a new point now?**" Press **Yes** to open the [Store / Edit Points](#) screen. The default coordinates that are displayed are retrieved from the MSurvey.ini file and if you change these coordinates they will be remembered for next time. Selecting **No** will take you to the main interface.

Store Point

Point ID: 1

Description: SPK

Northing: 100.000m

Easting: 100.000m

Elevation: 100.000m

Store As: User Point

Buttons: Review Measurement, GIS Attributes, Advanced, Enter Note, Store Pnt, Cancel

If you chose to create a reference point in the step above, you will be asked **"Would you like to setup the instrument at the new point?"** Press **Yes** to open the **Orientation Setup** screen for measuring your backsight.

Orientation Setup

Instrument

Occupy Point: 1

Instrument Height: 0.000m

Backsight

Backsight Point: []

Backsight Direction: 0°00'00"

Backsight Distance: []

Target Manager: 0.000m

Buttons: OK, Cancel

Once you complete the setup routine and have measured your backsight, you will see your setup and backsight positions in the [map view](#).

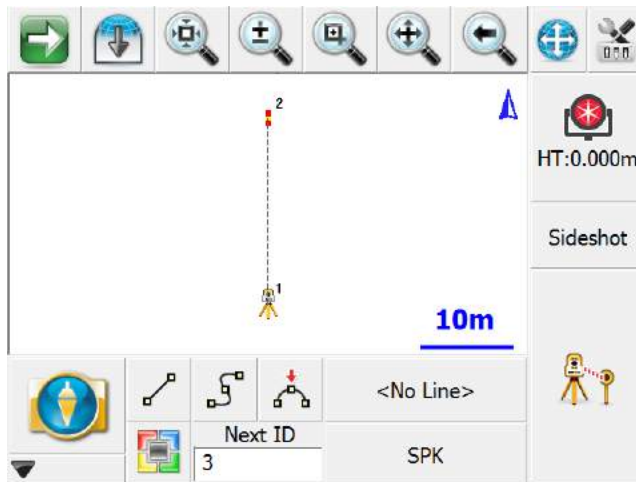

Common FieldGenius Buttons

The FieldGenius interface has a consistent structure and to use it effectively the user needs to become familiar with several commonly used buttons.



Clicking on this button will open up the [keypad](#).



Clicking on this button will open up the Windows Start Menu. Available on Pocket PC and Windows Mobile devices only.



Clicking on this button will open up the [RPN Calculator](#).



Clicking on this button will open up the help page for whatever topic you are currently at. The help page will open up in an Internet Explorer window.



This button will take you back to the previous menu until you are back at the [main menu](#).



This button will take you back to the [map screen](#).

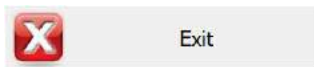

This button will save your Project and close FieldGenius.



This button will accept the input or changes, then continue to the next screen or finish the command.

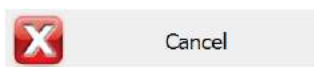

This button will close the current screen and return you to the previous screen without saving any changes.



Pressing this will close the currently open toolbar and return you to the previous screen.



Pressing this will open the [Point Chooser toolbar](#).

FieldGenius Project Files

Every FieldGenius Project will contain usually 7 files, but may contain more depending on what files you've exported or copied to the directory. Typically you will see that the file names will begin with the name of your Project.

Filename.cdx	This is the index for the database file.
Filename.dbf	This is the database file that contains your coordinate information.
Filename.ini	This file contains information pertinent to your Project.
Filename.raw or File- name.rae	This is the raw file that contains your observations. If the raw file is encrypted it will have a .rae extension. Note you can have more than one raw file.

Filename_figures.dbf	This is the database for your figures in your Project.
Filename_figures.cdx	This is the index file for the figures database.
Filename_automap.csv	This is the AutoMap Library for your Project.

When you create a new Project, the Project name that you use will become the "folder" for your Project files. By default, your Project will be stored in the ...\\MicroSurvey\\FieldGenius\\FG Projects\\ (Windows CE/Mobile) or ...\\Documents\\MicroSurvey\\FieldGenius\\FG Projects\\ (Windows Tablet/PC) directory.

Note:

After creating a new Project, do not later rename the folder containing your Project's files or the actual files, doing so will cause FieldGenius to not recognize the folder as a valid Project and you will not be able to open it.

Automatic Save

There are a few things to keep in mind when manually entering data in FieldGenius:

All stored data is automatically saved. There is no need for a Save function. Always close the program by going to the [Main Menu](#) and choose the Exit button to prevent loss of measurement data.

Input fields that are left blank are stored as undefined. For example, if you enter only a horizontal coordinate for a point and leave the elevation field blank, we do not automatically set the elevation as 0.000. The elevation remains undefined.

Data Entry (Extended Edit Fields)

Throughout FieldGenius you will see edit fields for entering various values. These types of fields are called Extended Edit Fields, and can be used not only for typing values, but can also launch related commands such as the keypad, calculator, point chooser, inverse tool, etc. This type of functionality is unique to FieldGenius.

You can control how these Extended Edit Fields will be triggered by changing the "Extended Edit Boxes" option in the [Options](#) screen to require a single tap, a double tap, or to disable them so that you can only type values into them.

Text Entry

For most text entry fields in the program, tapping in it will open up the [keypad](#).

On Windows Mobile devices you can select which keypad to display by changing the "SIP Type" option in the [Options](#) screen.

Points

When you see an extended edit field for a Point ID, tapping in it will open the [point chooser toolbar](#).

Distance and Angles

Tapping in other numeric fields such as those for directions and distances will open the [RPN Calculator](#), and some distance fields will open the [Inverse](#) tool.

Multi-function Fields

Some fields will display a pop up menu if multiple functions can be opened from that field, just select the desired function from the list.

Keypad

The keypad can be opened from any [extended edit entry field](#). This provides a method of easy text and numeric entry on devices that do not have a physical keypad but it can be used on any device.



Calculator

The RPN [Scientific Calculator](#) can be called up from the keypad by pressing the **Calculator** button. If you press the Calculator button, the value entered in the keypad entry field will be copied to the calculator's command line (Note, it must be a numeric value, alpha portions will be stripped off in the calculator) where it can be used for any calculations. When you are done with the calculator, pressing the **OK** button will return the result back into the keypad.

OK

Pressing the **OK** button will close the keypad, and set the entered value into the text field from which the keypad was opened.

Cancel

Pressing the **Cancel** button will close the keypad without setting anything into the text field from which the keypad was opened.

Keypad Settings

There are five important settings related to the keypad, which are both found by to going to Settings and then the Options button that takes you to the [Options](#) screen.

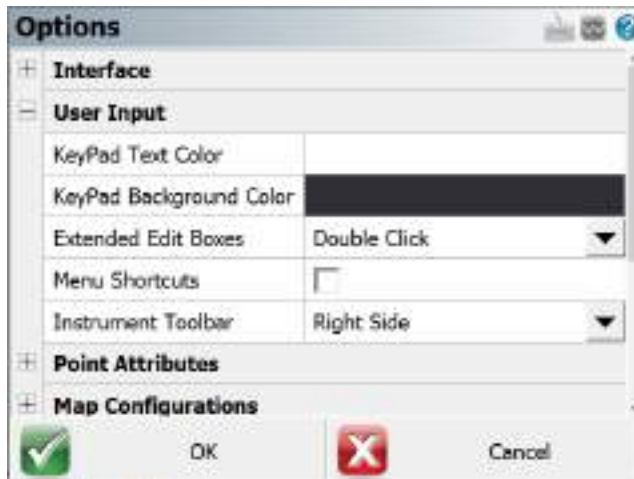

Virtual Keyboard

Use this to specify which keypad type you want to use. Not all keyboard types are available on all data collectors.

Extended Edit Boxes

Use this to control how you want to bring up the selected keypad when tapping in an edit box: either with a single tap, a double tap, or off. Users of devices with a keyboard should leave this set to Single Click, and users of devices without a keyboard should set this to Double Click. Setting this to Off disables both the keypad and any other commands that may be started directly from the extended edit field, such as the Point Chooser or Inverse Tool, so that edit fields can only be used for typing values from your physical keypad.

Keypad Text Color

Use this setting to customize what color the alphanumeric keyboard text will use. By adjusting the color of the keypad text, this can greatly increase the visibility and overall contrast of the onscreen keyboard in high and low light conditions.

Keypad Background Color

Use this setting to customize what color the alphanumeric keyboard's background will use. By adjusting the color of the background, this can greatly increase the visibility and overall contrast of the onscreen keyboard in high and low light conditions.

Instrument Toolbar

Use this setting to customize what side of the map screen the instrument tool bar is displayed on.

Distance Entry & Recall

Distance Entry

You can customize FieldGenius to work with the direction input of your choice. See the [Units & Scale](#) topic for details.

The number you enter is assumed to be in the same units as your Project, unless a unit modifier is specified (see below). So 5.25 would be interpreted as 5.25 feet, or 5.25 meters depending on your Project's default unit setting.

Distance Recall

You can recall the distance between two points, by inputting in the form: **FromID..ToID** Example: 26..84 will be recognized as the distance computed between points 26 and 84. The distance will be returned in whichever format your units settings is set to.

Unit Modifiers

Recognition of the unit symbols m, ', ft, usft, ftus are supported, and can be used to override the Project's unit settings.

Meters

You can specify that a distance is in meters by entering "m" after the value, for example 100m means 100 Meters, even if your Project is in Feet. Therefore, if your Project is in US Feet and you enter 100.00m in a distance field, you will see it automatically get converted to 328.08 feet.

Feet (International or US Survey)

The ' symbol will be interpreted as either International Feet or US Survey Feet, whichever units the current Project is in. For example, entering 1000' will match the feet units that your Project is in, so it can mean either 1000 International Feet or 1000 US Survey Feet. If your Project is in meters, then the ' symbol is interpreted as International Feet.

Fractional Feet

When entering distances in a fractional format, use a ' symbol or a space between the feet and inches values to separate them. A " symbol is not required. For example, you can enter 10'6 or 10 6 which both mean 10'6". You can enter fractional inches by placing a space between the whole and fractional inches, and using a / symbol in the fraction. For example, 10'6 1/2 or 10 6 1/2 both mean 10'6.5". You can also enter decimal values, such as 10.5' to mean 10'6" or 10'6.5 (or just 10 6.5) to mean 10'6 1/2".

International Feet

You can specify that a distance is in International Feet by entering "ft" after the value, for example 1000ft means 1000 International Feet.

US Survey Feet

You can specify that a distance is in US Survey Feet by entering "usft" or "ftus" after the value, for example 1000usft and 1000ftus both mean 1000 US Survey Feet.

Distance Entry Examples

Project Units:	International Feet	
Format:	Decimal	
User Entered Value:	Interpreted As:	Result (always matches Project units):
1000.23	1000.23 in Project units	1000.23'
1000.23'	1000.23 in Project units	1000.23'
1000.23usft 1000.23 usft 1000.23ftus 1000.23 ftus	1000.23 US Survey Feet	1000.25'
20.117m	20.117 meters	66.00'

20.117 m		
10000m 10000 m	10000 meters	32808.40'
10 6 10'6 10'6"	10 feet 6 inches	10.50'
10 6 1/2 10'6 1/2	10 feet 6.5 inches	10.54'

Project Units:	US Survey Feet	
Format:	Decimal	
User Entered Value:	Interpreted As:	Result (always matches Project units):
1000.23	1000.23 in Project units	1000.23'
1000.23'	1000.23 in Project units	1000.23'
10000.23usft 10000.23 usft 10000.23ftus 10000.23 ftus	10000.23 US Survey Feet	10000.23'
10000.23ft 10000.23 ft	10000.23 International Feet	10000.21'
20.117m 20.117 m	20.117 meters	66.00'
10000m 10000 m	10000 meters	32808.33'
10 6 10'6 10'6"	10 feet 6 inches	10.50'
10 6 1/2 10'6 1/2	10 feet 6.5 inches	10.54'

Project Units:	Meters
Format:	Decimal

User Entered Value:	Interpreted As:	Result (always matches Project units):
1000.23	1000.23 in Project units	1000.23m
1000.23'	1000.23 International Feet	304.870m
10000.23usft 10000.23 usft 10000.23ftus 10000.23 ftus	10000.23 US Survey Feet	3048.076m
10000.23ft 10000.23 ft	10000.23 International Feet	3048.070m
20.117m 20.117 m	20.117 meters	20.117m
10'6	10 feet 6 inches	3.200m
10'6 1/2	10 feet 6 1/2 inches	3.213m
10 6	Not allowed, must enter units for feet such as 10ft 6, or 10usft 6.	
10 6 1/2	Not allowed, must enter units for feet such as 10ft 6 ½, or 10usft 6 ½.	

Using Math Operations

Math operators are now supported again. You are now permitted to use math operators in distance fields.

User Entered Value	Interpreted As	Result if Project Units Set to Feet	Result if Project Units set to Metric
3.5/2+1.2	3.5 divided by 2 plus 1.2	2.95 feet	2.950 metres
1..2/2+10 (assume 1..2 = 10)	((Distance from point 1 to 2) divided by 2) plus 10	15.00 feet	15.000 metres
8' + 3'	8 feet plus 3 feet	11.00'	3.353m
1'+2 3'+1m	1 foot plus 2 feet 3 inches plus 1 metre	6.53'	1.991m

NOTE: If your Project is set to feet and you enter 2 3 (2 space 3), this will be interpreted as 2 feet 3 inches. This occurs if your Project is set to either decimal or fractional feet.

You can also use the RPN Calculator to further manipulate distance values. For example, if you want to find the distance halfway between points 1 and 2, enter 1..2 into the distance field to recall that distance. Then double tap on that extended edit field to pull that recalled distance into the calculator, where you can divide the distance by 2 (or perform any other calculations with it). Then press the **OK** button in the calculator to copy the result back into the field you started from.

Direction Entry & Recall

Direction Entry

You can customize FieldGenius to work with the direction input of your choice. See the [Units & Scale Settings](#) topic for details.

To enter an angle using the format selected in your units settings, simply enter the angle. For example, 120.4530 means 120°45'30" if your Project is in Degrees/Minutes/Seconds, 120°45.3' if your Project is in Degrees/Minutes, or 120.453° if your Project is in decimal degrees.

Direction Recall

You can recall the direction between two points, by inputting in the form: **FromID..ToID** Example: 26..84 will be recognized as the direction computed between points 26 and 84. The direction will be returned in whichever format your units settings is set to.

Unit Modifiers

You can always override your Project's units setting by entering the bearing with the cardinal quadrant indicated before or after the direction. If there is no quadrant specified, then the input direction will be interpreted as an Azimuth.

Decimal Degrees

You can always specify that an angle is in decimal degrees by entering "d" after the value, for example 45.5083d means 45.5083° or 45°30'30".

Degrees, Decimal Minutes

You can always specify that an angle is in degrees and decimal minutes by entering "dm" after the value, for example 45.305dm means 45°30.5' or 45°30'30".

Degrees, Minutes, Decimal Seconds

You can always specify that an angle is in degrees, minutes, and decimal seconds by entering "dms" after the value, for example 45.3030dms means 45°30'30".

Bearings

To enter a bearing, use the cardinal quadrant letters (N, E, S, and W) before or after the angle. For example: NE60.4530, 60.4530NE, or N60.4530E means NE 60°45'30" if your Project is in DMS, NE 60°45.3' if your Project is in DM, or NE 60.453° if your Project is in decimal degrees. It does not matter if you have spaces between the quadrant designation and the angle. You can also separate the degrees, minutes, and seconds values with a space. For example, N 60 45 30 E or N60.4530E both mean NE 60°45'30". You can of course also use any of the "d", "dm", or "dms" (or "g" or "r", see below) designators with a bearing entry, such as NE45.305dm to mean N 45°30'30" E.

Gons (Gradients)

You can specify that an angle is in Gons/Gradients by entering "g" after the value, for example 100g means 100 Gradients (equals 90 degrees).

Radians

You can specify that an angle is in Radians by entering "r" after the value, for example 1.57r and means 1.57 Radians (approximately 90 degrees).

Project set to Azimuth

Direction Entry Examples

Angle Units:	Degrees	
Format:	DDD°MM'SS.s"	
Format:	Azimuth	
User Entered Value:	Interpreted As:	Result (always matches Project units):
90.5016	90 degrees, 50 minutes, 16 seconds	90°50'16"
NE45.3030 NE 45.3030 N45.3030E N 45.3030 E 45.3030NE 45.3030 NE	North East quadrant, 45 degrees, 30 minutes, 30 seconds	45°30'30"

SE45.3030 SE 45.3030 S45.3030E S 45.3030 E 45.3030SE 45.3030 SE	South East quadrant, 45 degrees, 30 minutes, 30 seconds	134°29'30"
SW45.3030 SW 45.3030 S45.3030W S 45.303 W 45.3030SW 45.3030 SW	South West quadrant, 45 degrees, 30 minutes, 30 seconds	225°30'30"
90.5016dm 90.5016 dm	90 degrees, 50.16 minutes	90°50'10"
90.5016d 90.5016 d	90.5016 degrees	90°30'06"
100g 100 g	100 gradians	90°00'00"
100.2345g 100.2345 g	100.2345 gradians	90°12'40"
3.141593r 3.141593 r	3.141593 radians	180°00'00"

Project Set to Bearings

The angle codes below provide versatile direction input.

When your Project is set to **Bearings**, you are permitted to use numeric and alpha character codes for angle and direction input.

1 or NE = North East bearing

2 or SE = South East bearing

3 or SW = South West bearing

4 or NW = North West bearing

Angle Units:	Degrees	
Format:	DDD°MM'SS.s"	
Format:	Bearing	
User Entered Value:	Interpreted As:	Result (always matches Project units):
90.5016	90 degrees, 50 minutes, 16 seconds azimuth	S89°09'44"E
NE45.3030 NE 45.3030 N45.3030E N 45.3030 E 45.3030NE 45.3030 NE	North East quadrant, 45 degrees, 30 minutes, 30 seconds	N45°30'30"E
SE45.3030 SE 45.3030 S45.3030E S 45.3030 E 45.3030SE 45.3030 SE	South East quadrant, 45 degrees, 30 minutes, 30 seconds	S45°30'30"E
SW45.3030 SW 45.3030 S45.3030W S 45.303 W 45.3030SW 45.3030 SW	South West quadrant, 45 degrees, 30 minutes, 30 seconds	S45°30'30"W
90.5016dm 90.5016 dm	90 degrees, 50.16 minutes azimuth	S89°09'50"E
90.5016d 90.5016 d	90.5016 degrees azimuth	S89°29'54"E
100g 100 g	100 gradians	S90°00'00"E
100.2345g 100.2345 g	100.2345 gradians	S89°47'20"E

3.141593r	3.141593 radians	S0°00'00"W
3.141593 r		

Using Math Operations

You can then use the calculator to further manipulate the angle. For example, if you want to determine 1..2 then add 90 degrees, enter 1..2 to recall that angle. Then double tap in the extended edit field to pull that recalled angle into the calculator, where you can add 90 to it (or perform any other calculations with it).

Note: You can perform advanced direction recall functions that include math operators directly in a direction field. For example, 1..2+90 is a valid entry. In this example the direction between points 1 and 2 will have 90 degrees added to it (if Project is in degrees).

Math operations can also be done using the RPN calculator. Please refer to the [Calculator](#) section for more information on performing specific math operations.

MAIN INTERFACE

The FieldGenius interface is separated into various toolbars which contain common functions or tools that the user will use most often.

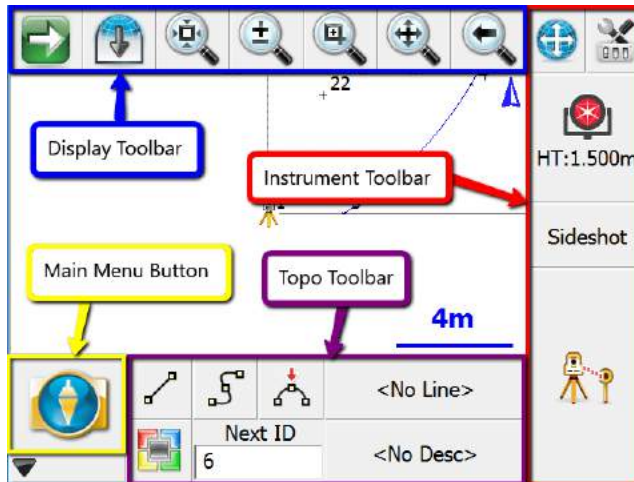

[Display Toolbar](#)

[Instrument Toolbar](#)

[Topo Toolbar](#)

[Mini Toolbar button](#)

[Main Menu button](#)

Two Versions of the User Interface

There are two versions of the user interface depending on which handheld device you're using. Some devices have a landscape screen orientation, and have the advantage of a physical keyboard. Others have a portrait screen orientation, and utilize a virtual on-screen keyboard. Note that the function of both versions is essentially the same.

Portrait Display

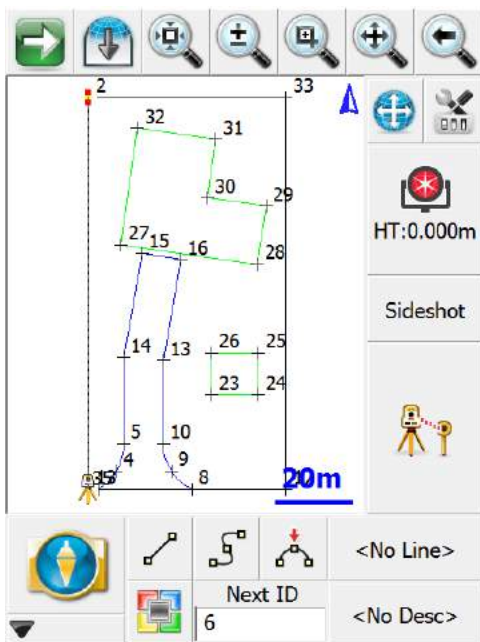

Landscape Display

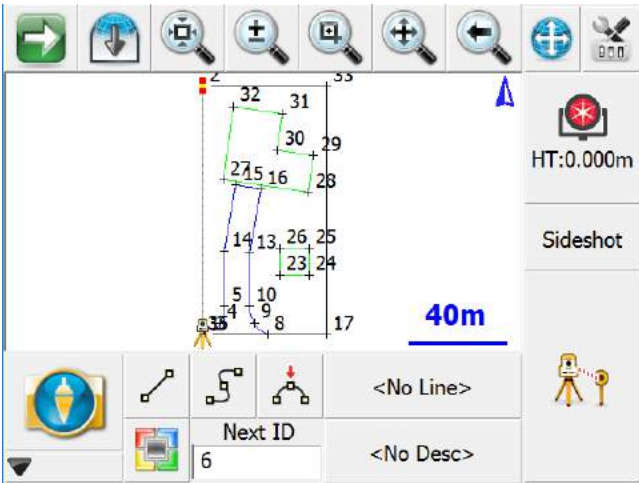

Toolbars

Display Toolbar



The display toolbar, located at the top of the map screen, is used to zoom, pan, change 3D perspectives, and for displaying information.



Next, Previous

These switch to the next or previous set of buttons.





Observation

This opens or closes the [Observation Toolbar](#). Many different functions in FieldGenius will display information in this toolbar, such as when you select a point on the screen, the point's coordinates are displayed in this toolbar.



Zoom Extents

This is a zoom extents which will zoom to the extents of your Project.



Dynamic Zoom

This is a dynamic zoom. When enabled, drag from top to bottom of the screen to zoom out, or bottom to top of the screen to zoom in. Or, when enabled, you can also use the arrow keys on your keypad to zoom in and out in the map.



Zoom Window

This is a zoom window. When enabled, drag on the map screen to define a zoom window.



Dynamic Pan

This is a dynamic pan. When enabled, you can drag across your map screen to pan around your Project. Or, when enabled, you can use the toggle or arrow keys on your keypad to pan around.



Zoom Previous

You can use this to zoom back up to 10 previous views. This includes zoom and pan changes.



World Button

It is used by the Staking commands to hide unrelated points and lines in your map during stakeout.



3D View

This opens the [3D View Toolbar](#).



3D View - Full Screen

When using the full screen mode for FieldGenius this will allow you to rotate your Project in a 3D perspective. To return to plan view, press the Zoom extents button.



Grid Display

When using the full screen mode for FieldGenius this will allow you to toggle the display of a grid on your map screen, and configure the grid settings..



Layers Manager

This opens the [Layers Manager](#) for managing visibility of layers in your database, DXF Layers, LandXML elements, and Raster Images.



Surface Manager

This opens the [Surface Manager](#) for importing and displaying DTM surface models (TIN, TGRID, or Contours) and for computing Volume Calculations.



Options

This opens the [Options](#) screen, and will automatically expand the Map Configuration section for quickly turning on or off the ID, description, and elevation labels for your points.



Help

This opens the Help topic for the current toolbar(s) visible on your screen. If there are multiple toolbars visible, you are prompted to select the help file based on the position of the toolbar: Top, Side, or Bottom Toolbar. The help file will open up in your default web browser such as Internet Explorer .

Observation Toolbar

Display Toolbar | [Observation Results](#) button



You can access the Observation Toolbar by tapping on this icon in the [Display Toolbar](#).

Total Station Observations

Total Station users can toggle through the following information:

- Horizontal Angle (HA), Vertical Angle (ZA), and Slope Distance (SD)
- Horizontal Angle (HA), Horizontal Distance (HD), and Vertical Distance (VD)
- Northing (N), Easting (E), and Elevation (H)

If using a conventional (non-robotic) total station, the observations displayed in the toolbar will be from the last measurement taken with FieldGenius.

If using a robotic total station, the observations displayed in the toolbar will continually update in real time.

GNSS Observations

GNSS users can toggle through the following information:

- Latitude (Lat), Longitude (Lon), and Geodetic Height (h)
- Northing (N), Easting (E), Orthometric Height (H)
- Standard Deviation Horizontal (SD H), Standard Deviation Vertical (SD V), and Positional Dilution of Precision (PDOP).
- Velocity (SOG) and Heading (COG) of the GNSS receiver as well as current UTC Time.

If using GNSS, the observations displayed in the toolbar will continually update in real time.

Display Size +/-

By tapping on the + and - buttons on the screen you can increase or decrease the displayed font size/-text for easier viewing.

Page Toggle

The **Page** button allows you to swap between pages changing the displayed observation information.

3D View Toolbar

The 3D View toolbar is used to help you view your Project in a 3D perspective. You can also define a virtual grid that will displayed in the drawing and can be turned on and off.

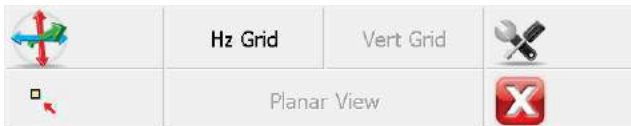

To turn this feature on select the 3D View button on the [Display toolbar](#). When you do this the 3D View Toolbar will appear at the bottom of your screen. The buttons on the toolbar are described below.



3D View

When this is turned on you will be able to rotate your Project in a 3D perspective. This tool is handy when used in conjunction with surfaces, road alignments, or [vertical projections](#). To return to plan view, close the 3D View toolbar and press the Zoom Extents button. It can also help you find points that have incorrect elevations.

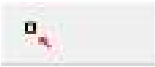

Center on Point

Use this to center the view on the selected point. This will not change your current view rotation or zoom depth.

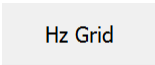

Hz Grid

Use this to turn on a horizontal grid that will be displayed in your drawing. You can set the grid spacing in the settings.

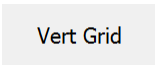

Vert Grid

Use this when using the [Vertical Projection](#) tool to turn on a vertical grid that will be displayed in your drawing. You can set the grid spacing in the settings.

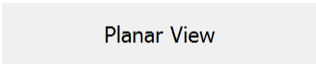

Planar View

Use this when using the [Vertical Projection](#) tool to set the view perpendicular to the vertical plane, so that the wall or other projected plane is displayed face-on in the map view.



Grid Settings

Use this to set parameters that affect the grid spacing and origin. You can select the grid origin using a point chooser and specify lengths for the sides. You can also specify the interval for each axis.

Total Station Toolbar



When FieldGenius is connected to a Total Station or the Total Station Demo profile, you will see this toolbar on the side of the map area. A [User Input](#) option determines which side of the map area the toolbar is on.

This toolbar allows you to control your [instrument settings](#), target heights, and [Measure Modes](#), as well as initiating a measurement.



[Auto-Center](#)

This toggles the auto-center feature on or off. If turned on, whenever you take a measurement, the map screen will always re-center on the measured point.



[Instrument Settings](#)

This opens the [Total Station Settings](#) screen where you can control specific settings for your total station such as EDM settings, Tolerance setting and Instrument Connect/Disconnect.



[Target Manager](#)

Press this button to access the [Target Manager](#). Here you can set target heights and create, edit, copy, and delete targets.

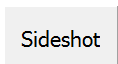

[Measure Mode](#)

This opens the [Measure Modes](#) screen where you can select what type of measurement you want to take. The current Measure Mode is always displayed on this button - for example if you're using the distance offset mode it will display "Dist Off".

Measure Button



This triggers your total station to take a measurement.

See also:

- The [Robotic Total Station Toolbar](#) topic
- The [GNSS Toolbar](#) topic
- The [Disto/Laser Toolbar](#) topic

Robotic Total Station Toolbar



When you use FieldGenius in robotic total station mode, you will see this toolbar on the side of the map area. A [User Input](#) option determines which side of the map area the toolbar is on.

This toolbar allows you to control your [instrument settings](#), target heights, and [Measure Modes](#), as well as initiating a measurement.

The current state of the instrument target aiming settings are displayed, and you are able to toggle the instrument target aiming settings between Manual and LOCK states. With LOCK enabled, **Search** and **Search Next** functionality is available for some instruments.

LOCK mode, not following a prism



These buttons indicate that the instrument is in LOCK mode, however not currently following a prism.

- **Single Tap** - Begin PowerSearch to search for prism. The left button starts a clockwise search, the right button starts a counterclockwise search.



Searching

This button indicates that a target search is in progress.



LOCK mode, following a prism

These buttons indicate that the instrument is in LOCK mode, and following a prism.

- **Single Tap** - Break Prism Lock
- **Double Tap** - Start search for next Prism. Same action on both buttons.



Cursor Tracking

Toggle Cursor Tracking. When enabled, the instrument makes continuous measurements and the current position of the target will be displayed on the screen in real time. When stationary, the cursor is a hollow triangle pointing towards the instrument. When moving, the cursor is a solid triangle pointing in the direction of travel.



Instrument Settings

Opens the [Total Station Settings](#) screen, where you can control specific settings and features for your total station.



Target Manager

Opens the [Target Manager](#) where you can set the target, target height and EDM mode.

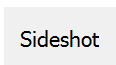

Measure Mode

Opens the [Measure Modes](#) screen where you can select what type of measurement you want to take. The current Measure Mode is always displayed on this button - for example if you're using the distance offset mode it will display "Dist Off".



Measure Button

Measure and store distances and angles. The current state of Manual / ATR / LOCK mode determines the sequence of events:

- **Manual mode** - The instrument starts a measurement immediately.
- **LOCK mode, not following a prism** - The instrument first searches for a prism and takes a measurement only if a prism is found.
- **LOCK mode, following a prism** - The instrument starts a measurement immediately.
- **ATR mode** - The instrument first searches for a prism and takes a measurement only if a prism is found.

If you are using a conventional non-robotic total station, please see the [Instrument Toolbar](#) topic.

If you are using GPS, please see the [GNSS Toolbar](#) topic.

GNSS Toolbar



Once the user has selected a GNSS receiver and communication has been established, the GNSS toolbar will appear on the [main interface](#).

NOTE: You will only see the GNSS toolbar if you selected GNSS Reference, GNSS Rover, or GNSS Rover Demo as your instrument type. If you have selected a GNSS Profile but are not yet connected to the receiver, most of these buttons will be disabled.



Auto-Center

Single-tapping this button will re-center the display on the current position of your receiver.

Double-tapping this button will set the system into an auto-pan mode where the display will always be centered on the current position. When active, single-tapping this button once more will disable the auto-pan mode.



GNSS Settings

If you press this button while you are connected to a receiver, you will see the [GNSS Settings](#) screen. At any time this button can be used to adjust or stop your GNSS survey.

If you press this button without being connected to a receiver, you will see the [Instrument Selection](#) screen where you can edit your GNSS profiles or connect to your receiver.

DOP Values

PDOP
2.2

This displays the current DOP (Dilution of Precision) values. Pressing this button will cycle through the PDOP, HDOP and VDOP. The PDOP is the default setting as this is most often used to ascertain the quality of the satellite geometry.



Satellite Plot/Satellite List

This shows the total number of satellites the receiver is currently using in its solution. Press this to view a [sky plot](#) of the current SVs visible to the rover, or to access the [Satellite List](#).

Standard
Measure

Measure Mode

This opens the [Measure Modes](#) screen where you can select what type of measurement you want to take. The current Measure Mode> is always displayed on this button.



Measure

This is the measure button.

This button also indicates the current solution type. This tells the user if the solution is Fixed, Float, WAAS, DGPS or Autonomous. This button will also indicate to the user if the corrections from the reference station have been discontinued by denoting "No Link".

Please refer to the [GNSS Measurement](#) topic for more information.

See also:

- The [Total Station Toolbar](#) topic
- The [Robotic Total Station Toolbar](#) topic
- The [Disto/Laser Toolbar](#) topic

Disto/Laser Toolbar



When FieldGenius is connected to a Disto/Laser device, you will see this toolbar on the side of the map area. A [User Input](#) option determines which side of the map area the toolbar is on.

This toolbar allows you to control your instrument settings, target height, device toggles, and [Measure Modes](#), as well as initiating a measurement.



Auto-Center

This toggles the auto-center feature on or off. If turned on, whenever you take a measurement, the map screen will always re-center on the measured point.



Instrument Settings

This opens the instrument settings screen where you can control specific settings for your Disto/Laser.

HT:0.000m

Target Manager

Press this button to access the [Target Manager](#). Here you can set the target height.



Laser Toggle

Press this button to toggle the state of the red laser pointer.



Map Toggle

Press this button to toggle between the map view or live video stream. NOTE: The live video stream is only available on supported devices, such as the Leica 3D Disto.



Zoom Controls

Zoom in and out on the live video stream view. NOTE: The live video stream is only available on supported devices, such as the Leica 3D Disto.



Crosshair Toggle

Press this button to toggle the crosshair presence on captured images that are stored.



Photo Note Toggle

Press this button to toggle whether a photo note is automatically stored when a point is measured and stored. The photo can have a crosshair showing the measurement point, depending on the crosshair toggle.



Measure Mode

This opens the [Measure Mode](#) screen where you can select what type of measurement you want to take. The current Measure Mode is always displayed on this button - for example if you're using the distance offset mode it will display "Dist Off".



Measure Button

This triggers your device to take a measurement.

See also:

- The [Total Station Toolbar](#) topic
- The [Robotic Total Station Toolbar](#) topic
- The [GNSS Toolbar](#) topic

Topo Toolbar

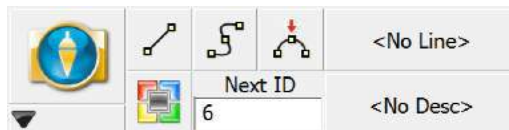

The Topo Toolbar is used to help automate linework as well as show you the description and next point number for your shot. Just like previous versions of FieldGenius you can control your linework by tuning on and off the line, arc and curvy toggles. There is also a user-programmable button that can be customized to start any command.



Main Menu Button

This button takes you into the [Main Menu](#).

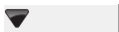

Mini Toolbar Button

This button opens the [Mini Toolbar](#).



Draw Lines Button

This is used to toggle on and off the draw lines function. When turned on points will be connected with a line as you measure them.



Draw Curvy Lines Button

This is used to toggle on and off the draw curvy lines button. This function will draw a best-fit curve through your points as you shoot them.



Draw 3-Point Arc Button

3-Point arcs can be started using the same method as for a Line or Curvy Line.

However, to switch to 3-Point arc within an ongoing Line, select the **Draw 3-Point Arc** button before shooting the second of the three points that will define the arc (POC: Point on Curve). (Note that this is not the radius point). After measuring to the 2nd point, a dashed line will appear to illustrate that a 3-Point arc is in progress. Shoot the 3rd point and the arc will appear. The current draw option will change from Draw 3-Pt Arc to Draw Line after the third shot and the arc is complete.

Compound 3-point arcs are supported. Simply re-select the **3-Point Arc** button before measuring the next POC.

User Defined Button



This button can be customized to start any command. By default it opens the [Coordinate Database](#), but this can be changed in the [Keyboard Shortcuts](#) settings.

Next ID
29

Next ID Field

This field displays the point number that will be assigned to your next shot. You can change it at any time prior to recording your shot. In a new Project this field will always start at 1. If you open an existing Project, then we scan the raw file for the last sideshot or store point and if we find one, we'll set the point number accordingly. For example, if the last sideshot in the raw file was to point 58, then the next time the Project is setup we will set the next id to 59.

<No Line>

Active Line List Button

Much like the first line in the Project, just select the desired description from the list and select the desired draw option before shooting the first point for the new line. When you press the button a screen will appear listing all your active lines. Selecting one of them and pressing the **OK** button will make it the current line.

The key to note is the display of -Start Line- in the Active Lines list. Once the first point for the new line has been measured, the Active Lines list will set and display the new line as current.

To change the current line, simply select the desired line from the Active Lines list and continue taking shots to add to the selected line. All settings are stored for each line so there is no need to re-select the Description or draw option.

<No Desc>

Description Selection Button

Use this button to set the current description that will be used when you shoot your points. When you press the description button you will see a screen listing all the descriptions read in from your [AutoMap Library](#). Select the description you want to use and press the OK button. You can type in the letters of the description which will automatically scroll to the descriptions matching your entry.

Mini Toolbar



The mini toolbar control is found directly beneath the Main Menu button on the [Topo Toolbar](#). It is used to help you maximize your screen space by allowing you to control which toolbars you need to keep active in the main interface. When you press the mini toolbar control you will see the mini toolbar appear toward the bottom of the main interface.

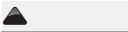

Use this to display the full [Topo Toolbar](#).

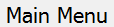

Use this to display the [Main Menu](#).



Use this show or hide the [Display Toolbar](#).

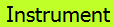

Use this to show or hide the [Instrument Toolbar](#).

Map Select Toolbar

When you tap on an empty spot in the map view, the selected point will be highlighted with a blue dot and the Map Select toolbar will appear along the bottom of the screen, showing the coordinate of the selected point.

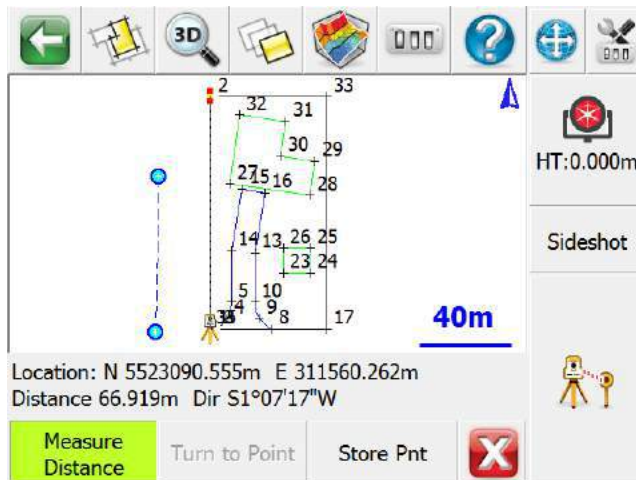

Note, this toolbar functionality can be enabled or disabled via the Map Position Select check-box in the [Options](#) screen.

Measure Distance

When this is toggled on, subsequent taps will cause the blue dot to move to the new location, a second blue dot will appear at the previous location, and a dashed line will follow the entire path of the selected points. The total distance and the direction of the last segment will be displayed. To reset the measured distance, toggle this mode off then back on again.

Turn to Point

If you are using a motorized total station and have occupied a point in the Project, this will cause your instrument to turn to the selected point (as indicated by the blue dot in the map).

Store Point

This will open the [Store Point](#) dialogue with the coordinates entered for the selected point, so you can store it into your Project database.

POINTS & FIGURES

Points

FieldGenius Projects typically are comprised of points that have been imported, calculated or measured. These points are always stored in a file made up of the Project name and will have an extension of DBF. DBF files can be viewed using a DBF reader or with Microsoft Excel.

Point Labels

In the drawing area you will always see a node or dot that marks the coordinate location of the point. For each point you can control what is displayed on the screen such as the point's number, elevation, description and note. To control the visibility of the labels, use the Options button on the [Display Toolbar](#).



Editing Single Points

To edit a point you can tap on it which will open the [Point Toolbar](#). Press the Edit button to open the [Edit Points](#) screen.

Working with Multiple Points

If you need to search, list, rotate, translate, delete, or edit multiple points at the same time you will use the Coordinate Database Editor. Please see the [Coordinate Database](#) topic for more information.

Point Toolbar



When you tap on an existing point in the drawing you will see the point toolbar appear near the bottom of your screen. The point toolbar contains functions that are frequently used on points in your Project. Following is an explanation of what each button will do.



Points List

This will display the list of all points in your current Project and you can sort the list by tapping on any of the column headings. When you find the point you want simply tap it and press the ok button.



Inverse Tool

Use this to measure the [inverse](#) between points.



New Point

This will open the [store and edit](#) dialog and allow you to enter coordinates for a new point.



Edit Point

Use this to edit the coordinate value for the selected point.



Delete Point

This will delete the selected point from the drawing and database. You will be asked to confirm that you want to delete the point.



Offset

This will open the [Offset Tool](#).



Draw Tool

Use this to draw lines, points, and connect line work between existing points. This will open the [Draw Tool](#).



Zoom to Point

This button when pressed for the first time will force the point to be centered on the screen. Subsequently, if you keep pressing it, it will continue to zoom in on the point.



Stake Point

Pressing this will help you stake the point that is currently selected and take you to the [Stake Points](#) screen.



Select Point

Use these two buttons to scroll up and down numerically through the points in your database.



Point ID

104

This displays the Point ID of the point you've currently selected.

Select Point Toolbar

The point chooser is a mechanism that is called by routines requiring a point number entry. You access it by selecting the point chooser icon next to point number fields, or by double-tapping in an extended edit point number field.



When select it you will see the point chooser toolbar open up towards the bottom of your screen.

Point ID	274	North:	5495620.045m
		East:	313940.445m
<input type="checkbox"/> Quick Select		Elev:	518.387m
		Desc:	TH
	Select		List
			New
			Cancel

Point ID

You can either type the Point ID into this field if you know what it is, or when you tap on a point in the map screen its point ID will be displayed here.

Quick Select

If Quick Select is turned on, then as soon as you tap on a point in the map screen you will be automatically returned to the routine you were selecting the point for. If Quick Select is turned off, then after you tap on a point in the map screen, the coordinate data of that point will be displayed, and you must press the Select button to get back to the previous routine.

Select

Pressing this will take you and your selected point back to the routine you were selecting the point for.

List

Use this to open a grid displaying all the points in your Project database. From this list you can click on a point and when you press the OK button it will be inserted into the Point ID field.

New

Use this to open the [Store / Edit Points](#) screen. This will enable you to create a new point.

Cancel

Pressing this will take you back to the routine you were selecting the point for, without selecting the selected Point.

Point Averaging

[Main Interface | Edit | Points](#)

[Main Interface | Store Points](#)

[Main Menu | Survey Tools | View Averaged Points](#)

[Main Menu | Data Manager | Point Database](#)

This routine allows the user to either select a number of points from within the Point Database, and then calculate the average of the coordinate values of the selected points or take repeated measurements on a target and average the coordinate values. You can then create and store a new point based on the averaged coordinates.

Below is a screen capture taken after an observation has been completed and is awaiting to be stored. Note that there is a pull down menu for the user to choose to store this measurement as an averaged point.

The screenshot shows the 'Store Point' dialog box with the following fields and options:

Point ID	12
Description	AVERAGED <input type="button" value="List"/>
Northing	114687.206m
Easting	720558.913m
Elevation	223.971m
Prism Hgt	1.300m
Store As	Averaged Point

Buttons on the right side: Review Measurement, GIS Attributes, Advanced, Enter Note.

Buttons at the bottom: Store Pnt, Cancel.

After the observation has been stored the next screen will prompt you to select the Original Point to which this point will be averaged too. If this is the first observation then the point should be stored as a Side Shot to begin the Point Averaging routine.

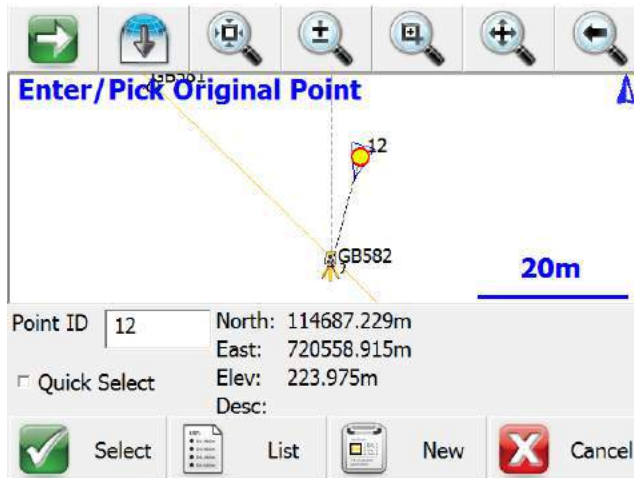

After two or more observations are stored as an Averaged Point; FieldGenius will display the Standard Deviation of all the observations included in the Point Averaging. The user can then choose to **Save** the temporary observations for future use or **Store Averaged** to update the Point coordinates with the result of the Point Averaging observations.

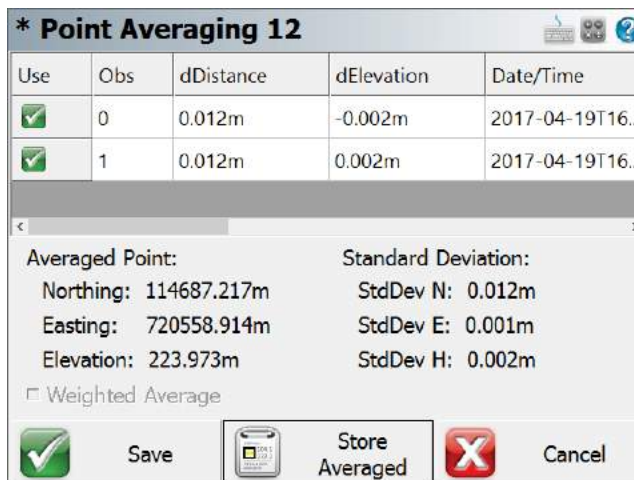

Observations can be toggled manually by pressing the Green Check Mark to select the best ones for averaging calculations.

The Weighted Average check box will only be active when using a GNSS unit

Press the "SAVE" button to store all observations in the Averaged Point routine for future use.

Press the "Store Averaged" button to calculate a point position based on all Point Averaged observations currently being used.

All the temporary shots, observations used for the calculation, and final averaged position are stored in the raw file.



Point Database

FieldGenius can also calculate the averaged coordinates of multiple stored points directly from the Point Database.

When you enter the Point Database, tap on the green arrow button twice in the bottom toolbar until you see the **Average** button displayed. **Note:** The items will loop back around to the first item if you keep pressing the green arrow button.

Select multiple points by tapping on the screen and dragging a box around the items you wish to include in the averaging calculation.



Point ID	Northing	Easting	Elevation
13	5523079.354m	311585.366m	384.494m
14	5523079.397m	311585.376m	384.511m
15	5523079.415m	311585.390m	384.502m
16	5523079.430m	311585.377m	384.578m
17	5523079.438m	311585.538m	384.201m
18	5523079.430m	311585.507m	384.186m
19	5523079.442m	311585.496m	384.210m

Buttons:  Average 

Use	Name	dDistance	dElevation	Description
<input checked="" type="checkbox"/>	13	0.046m	0.029m	
<input checked="" type="checkbox"/>	14	0.003m	0.005m	
<input checked="" type="checkbox"/>	15	0.021m	0.021m	

Averaged Point:
 Northing: 5523079.399m
 Easting: 311585.377m
 Elevation: 384.523m

Standard Deviation:
 StdDev N: 0.028m
 StdDev E: 0.009m
 StdDev H: 0.033m

Buttons:  Store Point  Cancel

In the Point Averaging dialog, the results of the averaging computation are displayed. You can uncheck the box in the **Use** column to disable/re-enable a selected point.

Press the **Average** button when finished. This takes you to the Point Averaging dialog.

The **Store Point** button takes you to the [Store Point](#) dialog.

The **Cancel** button returns you to Point Database dialog.

FieldGenius also allows the user to select the Original Point from the Point Database and by pressing the "Edit" button there is a new button in the Edit Point screen that displays all the current Point Averaging observations assigned to the Original Point. So you can continue to add shots to it or if satisfied store a new averaged point location.

Partition Lines/Arcs

[Line Toolbar](#) | [Partition button](#)



The Partition command is started by selecting a valid line or arc in the map screen, which will open the [Line Toolbar](#) where you can select the partition button. After you select the partition button you will see the partition toolbar.

The partition line and arc command allows you to compute points along objects in your Project. You can partition figures that have line and arc segments that have a radius point defined. 3 point arcs cannot be partitioned. Straight lines in DXF files can be partitioned, all other DXF entities are not compatible with the partition command.

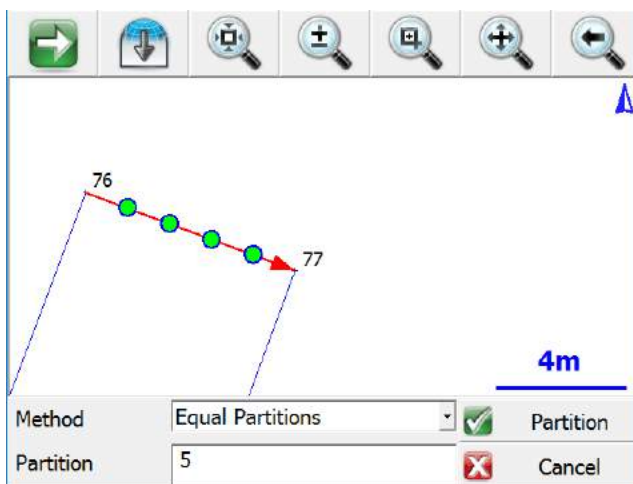

Equal Partitions

You can partition the segment by equal divisions. Simply select the partition number and press the Partition button. This will compute new points and split the object up into separate segments.

By Distance

You can partition the segment by specifying a distance between partitions. Simply define the partition distance, then press the Partition button. This will compute new points and split the object up into separate segments.

AutoMap Library

[Main Menu](#) | [Settings](#) | [AutoMap Library](#)

The AutoMap Library editor allows the user complete control over the visibility of points and lines based on the descriptions used to code the points. It also allows you to set attributes for the descriptions such as point and line colour.

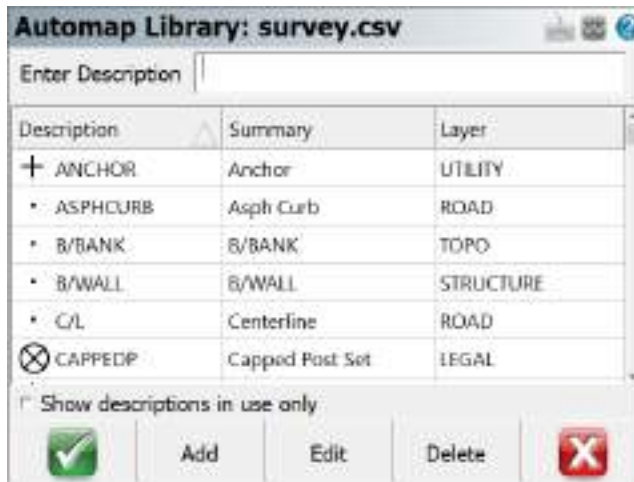

Enter Description

Use this field to auto scroll to description in your list. For example, typing the letters AS will scroll down to the ASPHCURB description. If you type a unique description and press enter, you will be prompted for whether you want to add it into the AutoMap Library or not.

Show descriptions in use only

Use this to display only the descriptions found in your AutoMap Library that are used in the current Project.

Adding Descriptions to the Library in FieldGenius

While you're working you can add descriptions to the AutoMap Library on the fly. When you enter a description that isn't in the library you will be prompted with a message asking you if you want to add it to your Project's AutoMap Library file.

Note: This prompt can be turned off so FieldGenius always uses the new descriptions without adding them into the AutoMap Library file. To do this you need to make sure you have the **"Prompt New Descriptions"** toggle turned off in the [Options](#) menu.

If you answer **Yes**, then the description will be added into the Project's AutoMap Library file (not to the AutoMap Template file).

If you answer **No**, then the description will be used without adding it into the AutoMap Library. If you do not add it to the AutoMap Library, then you will not be able to set options such as defining the layer and colour of points and lines with this description.

Editing Descriptions in the Library in FieldGenius

The AutoMap Library editor allows you to edit properties for each description in the library. Pressing the Edit button will bring up the menu shown below for the selected entry:

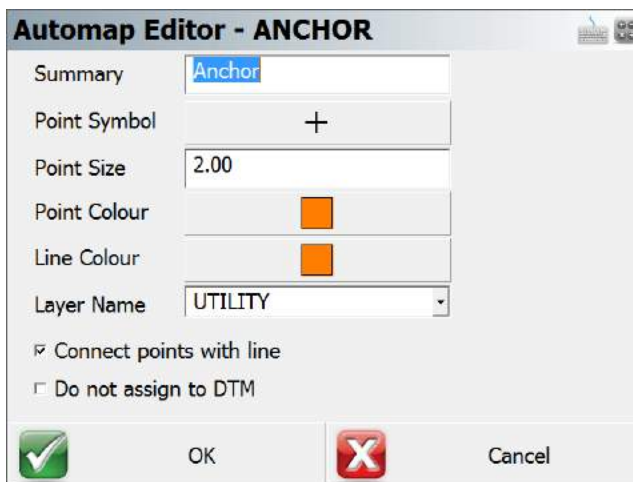

Automap Editor - ANCHOR

Summary: Anchor

Point Symbol: +

Point Size: 2.00

Point Colour: [Orange Swatch]

Line Colour: [Orange Swatch]

Layer Name: UTILITY

Connect points with line

Do not assign to DTM

OK Cancel

These properties are stored in the library in specific columns. Please refer to the topic below about editing the library for more information.

Summary

You can use this field to summarize your description. For example, a description IP may have a summary Iron Pin.

Point Symbol

You can define a marker for a point. These markers are not automatically transferred back to the desktop and are not similar to CAD blocks or parts. They are simply point nodes that will be displayed in the map view to help distinguish different points on the screen. There are 27 different marker types. The symbol for each description is also shown on the AutoMap Library screen.

Point Size

This allows you to change the size of the marker. You will find that using a number of 1 is a good starting point. Adjust from there as needed.

Point Colour

This allows you to set the colour of the markers. You can choose from a list of 255 colours.

Line Colour

This allows you to change the colour of lines in your drawing.

Layer Name

This specifies the layer that will be used for lines and points with this description.

Connect Points With Line

If this is checked, when you select the description from the topo toolbar on the main display, the connect lines toggle will be turned on automatically. Use this for descriptions that typically are connected by lines such as an edge of road or ditch center line.

Do not assign to DTM

This is very useful for the creation of real-time surface models. If you toggle this ON, then these points will not be included in any DTM created with FieldGenius. Use this for descriptions that are not at ground level.

Deleting Descriptions from the Library from FieldGenius

The AutoMap Editor allows you to delete descriptions from the library. Pressing the Delete button will prompt you to make sure that you want to delete the selected entry. This will delete that entry from the Project's AutoMap Library file, it does not affect the AutoMap Template file.

Editing an Existing Library outside of FieldGenius

The AutoMap Library is a very powerful feature in FieldGenius. When combined with our desktop products, your downloaded files can literally be imported, layers and symbols placed in seconds. For this topic we will concentrate on helping you work with and edit the AutoMap library using FieldGenius.

The FieldGenius AutoMap library is a comma delimited file that can be edited with MicroSurvey CAD or inCAD, with a text editor like Microsoft Notepad, or with a spreadsheet application like Microsoft Excel. Since not every FieldGenius user owns our desktop software we will discuss editing the file with Excel.

The first row in the file is reserved for the column header. Some of the columns are reserved for our desktop products, but the following columns are used in FieldGenius.

Column A = Description (String value)

Column B = Summary of Description (String value)

Column L = Connect Points with Line (1=Yes, 0=No)

Column M = Layer Name (String value)

Column O = Line Colour (Number 0-255)

Column Q = Line or Spline (0=Spline, 1=Line) *** This works in conjunction with Column L.

Column U = Marker Type (Number 0-26)

Column V = Marker Size (Number 0-10)

Column W = Marker Colour (Number 0-255)

Column X = Exclude from DTM (1=Yes/Exclude, 0=No/Include)

Column AF = Zone Number (Numeric Value)

Create New Library outside of FieldGenius

You can easily start a new library from scratch simply by creating a simple text file. In the first row add a header followed by your descriptions and summaries. You have to separate the values with a command and when you're done save the file with an extension of .CSV - an example filename might be CODES.CSV.

```
DESCRIPTION, SUMMARY
PIN, Iron Pin,
EC, Edge of Concrete,
EP, Edge of Pavement,
```

You can then copy the file to your ...**MicroSurveyFieldGeniusFG Projects**\ (Windows CE/Mobile) or ...**DocumentsMicroSurveyFieldGeniusFG Projects**\ (Windows Tablet/PC) directory. When you create a new Project or open an existing one, make sure to select it as the AutoMap Template File.

Feature List

A feature list is a tool built into FieldGenius so you can collect attribute data for your points. Feature files allow you to define what data needs to be collected about a point's attributes. You can define mandatory fields, default values, true/false items and select from list options. First you need to create a feature list file using the Feature List Editor which can be installed from your FieldGenius CD. Please refer to the help menu in the editor for more information on how to create an effective feature file.

Feature files have a **FEA** extension and they should be copied to your ...**Mi-croSurveyFieldGeniusFG Projects**\ (Windows CE/Mobile) or ...**Docu-mentsMicroSurveyFieldGeniusFG Projects**\ (Windows Tablet/PC) directory. There is no limitation to the number of feature files that can be stored on your data collector. Once you have created your file and copied it to the appropriate directory, you can set it at the [Review Files Screen](#).

In this example we will open a Feature List File named Sample.fea.

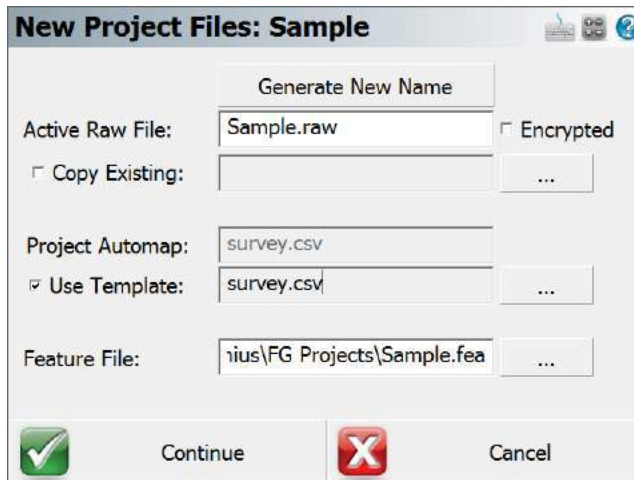

To collect attribute data for a point, you have to press the **GIS Attributes** button on the store and edit dialog.

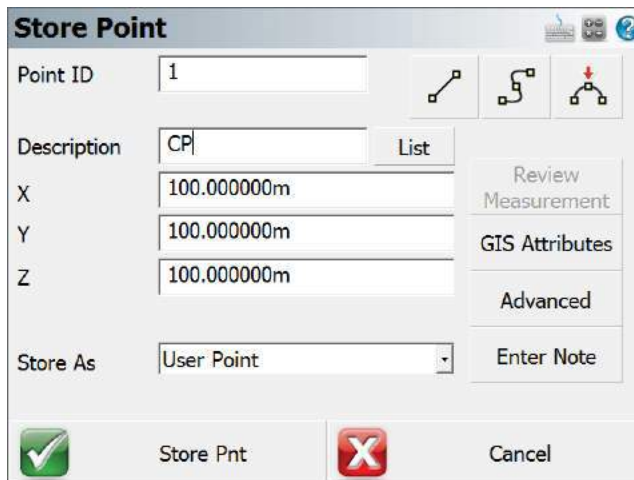

When you store a point during a measurement or edit one afterwards, you will see that you can select the **GIS Attributes** button. When you press this button, it will look at the point's description and check to see if you have a feature defined that matches. If it does, it will open up that feature for you automatically, in our example you will see that the Power Pole feature was opened.

Point 1	
Feature	Power Pole
Serial Number	12345
Material	Wood
Height (m)	15
Transformers	None
Lamp Attached	<input type="checkbox"/>
Condition	Good
OK Cancel	

As you can see, feature files help you collect consistent and accurate notes about a point you measured.

When you store the point, a file will be created in the Project directory. The file will have the same name as the feature and will have a DBF extension. In our example, the file would be named POWER POLE.DBF. Each point will be appended to the same database file.

The DBF database file can be opened with Microsoft Excel.

Notes

Use this to enter or record audio notes for your points. You can access the notes screen by pressing the **Notes** button on the [Store / Edit Points](#) screen.

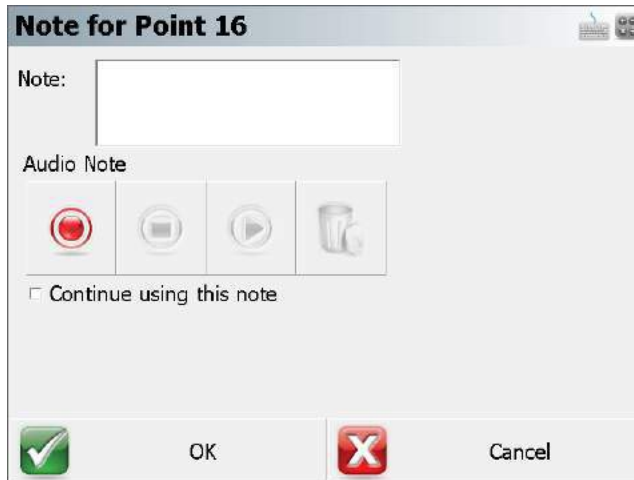

Text Notes

You can type a note up to 32 characters in length and it will be stored in the Project's DBF file. You cannot enter more than this limit into the Note field.

When the file is imported into MicroSurvey CAD or inCAD, the note will appear in its own field, or can be appended to the point's description field.

Continue using this note: Use this if you want to use the note you just entered automatically for future points that are stored.

Text notes can be written to the raw file as comments when the [Option](#) is enabled.

Audio Notes

Use this function to record and playback audio notes that are related to stored points. These notes will be transferred to MicroSurvey CAD or inCAD desktop software for playback in the office.

The notes will be stored in your Project directory and will be automatically named for you. Example, if you recorded a note for point 2, a file would be created pnt2.wav. The file that is created is a standard windows WAV file that can be played by most audio players.

MicroSurvey CAD or inCAD desktop software will automatically link to any audio note you recorded. This allows you to easily see which points have audio notes.

Recording and Playback Controls

Circle = record

Square = stop

Triangle = playback

Trash = delete

Note that not all handheld devices support audio notes. You must have a record and playback functionality, which for some units requires optional accessories.

To Store an Audio Note:

1. Tap the red circle to activate recording. Speak into your microphone to record the desired information. "This post is bent" etc.
2. Press the square button to stop the recording
3. To confirm your note, press the playback arrow, now green on color displays, and listen to your note

To replace an Audio Note with a new note:

1. Delete the existing audio note. You will be prompted to confirm the deletion.
2. Record a new audio note.

Photo Notes (Not available on all devices)

Use this function to record photo notes for a point. **This option is only available on data collectors that have a Camera.**

Camera

The Camera button is used to take a picture. When you press it, it will start the onboard camera software and allow you to snap a picture. The picture will be saved in the current Project folder with the filename **[point number].jpg**. The image quality and settings will be determined by the camera setup for the device. If the Camera button is greyed out, it means that a photo note already exists for this point, and you must delete it first if you would like to replace it. The photos will be automatically imported into your MicroSurvey CAD or inCAD desktop software for viewing in the office.

Delete Picture

The Delete Picture button will delete the photo stored for the point.

Lines and Figures

Active Linework

FieldGenius has Code-Free linework control in the field to eliminate the need to remember line codes. To activate linework on the fly while surveying, you simply choose the description you want and start taking shots! For MicroSurvey CAD or inCAD desktop users, line connectivity codes setup in the desktop AutoMap library will be used by FieldGenius. For more information see the [Draw Option Defaults](#) section.

FieldGenius uses the concept of Figures for handling of linework. Some software packages refer to these as "Chains".

At the bottom of the FieldGenius interface, you will see the Active Lines List button on the second row. When a new Project is started, it will display [**-No Line-**] as the current, active line.

When a new line figure is about to be started, [**-Start line-**] will be displayed on the button. After the first point for a new line has been measured, the active line will be created, made current and displayed.

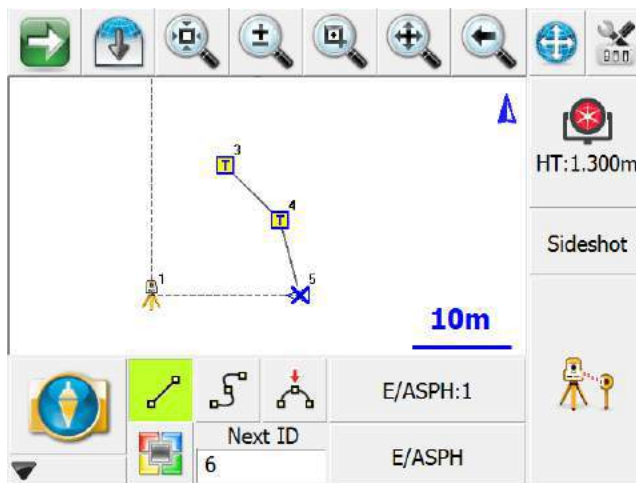

In the example shown, notice E/ASPH:1 on the button. This is the current Active Line. E/ASPH is the point description and 1 is the group number (added automatically). Since this is the first figure in the map, it is assigned group 1.

A Figure is a continuous series of Line, Curve and/or Arc segments. The Figure is identified by Point Description and a group number. Whenever a new line is started, a new Figure is created and added to the Active Lines list with an automatically assigned group number. The group number will increment by one when a previously used point description is used for a subsequent line. (Notice there are two E/ASPH lines in the example)

Furthermore, all linework in FieldGenius is handled in 3D.

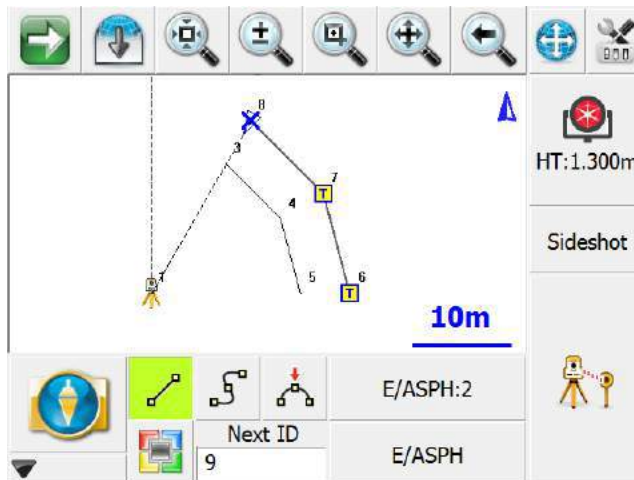

When you press the E/ASPH:2 Active Line button you will see a list of the figures in your Project.

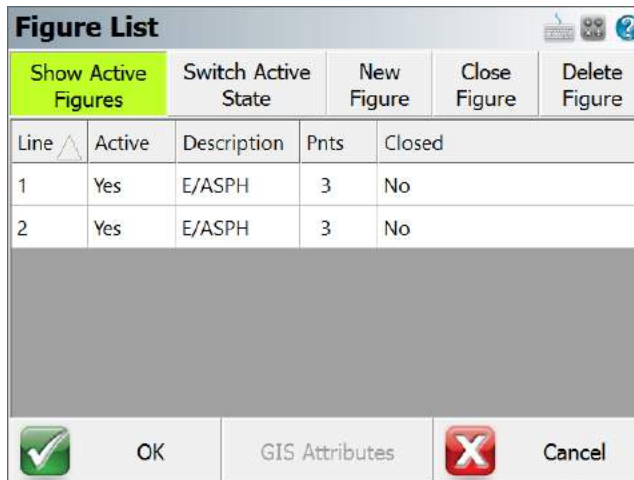

Figures

Tangents, arcs and curvy lines in FieldGenius are also called figures. Figures are created automatically for you as soon as you connect points in the drawing.

Figures can be created while you survey in real-time using our active linework or you can manually create the figure using the pencil tool.

FieldGenius Figures

When you click on a figure the [Line Toolbar](#) will appear. You will also see bold text in the drawing area indicating what you selected.

DXF Linework

When you import a DXF drawing you will see all the linework that exists in the drawing. When you select a DXF line or arc you will see the [Line Toolbar](#) but everything will be greyed out except for the stake and perpendicular distance buttons. If you press the stake button or perpendicular offset to point button, they will open up their respective toolbars.

When you click on a DXF entity you will see bold text in the drawing area indicating that you picked a DXF line or arc, and it will display which layer it is on.

You can control the visibility of DXF layers through the [Layers Manager](#) screen.

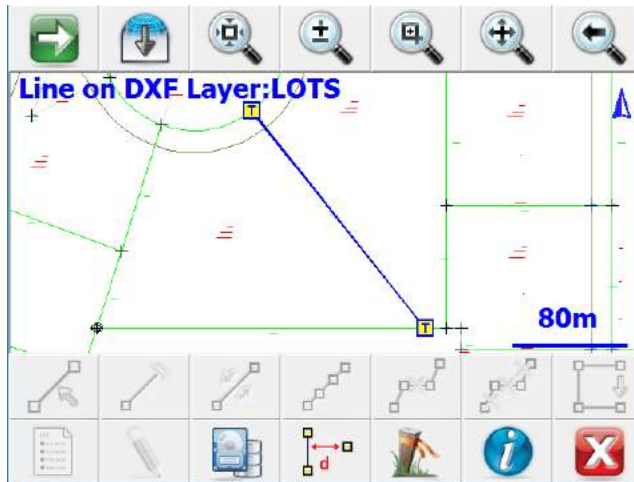

Coordinate DXF Data

You can add coordinates to the DXF entity by pressing the Coordinate DXF Data button.



Information

You will see the inverse information based on the DXF entity you picked by pressing the Information button

Line Toolbar



When you tap on an existing line or arc you will see the line toolbar appear near the bottom of your screen. The line toolbar contains functions that are frequently used on line or arcs in your Project. Following is an explanation of what each button will do.



Set Figure Current

Use this to make the current line or arc current in the Active Line List.



End Figure

Use this to mark a line as complete or finished.



Reverse Figure Direction

Use this to switch the direction of a figure so you can append to the opposite end.



Partition Line / Arc

You can [partition \(split\)](#) a figure or DXF line into smaller segments using this command.



Delete Figure Segment

Use this to delete a segment from a figure.



Delete Entire Figure

Use the delete an entire figure.



Close Figure

Use this to close a figure so it finishes at the same point it started at.



Open Figure List

Use this to display the Active Line List.



Draw Tool

Use this to draw lines, points, and connect line work between existing points. This will open the [Draw Tool](#).



Convert Line to Spline

This will turn an existing figure that is comprised of straight lines into a curvy line, and vice-versa.



Offset Tool

Use this to open the [Offset Tool](#).



Stake Figure

Use this to open the stake line command and stake the current line you have selected.



Coordinate DXF Data

You can add coordinates to the DXF entity by pressing the Coordinate DXF Data button.



Information

This will display the inverse information of the segment you have selected, as well as the perimeter and area if it is part of a closed figure.

Select Line Toolbar

Various commands will use this toolbar to help you select a line.

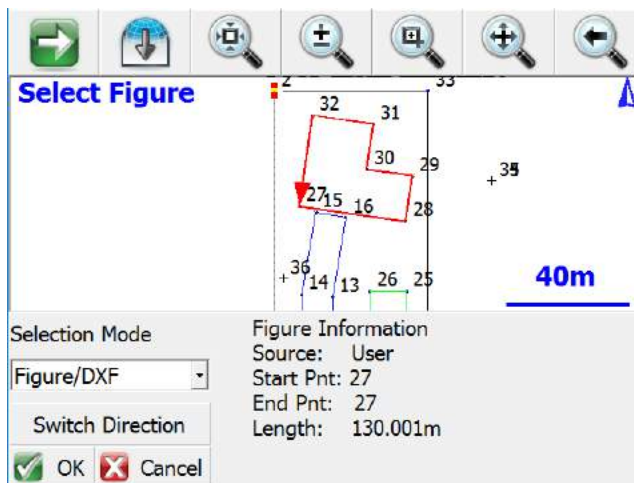

Whichever Selection Mode you use, the selected line will be highlighted in red in the map screen along with a direction indicator. If necessary, you can press the **Switch Direction** button to reverse the start and end of the selected line. Press OK to accept the selected line and proceed to the next step.

Selection Mode: Figure/DXF

Pick this mode to select an existing figure or DXF entity by selecting the desired figure from the map screen. You can select any of the following:

- Figures containing lines and/or arcs (but not curvy splines)
- DXF lines, arcs, and/or polylines (but not splines, splined polylines, or fitted polylines)

Selection Mode: Figure Segment

Pick this mode to select an individual line or arc segment from a complex figure, by selecting the desired segment from the map screen. You can select any of the following:

- A line or arc segment from a Figure (but not a curvy segment)

Please Note: A line or arc segment from a DXF polyline cannot be selected.

Selection Mode: Define Points

Pick this mode to select points in your Project to define a line or arc. You can define the following line types:

- Straight Line: select a Start Point and End Point
- Arc (CW): select a Start of Curve Point, Radial Point, and End of Curve Point
- Arc (CCW): select a Start of Curve Point, Radial Point, and End of Curve Point
- Arc (3Pnt): select a Start of Curve Point, Point on Curve, and End of Curve Point.

Switch Direction

The line direction will reverse, and the arrowhead shown in the map screen will show the current "forward" direction of the line.

OK

The highlighted line will be selected, and you will be returned to the appropriate command.

Cancel

You will return to the previous screen without selecting anything.

Figure List

The figure list contains a listing of all figures in your Project.

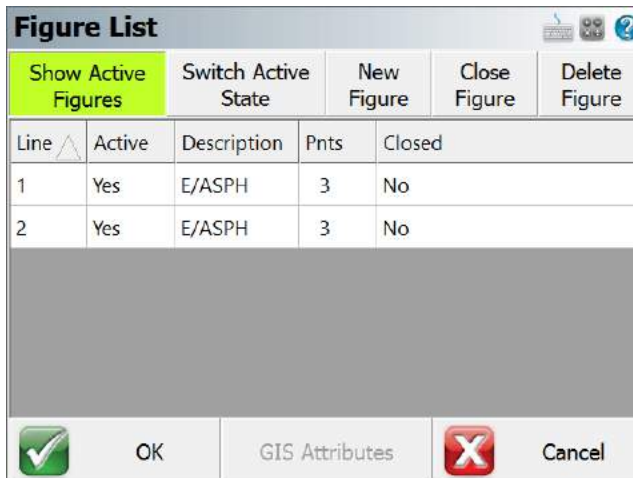

Line Column

This is the group id assigned to the figure. Refer to the [Active Linework](#) topic for more information.

Active Column

If the figure is active, you will see the word **YES**. To make a figure not active, press the Switch Active State button.

Description Column

This is the name of your figure which will usually match the description of the first point that the figure is connected to.

Points Column

This is the total number of points that the figure is connected to.

Closed Column

If you [closed the figure](#) you will see the word **Yes**.

Show Active Figures

When this is selected (default setting) all of your active figures will be listed. You can select a figure that you would like to work on simply by selecting it in the list and pressing the OK button. If this is turned off, then all the figures in the Project will be displayed.

Switch Active State

Use this to change the status of a figure to "finished". When this is done, it will no longer be displayed in the figure list of the Show Active Figures button is on. Once a figure is switched to a not active state, nothing can be added to it.

Figures that are not active, can be made active again simply by selecting the figure you want to use and pressing the Switch State button.

New Figure

Use this to create a [new figure](#) in the figure list.

Close Figure

Use this to [close a figure](#) so it will close back to the starting point.

Delete Figure

Use this to delete a figure that you have highlighted in the list. You can delete figures that are flagged as active, or not active. Review the [delete figures](#) topic for more info on deleting.

Using Active Figures

Active Linework Options

We have 3 Draw Options for Active Linework, selected from buttons that appear beside the Description and Active Lines drop down lists:



Draw Lines button = Connect points with straight lines



Draw Curvy Lines button = Connect Points with a best-fit curvy line.



Draw 3-Point Arc button = Fit an arc through three measured points

Start the first Line in a Project

To start the first line in a new Project, choose the desired point Description from the Description List and select the desired draw option before you start taking measurements. The Active Lines list will display -Start Line- as shown. At this point, the next point measured will be the first point of a new Active Line using the E/ASPH Description. Use the measure button to measure the starting point for the new line.

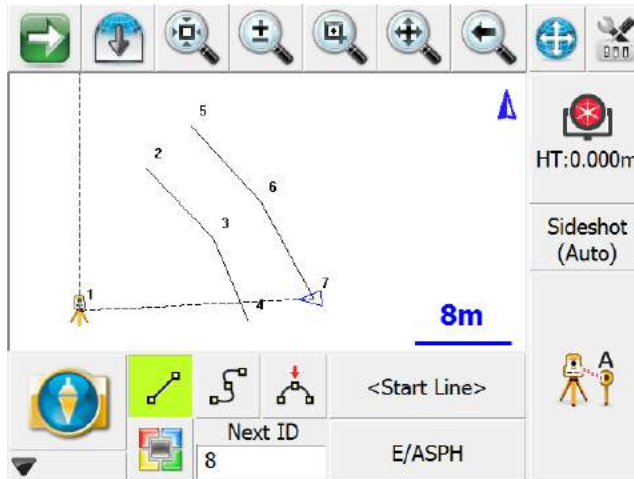

After the measurement to the first point for the new line is complete, the line will be added to the Active Lines list, identified by the current point description and an automatically assigned group number: E/ASPH:3. The group number is three, because this is the third figure using the description E/ASPH.

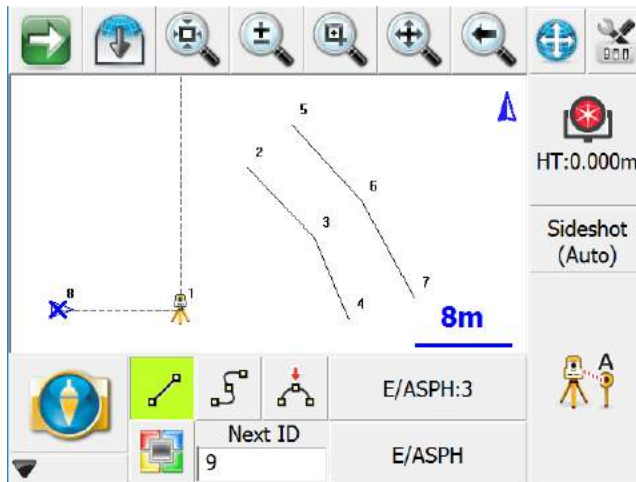

After the second point for this line has been recorded, the first segment will be created. From this point forward, simply continue taking shots to add to the now current Active Line: E/ASPH:3

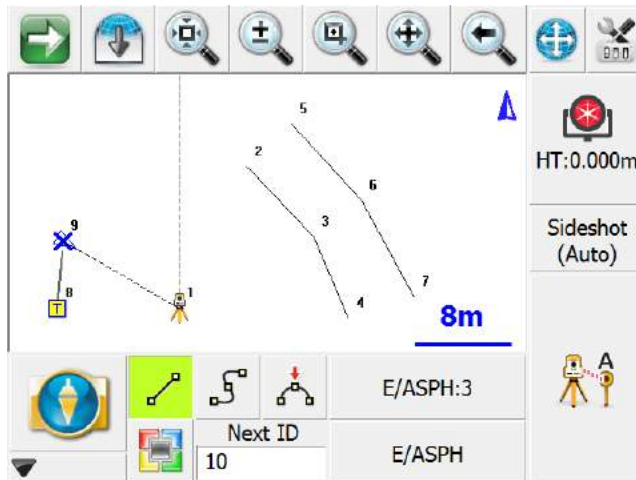

Note the insertion of ":3", this is the group number. Re-use of the Description E/ASPH for a new line series in the current Project will automatically increment the group number by one. This allows you track and store multiple active lines of the same description without the need for multiple entries in your AutoMap Library. For example, E/ASPH:2, E/ASPH:3 ... E/ASPH:n can now be replaced with a single E/ASPH entry.

Stop adding to a Line

If you wish to stop adding to the current line, simply deselect the current draw option (Line, Curvy line) before taking any more shots. After turning off the draw option, -No line- will display in the Active Lines list button.

Start a subsequent New Line

Much like the first line in the Project, just select the desired description from the list and select the desired draw option before shooting the first point for the new line.

The key to note is the display of -Start Line- in the Active Lines list. Once the first point for the new line has been measured, the Active Lines list will set and display the new line as current.

Change Description within an Active Line

You may change the description within one ongoing line. Simply choose a different description and continue taking shots. The ID of the Active Line will not change.

Figure Direction Marker

The current line in the map is always defined by a bold outline and a blue X at the end of the line. The blue X indicates the line direction so you know what end of the line the next measurement will be connected to.

You can see that the blue X is on point 29. After you take your next shot, it will be automatically connected to this point.

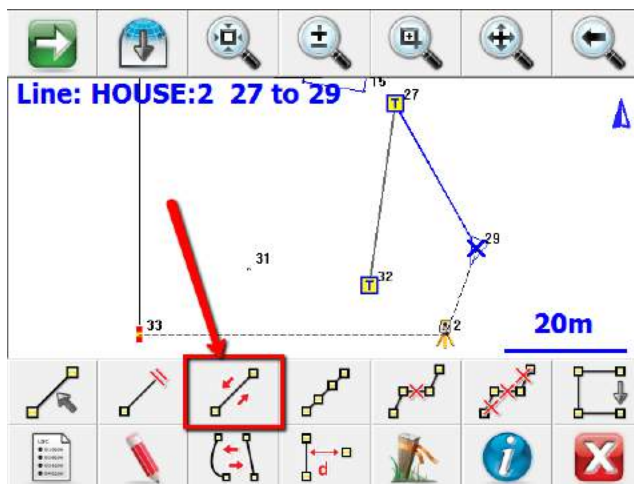



Once you select the figure, you will see the line toolbar. On this toolbar, select this button to reverse the direction. After you switch the direction, you will see the blue "X" move to the opposite end of the figure.

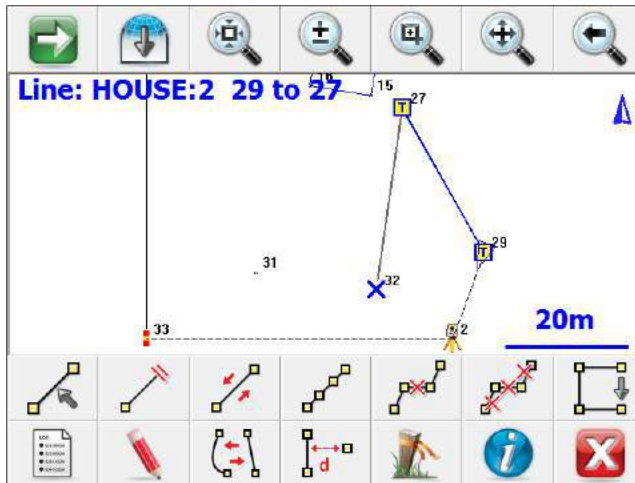

New Figure

Pre-selection of Line Descriptions

A list of Active Lines (Figures) may be pre-specified to aid in planning for a complicated Project. Use the **New Figure** button on the Active Line List screen to specify a Line Description before taking any shots.

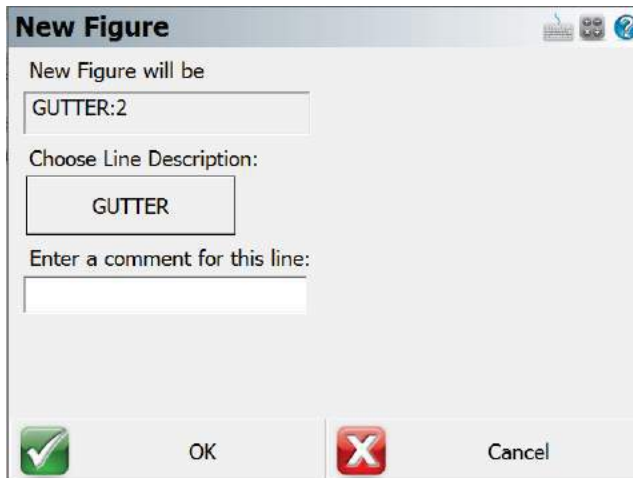

You have the opportunity to use a manually entered comment with this method but the new line will be linked to the selected Line Description. The comment will appear in the Active Lines list to aid correct selection of the line.

Switching Active Figures

You may work on several figures at once. As described, ongoing figures are listed in the [Figure List](#). You will notice that in this Project there are three figures.

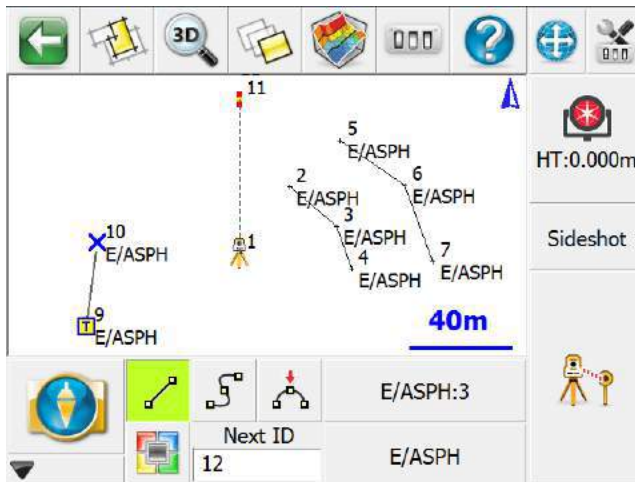

To change the current line, simply select the active line button which will open the Select Figure from List screen. In this example it is the E/ASPH:3 button.

Figure List				
Line	Active	Description	Pnts	Closed
1	Yes	E/ASPH	3	No
2	Yes	E/ASPH	3	No
3	Yes	E/ASPH	2	No

<input checked="" type="checkbox"/>	OK	GIS Attributes	<input checked="" type="checkbox"/>	Cancel
-------------------------------------	----	----------------	-------------------------------------	--------

Select the desired figure from the list and continue taking shots to add to the selected line. All settings are stored for each line so there is no need to reselect the Description or draw option.

3-Point Arcs

To draw a three point arc on an ongoing Line, select the Draw 3-Point Arc button before shooting the second of the three points that will define the arc (POC). (Note that this is not the radius point). After measuring to the 2nd point, a dashed line will appear to illustrate that a 3-Point arc is in progress. Shoot the 3rd point and the arc will appear. The current draw option will change from Draw 3-Pt Arc to Draw Line after the third observation and the arc is complete.



We are going to connect a three point arc to the E/ASPH figure. Since we are measuring the midpoint of the arc, you need to turn on the three point arc toggle.

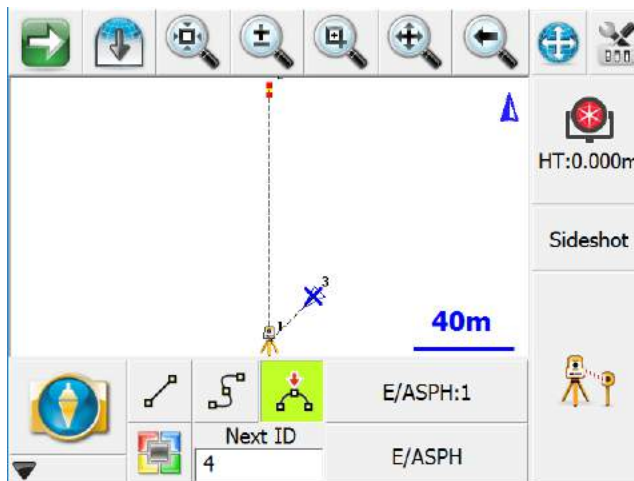

After you complete the measurement, you will see the midpoint drawn on the screen.

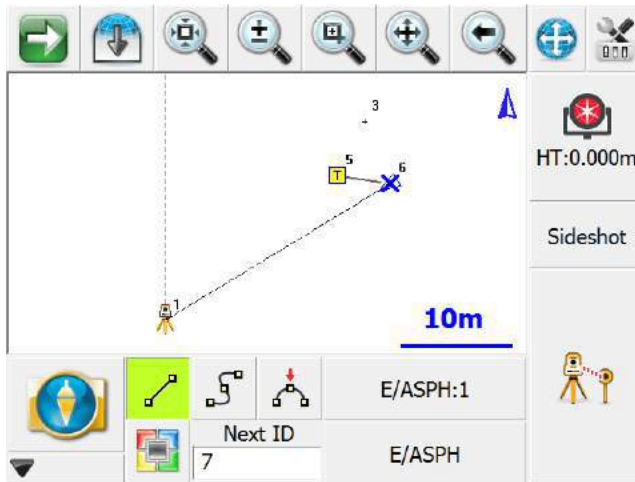

Once you complete the third measurement, you will see the arc drawn in the map.

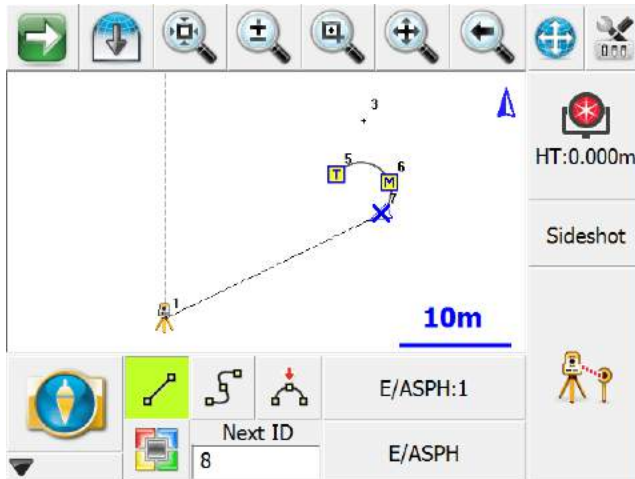

Tip: Multiple three point arcs can be connected in series if needed.

Splines (Curvy) Figures

Figures can contain splines. Splines are "best fit arcs" that are forced to go through the points that define the figure.

Splines can be attached to straight or three point arc segments.

To draw a spline, simply choose the spline toggle.

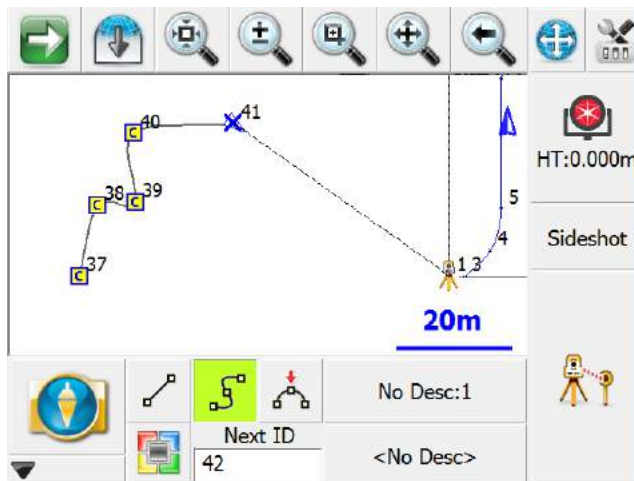

Changing Active Lines to Curvy Lines



Any Active Line series (figure) can be changed from a series of straight segments to a best-fit curvy line. Select the figure in the drawing to open the [line toolbar](#). On the toolbar press the **Line-Spline** button which will convert the line to a curvy line. If the line is already a curvy line, it will convert it to straight tangents between the points.

Note that any 3 point arcs or straight line segments will be lost when you use this function.

Complex Figure

Figures that contain straight segments, arcs and spline segments are said to be a complex figure.

Closing Figures



To make a closed figure with an Active Line, select the **Close Current Line** button on the line toolbar. This will draw a line from the last point to the first point shot in the figure. The Line will be removed from the Active Lines list as it is now considered complete.

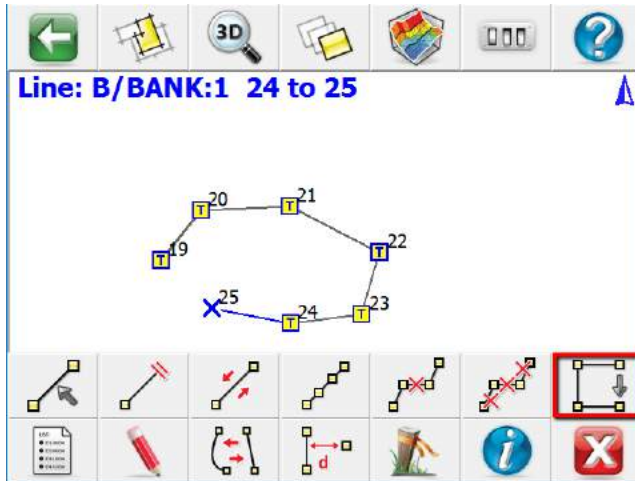

You will see that the figure now is closed back to the original start point.

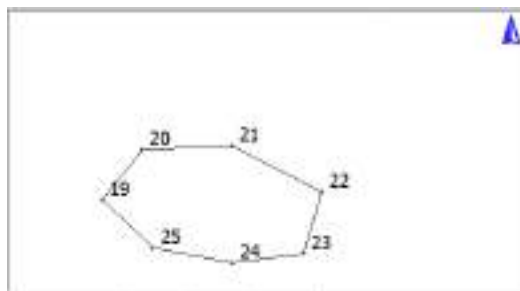

In the active lines list, if you turn off the **Show Active Figures** you will see that the figure is flagged as Active = NO and Closed = YES.

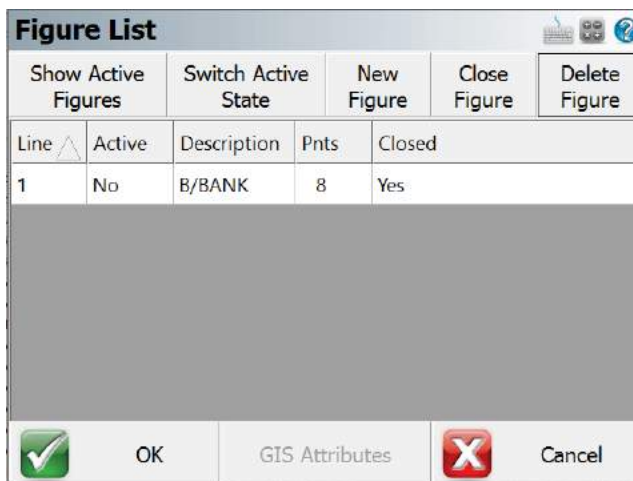

Alternatively, you can also close a figure in the [Figure List](#) screen by using the **Close Figure** button.

End (complete) a Figure



To mark a line as complete or finished, use the End Current Line button on the line toolbar. This will remove the line from the Active Lines list so that no more segments or arcs can be added.

This works similar to [closing a figure](#), but differs in that the figure will not be forced to close back on to the original start point.

Re-Activating Figures

When a figure has been marked as complete, you can activate it again as follows:

From the Line Toolbar



You can visually pick on the map view the figure that you would like to re-activate. On the line toolbar, select the activate button which will make the selected figure active.

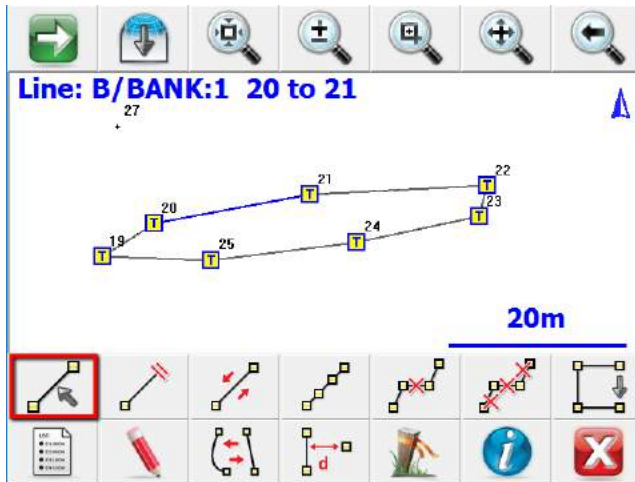

From the Figure List

You can also open the active lines list and if you turn off the **Show Active Figures** button you will see the figures that are marked as not active. Simply select the figure you want and press the **Switch Active State** button which will set it to active.

Figure List				
Show Active Figures	Switch Active State	New Figure	Close Figure	Delete Figure
Line	Active	Description	Pnts	Closed
1	Yes	E/ASPH	3	No
2	Yes	E/ASPH	3	No
3	Yes	E/ASPH	2	No

At the bottom of the window, there are three buttons: a green checkmark icon labeled 'OK', a button labeled 'GIS Attributes', and a red 'X' icon labeled 'Cancel'.

Deleting Figures

To delete linework in your Project simply select the figure you want to delete. When you select the figure, the [line toolbar](#) will open.



Use this button on the line toolbar to delete an individual segment between two points or a three point arc.



Use this to delete the entire figure that you have selected.

Notes:

Splines: Spline sections are considered to be one entity so using the delete entire figure, or delete segment, each will do the same thing. The entire spline will be deleted.

If a segment or arc is deleted from the middle of a figure, the figure will be broken into two pieces. Each new figure will be assigned a new group number. Closed or ended figures will be re-activated and added to the Active Lines list.

You can also delete a figure by selecting it in the [active lines list](#), then pressing the Delete Figure button.

Figure List				
Show Active Figures	Switch Active State	New Figure	Close Figure	Delete Figure
Line	Active	Description	Pnts	Closed
1	Yes	E/ASPH	3	No
2	Yes	E/ASPH	3	No
3	Yes	E/ASPH	2	No

OK
GIS Attributes
 Cancel

Draw Option Defaults

To setup draw option defaults you need to own a copy of MicroSurvey CAD or inCAD. From within MicroSurvey CAD or inCAD you can use the AutoMap editor to set default draw settings for each Description in the MicroSurvey CAD or inCAD AutoMap Library. When this library is copied to your collector, selecting a Description will choose the correct FieldGenius Draw option for Active Linework in FieldGenius.

Lines

Choose the following in your desktop AutoMap library editor to set the draw default for FieldGenius to Lines.

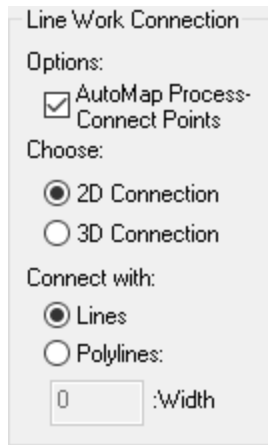

In FieldGenius when the description is selected, the line toggle will be automatically turned on.

As shown below, the line toggle has been automatically turned on when the E/ASPH description was selected from the list.



Curvy Lines

Choose the following to set the draw default for FieldGenius to Curvy Lines

Line Work Connection

Options:

AutoMap Process-Connect Points

Choose:

2D Connection

3D Connection

Connect with:

Lines

Polylines:

:Width

In FieldGenius when the description is selected, the curvy toggle will be automatically turned on. As shown below, the curvy toggle has been automatically turned on when the E/ASPH description was selected from the list.

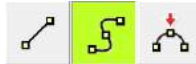

None

Choose the following to set the draw default for FieldGenius to None

Line Work Connection

Options:

AutoMap Process-Connect Points

Choose:

2D Connection

3D Connection

Connect with:

Lines

Polylines:

:Width

As shown below, when the HUB description was selected, all line connectivity toggles are turned off.

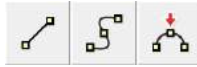

Notes:

The 2D Connection and 3D Connection settings do not affect FieldGenius, we only make use of these settings as defaults in MicroSurvey CAD or inCAD. All FieldGenius figures are 3D. With FieldGenius data imported to MicroSurvey CAD or inCAD, there is no need to process AutoMap connections as FieldGenius figures are drawn automatically. For more details on the AutoMap Library, see your MicroSurvey CAD or inCAD Help System.

Drawing Tool

[Main Menu](#) | [Survey Tools](#) | [Drawing Tool](#)

[Line Toolbar](#) | [Pencil button](#)

[Point Toolbar](#) | [Pencil button](#)

This tool allows you to quickly draw a plan such as a pad or a building footprint into your Project, and is typically used to recreate plans from a paper hard-copy. You can use this to either calculate new points, or to connect existing points that are already in your Project.

You must have at least one point in your Project before you can start, to define the starting position for your plan. If a point does not yet exist (for example if this is the first command you run in a new Project), you will be prompted to store a new point before you can proceed.

Line Mode

Use the Line draw mode to add straight line segments to your figure.

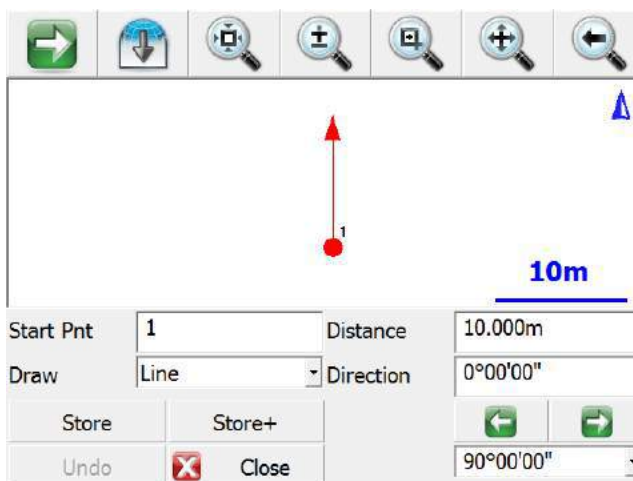

Start Point

Specify the start point for the new segment.

For starting a new plan, this should be set to an existing point in your Project, typically a corner that you will begin drawing the plan from.

As you continue adding subsequent points/segments to your plan, you will see the Start Point field automatically advance for you.

Distance

Specify the length of the line segment you wish to draw.

Direction

Specify the direction (Azimuth or Bearing) of the line segment you wish to draw. The easiest way to do this is to use the right/left arrow buttons, which will increment/decrement the direction value by the amount shown in the pulldown list below the arrows. You can select a common angle from the choices in the list (90, 45, or 30 degrees), or you can type any value if you need to increment it by some other amount.

Store

After you have defined the segment to add, press this to store the new point and line segment into your Project.

Store+

This does the same as the Store button, but you will see the [Store/Edit Point](#) screen. Use this to confirm or view the coordinates, or to specify a description.

Point by Line Mode

This is the same as the Line mode, except that when you press Store or Store+ it will only store the point, without drawing the line segment.

Arc Mode

Use the Arc draw mode to add arc segments to your figure.

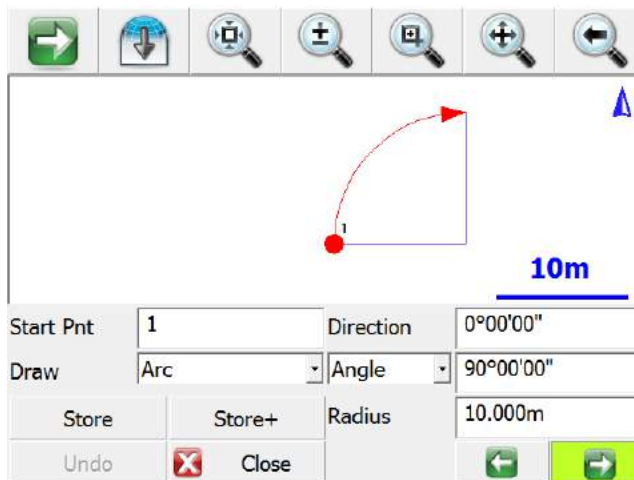

Start Point

Specify the start point for the new segment.

For starting a new plan, this should be set to an existing point in your Project, typically a corner that you will begin drawing the plan from.

As you continue adding subsequent points/segments to your plan, you will see the Start Point field automatically advance for you.

Direction

Specify the direction (Azimuth or Bearing) of the **tangent in** to the arc segment you wish to draw. This will default to either the direction of the previous line segment or the tangent out of the previous arc segment, so as long as your arc is tangential to the previous segment you will not need to change this value.

Angle / Chord Length / Arc Length

Specify one of the three available methods to define your arc:

- Angle: Enter the interior delta angle of the arc.
- Chord: Enter the chord length of the arc.
- Arc: Enter the arc length of the arc.

Radius

Specify the radius to define your arc.

Clockwise / Counter-Clockwise Arrows

Use the Right/Left arrow buttons to define whether the arc rotates clockwise or counter-clockwise.

Store

After you have defined the segment to add, press this to store the new end and radial points, and draw the arc segment into your Project.

Store+

This does the same as the Store button, but you will see the [Store/Edit Point](#) screen. Use this to confirm or view the coordinates, or to specify a description.

Point by Arc Mode

This is the same as the Arc mode, except that when you press Store or Store+ it will only store the points, without drawing the arc segment.

Connect Points Mode

This mode lets you draw lines/arcs by connecting points that already exist in your Project.

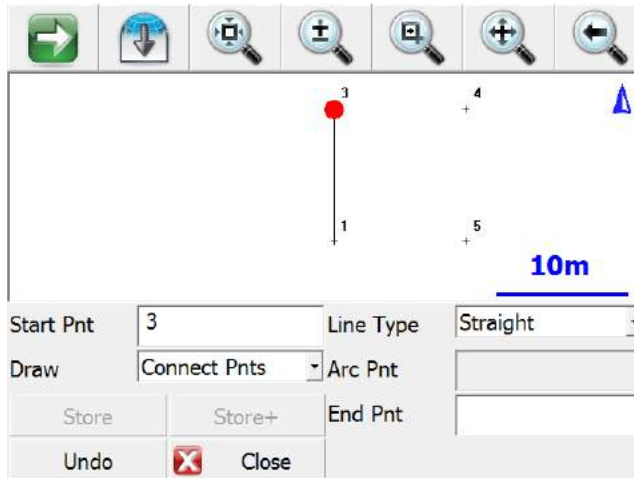

Start Point

Specify the start point for the new segment.

For starting a new plan, this should be set to an existing point in your Project, typically a corner that you will begin drawing the plan from.

As you continue connecting subsequent points to your plan, you will see the Start Point field automatically advance for you.

Line Type

Specify one of the five available methods to define your next figure segment:

- Straight: this will draw a straight line between the specified Start Point and End Point.
- Arc (CW): this will draw a clockwise arc between the specified Start Point and End Point, with the specified Radial Point.
- Arc (CCW): this will draw a counter-clockwise arc between the specified Start Point and End Point, with the specified Radial Point.
- Arc (3Pnt): this will draw an arc (clockwise or counter-clockwise) between the specified Start Point and End Point, going through the specified intermediate Arc Point (any point directly on the arc, does not need to be the midpoint).
- Spline: this will draw a curvy line between the specified Start Point and End Point.

Store / Store+

The Store and Store+ buttons are disabled for this mode, because new points are not being calculated for your Project. The line or arc segment will be automatically drawn into your Project after you specify its parameters.

Undo

Press the **Undo** button to undo the last segment you computed, removing both the point and/or the line segment (as appropriate) from your Project. You can undo multiple steps.

Note, there is no Redo function.

Close

Press the **Close** button to exit from the Draw Plan command, and you will be returned to the [map screen](#).

Smart Tags

When you select an existing or create a figure in your drawing you will see smart tags appear on the points that make up the figure.

Smart Tag "T"

The T smart tag define points connected to straight line segments.



Smart Tag "M"

The M smart tag defines the midpoint of an arc.

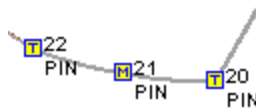

Smart Tag "C"

The C smart tag define points connected by a curvy line type.

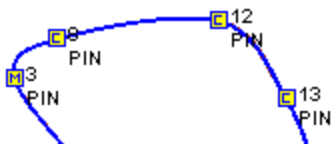

MAIN MENU

On the [main interface](#) of FieldGenius you will see the FieldGenius **Start** icon which will always activate the main menu or display the previously viewed sub-menu. When the button is pressed you will see the main menu screen:

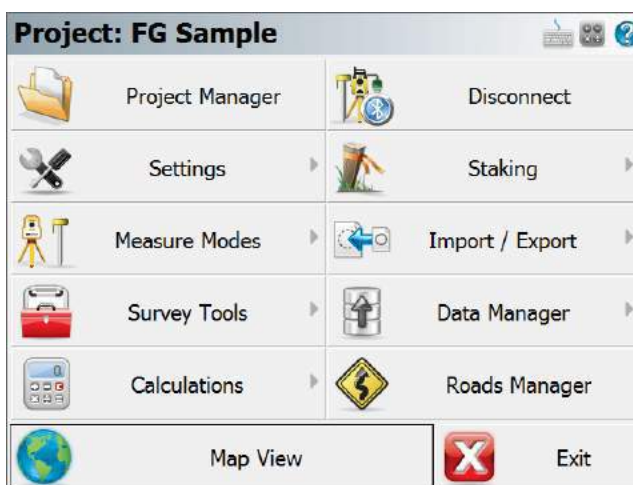

On the main menu, pressing any of the buttons will take you to its sub-menu. From any sub-menu, pressing the **Menu Home** button will return you to this menu. The **Map View** button will close the main menu and take you back to the map view. The **Exit** button will close FieldGenius.

Project Manager

Selecting this will allow you to create, open or delete Project. Please see the [Project Manager](#) topic for more information.

Settings

Select this to check or change settings for FieldGenius. Please see the [Settings](#) topic for more information.

Measure Modes

Select this to choose a Measure Mode such as occupying a point, checking a point, or measuring an offset. Please see the Measure Modes topics for more information.

Survey Tools

Select this to execute tools such as manually storing new points, deleting/undoing the previously measured point, or viewing the raw file. Please see the [Survey Tools](#) topic for more information.

Calculations

Select this to use our calculating functions such as COGO and inversing. Please see the [Calculations](#) topic for more information.

Staking

Select this to access our staking functions. Please see the [Staking](#) topic for more information.

Import/Export

Select this to import or export ASCII files, and to export DXF, XML, and other files. Please see the [Import/Export](#) topic for more information.

Please note, additional file types can be imported from the [Surface Manager](#) and the [Map Data Layers Manager](#), both located in the [Data Manager](#) menu.

Data Manager

Use this to manage your points, DXF files, and surfaces. Please see the [Data Manager](#) topic for more information.

Roads Manager

Use this to access tools that will help you create or edit alignments, templates, and profiles. Please see the [Roads Manager](#) topic for more information.

Project Manager

Main Menu | Project Manager

The Project Manager is used to create, open, or delete Projects stored on your data collector. When you start FieldGenius this is always the first screen you will see.

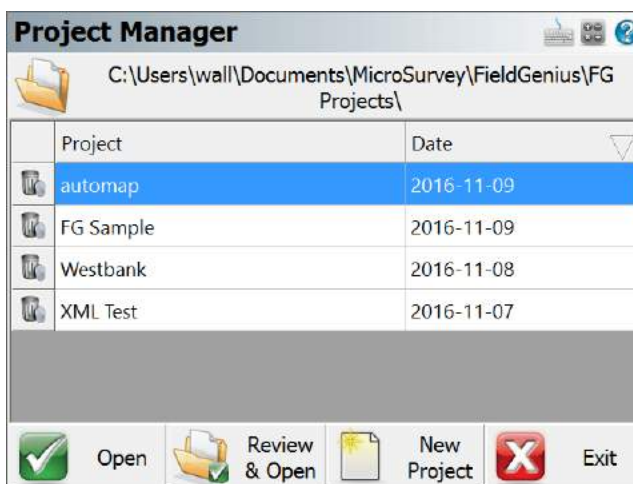

You can sort the list by Project name or date by tapping on the column's header.

FG Projects Folder

Press this button to specify a different Project folder than the default. The default is **...MicroSurvey\FieldGenius\FG Projects** (Windows CE/Mobile) or **...Documents\MicroSurvey\FieldGenius\FG Projects** (Windows Tablet/PC). Once you set the directory it is written to the MSurvey.ini file and is used for all subsequent Projects.

Delete Project

To delete a Project, pick the **Delete** trash can icon next to the Project Name. You will be asked to confirm that you really want to delete the Project.

Notes:

- You cannot delete a Project that is currently open
- Projects that have been deleted cannot be restored

Open Project

To open an existing Project, simply select it in the list and press the **Open** button.

Review & Open Project

To review and open an existing Project, simply select it in the list and press the **Review & Open** button. This option will display the Project files used with the Project.

New Project

To create a new Project, simply press the **New Project** button. You will then see the New Project screen which will allow you to enter a name, choose your AutoMap library and set the units for the Project.

Exit

To exit from the Project Manager press the **Exit** button.

Settings Menu

Main Menu | Settings

The settings menu is used to setup and review settings that have been set for your current Project. You can also specify default settings for new Projects that are created.

Most of these settings are stored in a file named **MSurvey.ini** which can be found in the ...**MicroSurvey\FieldGenius\Programs** (Windows CE/Mobile) or ...**ProgramData\MicroSurvey\FieldGenius\9** (Windows Tablet/PC) directory. It is recommended that once you have defined your settings, that you make a backup of this **MSurvey.ini** file.

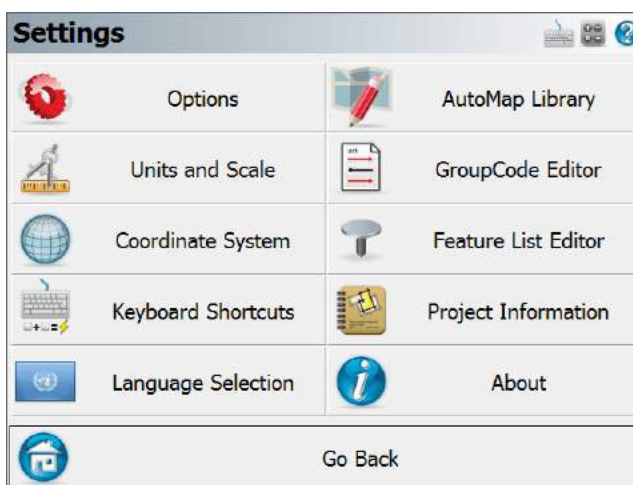

Options

Use this to set or change settings that affect FieldGenius's functionality. Please see the [Options](#) topic for more information.

Units and Scale

Use this to set or change the units, bearings, distances and scale settings for your Project. Please see the [Units and Scale](#) topic for more information.

Coordinate System

Use this to define the coordinate system for your Project. Please see the [Coordinate System Settings](#) topic for more information.

Keyboard Shortcuts

Use this to define shortcuts to FieldGenius commands and assign them to your keys. Please see the [Keyboard Shortcuts](#) topic for more information.

Language Selection

Pick the Language for the program interface. Many options are available, see the [Language Selection](#) topic for more details.

AutoMap Library

The AutoMap Library editor, see the [AutoMap Library](#) topic for more details.

GroupCode Editor

The GroupCode editor, see the [GroupCode Editor](#) topic for more details.

Feature List Editor

Launch the external Feature List Editor (Windows Tablet/PC only). See the [Feature List Editor](#) topic for more information.

Project Information

Use this to enter and save information about your Project. Please see the [Project Information](#) topic for more information.

About

Opens the [About](#) screen.

Options

[Main Menu](#) | [Settings](#) | [Options](#)

The options screen helps you set settings that affect the look and feel of FieldGenius.

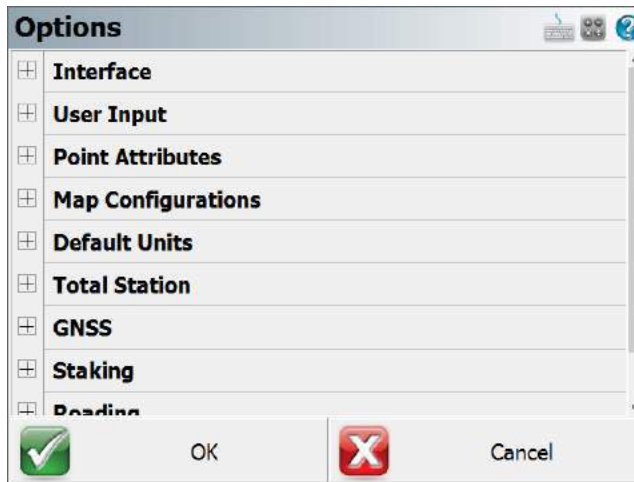

Press the [+] buttons along the left to expand (show) each section, and the [-] buttons to collapse (hide) it.

- [Interface Options](#)
- [User Input Options](#)
- [Point Attributes Options](#)
- [Map Configurations Options](#)
- [Default Units Options](#)
- [Total Station Options](#)
- [GNSS Options](#)
- [Staking Options](#)
- [Roading Options](#)
- [System Options](#)

Interface Options

Map Colour

Use this to force the background color for the main drawing area to be white or black

Map Orientation

Using this will force the map screen to be oriented to the north or south. This is needed for coordinate systems that are referenced south, such as in South Africa. This is different from South Azimuth directions, as used in Hawaii.

Arc Resolution

This option determines the number of segments that will be displayed in an arc on the screen. Reducing this number increases program speed; increasing this number slows down graphics display, but improves the quality of arcs and curvy lines displayed on the screen.

Text Size (Info/Grid)

Use this to force the text shown in the Information screens (such as the Observation toolbar and the COGO History screen) and grid screens (such as the Project Manager and Angle Offset shots) to use a small or large sized text.

Show Scale Bar

Use this to turn the scale bar shown on the main map screen on or off.

Scrollbar Width

Use this to increase the width of the scroll bar on the map screen.

User Input Options

Keypad Text Color

Use this to turn change the keypad text color to show up better against the keypad background color.

Keypad Background Color

Use this to turn change the keypad background color so the text shows up better.

Extended Edit Boxes

Use this to control how you want to bring up the selected keypad when tapping in an edit box: either with a single tap, a double tap, or off. Users of devices with a keyboard should leave this set to Double Click, and users of devices without a keyboard should set this to Single Click. Setting this to Off disables both the keypad and any other commands that may be started directly from the edit field, such as the Point Chooser or Inverse Tool, so that edit fields can only be used for typing values from your physical keypad.

Menu Shortcuts

This will enable menu shortcuts so if you have a keyboard device you can press letter and number keys to navigate around the program.

Instrument Toolbar

You can define if the instrument toolbar is located on either the Right or Left Side of your map screen.

SIP Type

Use this to specify which SIP keypad type you want to use on a Windows Mobile device.

Point Attributes Options

Coordinate Order

Use this to control the display of coordinate values in FieldGenius. Options are NEH, ENH, XYZ, XYZ (South) and YXZ (South) affecting any area of the program where coordinates are displayed.

This option also affects whether the [ASCII Import](#) and [ASCII Export](#) commands use a N,E or E,N (X,Y) file format.

Alphanumeric IDs

When this is enabled you will be allowed to enter Alphanumeric Point IDs such as 21a, AB3, EV2. If this isn't turned on, then FieldGenius will not accept anything but integer numbers. Alphanumeric input of Point IDs can contain up to 31 characters.

Alphanumeric Case Sensitive

When this is enabled the Point ID that is used as a unique identifier will be case sensitive, points a1 and A1 will be recorded as 2 separate points.

Notes:

The Case Sensitive setting is applied when the user stores a measured, calculated, or manually entered point and FieldGenius needs to determine if the Point ID already exists. In other cases the setting is not used, specifically:

- **Importing Points:** When importing points the setting will not be applied. FieldGenius will treat the Point IDs as Case Sensitive, regardless of what the setting is.
- **Point Ranges:** Point ranges will be handled as Not Case Sensitive.
- **Sorting Points:** The Point Database and other sorting applications will always sort as Not Case Sensitive.
- **Point Query:** Specifying a Point ID as input will always require an exact match and is Case Sensitive.

Point ID Range - Minimum

Use this to force FieldGenius to limit the point numbers that are used to a specific range; here you would specify the minimum range value. If you try to use a point number that is less than this value, you will see a message that will ask you to select a different point number. **Note:** If you have the Alphanumeric IDs toggle turned on, a natural order sort algorithm determines if a Point ID falls within the range.

Point ID Range - Maximum

Use this to force FieldGenius to limit the point numbers that are used to a specific range; here you would specify the maximum range value. If you try to use a point number that is greater than this value, you will see a message that will ask you to select a different point number. **Note:** If you have the Alphanumeric IDs toggle turned on, a natural order sort algorithm determines if a Point ID falls within the range.

Alphanumeric Point ID's can have a maximum length of 31 characters.

Point ID Intervals

Enter the value that the next point will automatically increment by. The default is 1 and consecutive points will be recorded as 1,2,3 ... If the Point ID interval is set to 2 consecutive points will be recorded as 1,3,5,7...

LandXML Export - Prefix IDs

When this is enabled, point numbers will be prefixed with the point's description upon creation of an XML file. For example, if a point has a number of 100 and description of PIN, in the XML file its ID will be PIN100.

New Description Prompt

This controls how FieldGenius deals with descriptions that don't match anything in your AutoMap library. If this is on, when you enter a description that isn't in the AutoMap library you will see a warning message asking you if you want to add it.

If it is off, any description that doesn't have a match in the AutoMap library will be automatically added to your Project's AutoMap library.

Time Stamp Saved Points

This tells FieldGenius to write a timestamp into the raw file whenever a point is stored.

Write Notes to Raw File

When this option is enabled, the text note recorded for a specific point will be written to the Raw file as a comment.

Map Configurations

Show ID

This is used to show or hide the point number labels for your points.

Show Description

This is used to show or hide the point description labels for your points.

Show Elevation

This is used to show or hide the point elevation labels for your points.

Level of Detail

The Level of Detail filter, when turned off, will force FieldGenius to show the point labels all the time, independent of your zoom level. If it is turned on, FieldGenius uses an algorithm to determine if displaying the point labels is necessary.

This is demonstrated in the following two images, the first has LOD turned on and the second has LOD turned off.



With LOD on, as soon as you zoom in to a reasonable level, the labels will appear automatically. Under normal circumstances you will keep the LOD feature active.

Text Size (Map View)

Use this to change the default text size that is used on the Map View.

Map Position Select

If this is turned on, tapping a blank part of the map screen will display the [Map Select Toolbar](#).

Map Point Select

If this is turned on, then tapping on a point from the map screen will select the point tapped and show it as a blue circle and open the [Point Toolbar](#). The point can then be saved as a recorded point in your Project.

Map Line Select

If this is turned on, then tapping on a line from the map screen will select it and open the [Line Toolbar](#).

Map DXF Entity Select

If this is turned on, then tapping on a DXF entity will highlight it. If turned off then the DXF file will behave like an underlay and is not selectable.

Default Units Options

These options provide the default settings shown in the [Units & Scale](#) screen when creating a new Project; they do not necessarily reflect the actual settings for the current Project. Please see the [Units & Scale](#) topic for more detailed information on each option.

Distance Unit, Format, Precision

Specify whether new Projects should default to Meters or Feet, in which format, and with how much precision.

Angle Unit, Format, Precision

Specify whether new Projects should default to Degrees, Radians, or Gons/Grads, in which format, and with how much precision.

Direction Format

Specify whether to use Bearings or Azimuths by default for new Projects.

Scale

Specify the default ground-to-grid scale factor to use for new Projects.

Corrections

Specify whether to enable or disable the "Curvature and Refraction Corrections" option by default for new Projects.

Total Station Options

Default Measure Mode

This specifies which Measure Mode FieldGenius will default to, either Sideshot or Sideshot (Auto).

Quick Measure Modes

When this is turned on, when you press the Measure button in routines such as the Horizontal Angle Offset or Resections screens, it will force the instrument to take a measurement instantly. If this is turned off, then pressing the Measure button will take you back to the map screen where you have to press the measure button on the instrument toolbar to take a measurement.

If you're using a robotic instrument you will probably want to keep this turned off.

Traverse Reciprocate

When this is turned on, you will be able to use the Reciprocate Traverse option on the Backsight Summary screen, when occupying a traversed point. This recalculates your setup point's position, based on an average of the traverse shot to the point being occupied and the backsight shot from the point being occupied. If this is turned off, then the Reciprocate Traverse option within the Occupy Point routine will be grayed out. For additional details, please refer to the [Backsight Summary](#) topic.

Display Use Last Setup Screen

When this option is turned on, you will be offered to the choice to use the last instrument occupied point when for an existing Project is opened. This is useful if the program is inadvertently closed in the middle of a Project and the instrument has not moved from the last occupied point. You can start work again without having to backsight and reestablish the instrument location.

Use Assistant on Open

The Total Station Assistant suggests workflow shortcuts when opening a Project.

GNSS Options

EP+ Records

Toggle the format of the EP record written to the raw file. The standard EP record contains a combined horizontal RMS value, while the EP+ record contains RMS values for Northing and Easting. EP+ records are required when seeding positions with regards to L-band correction services.

Post Processing Tagging

Start and End times of GNSS measurements can be written to the raw file as comments. These values are required for post processing raw data with Effigis OnPOZ (EZSurv) software. **NOTE:** End times are captured when the user picks the **Store Position** button on the GNSS Measurement dialog.

Leap Seconds (GPS-UTC)

Some receivers report UTC time instead of GPS time. When writing Start and End times for GNSS measurements, the Leap Seconds value will be applied to the UTC time to ensure GPS time is recorded. **NOTE:** This value will change over time and is the responsibility of the user to ensure it is current. This value only applies to those receivers that report UTC time.

Prompt Raw Logging

Raw data logging on most receivers must be manually initialized. A prompt can be displayed at connection time to remind the user to start raw data logging on the receiver.

Test Incoming Data Stream

Some GNSS receivers automatically connect to the previous correction link. FieldGenius can test for incoming corrections at connection time to eliminate the Link Configure step.

Display GNSS Reference Setup

When connecting to a reference receiver, a prompt can be displayed to remind the user of the steps to take to complete a reference setup.

Staking Options

Note: You can also access these options directly from the [staking toolbar](#).

Tolerance

This is the error tolerance that the staking command will use. When your staking "move by" distances are equal to or less than this amount, your direction to a point will be indicated in green text in the Observation Toolbar at the top left hand corner of the screen. Green text will be displayed to notify you that you're meeting your tolerance; if you do not meet the tolerance, the text will switch to red.

Orientation Total Station

The user can set an orientation preference for a Total Station layout. Depending on the equipment currently in use, FieldGenius will automatically use the defined orientation.

Orientation North (Cardinal)

With the North orientation, North is the reference direction. The "move by" distances are standard cardinal directions.

North: This is the distance you need to move North.

South: This is the distance you need to move South.

East: This is the distance you need to move East.

West: This is the distance you need to move West.

Cut: This is the amount you have to go down from the current rod position to the stake point's elevation.

Fill: This is the amount you have to go up from the current rod position to the stake point's elevation.

Orientation North (Directional)

With the North orientation, North is the reference direction. The "move by" distances are indicated by arrows showing the direction of the movement.

Up arrow: This is the distance you need to move North.

Down arrow: This is the distance you need to move South.

Right Arrow: This is the distance you need to move East.

Left Arrow: This is the distance you need to move West.

Cut: This is the amount you have to go down from the current rod position to the stake point's elevation.

Fill: This is the amount you have to go up from the current rod position to the stake point's elevation.

Instrument

With the staking reference set to Instrument the map view will be twisted so the instrument is centered towards the top of your screen. The "move by" distances are with respect to the rod position looking towards the instrument. This view is useful when using a robotic instrument.

In: This is the distance you need to move towards the instrument.

Out: This is the distance you need to move away from the instrument.

Right: Facing the instrument, move right by this amount.

Left: Facing the instrument, move left by this amount.

Cut: This is the amount you have to go down from the current rod position to the stake point's elevation.

Fill: This is the amount you have to go up from the current rod position to the stake point's elevation.

Prism

With the staking reference set to Prism the map view will be twisted so the prism is centered towards the top of your screen. The "move by" distances are with respect to the instrument man looking at the prism. This view is handy when using a non-robotic instrument.

In: This is the distance you need to move towards the instrument.

Out: This is the distance you need to move away from the instrument.

Right: Facing the prism, move right by this amount.

Left: Facing the prism, move left by this amount.

Cut: This is the amount you have to go down from the current rod position to the stake point's elevation.

Fill: This is the amount you have to go up from the current rod position to the stake point's elevation.

User Point

With the User Point orientation, you can use an existing point in your Project as the reference. The view will be twisted so that the selected point is centered towards the top of your screen.

In: This is the distance you need to move towards your user reference point.

Out: This is the distance you need to move away from your user reference point.

Right: Facing your user reference point, move right by this amount.

Left: Facing your user reference point, move left by this amount.

Cut: This is the amount you have to go down from the current rod position to the stake point's elevation.

Fill: This is the amount you have to go up from the current rod position to the stake point's elevation.

Line

With the staking reference set to Line the map view will be twisted so the line is drawn vertically with the start of the line at the bottom of the screen and the end of the line at the top of the screen. The "move by" distances are with respect to the line.

In: You will not be given an In distance.

Out: You will not be given an Out distance.

Right: Looking down the line (or parallel to it), move right by this amount perpendicularly towards the line.

Left: Looking down the line (or parallel to it), move left by this amount perpendicularly towards the line.

Cut: This is the amount you have to go down from the current rod position to the stake line's interpolated elevation.

Fill: This is the amount you have to go up from the current rod position to the stake line's interpolated elevation.

Orientation GNSS

The user can set an orientation preference for a GNSS layout. Depending on the equipment currently in use, FieldGenius will automatically use the defined orientation.

Orientation North (Cardinal)

With the North orientation, North is the reference direction. The "move by" distances are standard cardinal directions.

North: This is the distance you need to move North.

South: This is the distance you need to move South.

East: This is the distance you need to move East.

West: This is the distance you need to move West.

Cut: This is the amount you have to go down from the current rod position to the stake point's elevation.

Fill: This is the amount you have to go up from the current rod position to the stake point's elevation.

Orientation North (Directional)

With the North orientation, North is the reference direction. The "move by" distances are indicated by arrows showing the direction of the movement.

Up arrow: This is the distance you need to move North.

Down arrow: This is the distance you need to move South.

Right Arrow: This is the distance you need to move East.

Left Arrow: This is the distance you need to move West.

Cut: This is the amount you have to go down from the current rod position to the stake point's elevation.

Fill: This is the amount you have to go up from the current rod position to the stake point's elevation.

User Point

With the User Point orientation, you can use an existing point in your Project as the reference. The view will be twisted so that the selected point is centered towards the top of your screen.

In: This is the distance you need to move towards your user reference point.

Out: This is the distance you need to move away from your user reference point.

Right: Facing your user reference point, move right by this amount.

Left: Facing your user reference point, move left by this amount.

Cut: This is the amount you have to go down from the current rod position to the stake point's elevation.

Fill: This is the amount you have to go up from the current rod position to the stake point's elevation.

User Line

TBD"

Line

With the staking reference set to Line the map view will be twisted so the line is drawn vertically with the start of the line at the bottom of the screen and the end of the line at the top of the screen. The "move by" distances are with respect to the line.

In: You will not be given an In distance.

Out: You will not be given an Out distance.

Right: Looking down the line (or parallel to it), move right by this amount perpendicularly towards the line.

Left: Looking down the line (or parallel to it), move left by this amount perpendicularly towards the line.

Cut: This is the amount you have to go down from the current rod position to the stake line's interpolated elevation.

Fill: This is the amount you have to go up from the current rod position to the stake line's interpolated elevation.

Compass Switch Threshold

This allows a user to input a distance within which the compass on a Total Station.

Attached User ID

Use this to add a value to the point number you're currently staking. For example if the point you're staking is point 8, and this field is set to 1000. In the raw file it will show that you staked point 1008 and will also store the staked position as point 1008 in the Project database.

Line Mode

Use this to control how your navigation distances are computed and displayed when staking a Line.

In Auto mode, FieldGenius will automatically determine if it should display in/out or left/right offsets to the line. Auto mode will display in/out distances if the line of sight intersects the line equal or greater than 45° (In/Out); if it is less than 45° then FieldGenius will display (Left/Right) offsets to the line.

You can force FieldGenius to always display In/Out distances to the line by setting it to In/Out.

Use Left/Right to always see the Left/Right offset to the line.

If you're staking an arc, FieldGenius will always display in/out offsets no matter what line mode setting FieldGenius is set to.

This option has no effect if you have selected the "Line" Orientation Reference option.

Robotic Prism Tracking

When selected the robotic total station will track the prism as the user moves it across the scene site.

Turn Instrument Mode

If you have a motorized instrument, including robotics, you can control how FieldGenius turns the instrument during stakeouts. If you want FieldGenius to compute the horizontal and vertical angle needed to stake your point, use the **3D (HA + VA)** option. If all you want is the horizontal angle to be turned, and the vertical left alone, select the **2D (HA)** option.

Cut and Fill Slopes

Use this to specify your cut and fill slopes when you're slope staking. The fill slope value will be used when the hinge point is higher than the calculated catch point and this will occur in areas that require a fill. The cut slope will be used when the hinge point falls below the calculated catch point. This will occur in areas that require a cut.

A Cut of 2:1 means you would have a cut of 1 unit for every 2 units traveled horizontally.

DTM Staking Name

Use this to select a surface that will be used to compute a new z value for the design point. When you select a surface you need to have the Stake to DTM toggle checked. **Once this is turned on, the elevation for any point you stake will be computed using this surface. In other words, if you're doing point staking and the point has a design elevation, it will be ignored. The stake point's N & E will be used to intersect a point on the surface and that elevation will be used to stake the point.**

Fade Staked-Out Points

Place a check mark in this box if you would like to see staked out points displayed differently to non-staked out points. A staked out point will appear as a slightly greyed out inverted triangle. This is for you to make quick assessments of what has been done and what remains to be finished.

Display Point Staking Screen

Place a check mark in this box if you would like to see the Point Staking screen displayed. This screen will always be displayed if there are values in the Design Point Offset fields. This was done to ensure that you never stake a point with a forgotten (and wrong) offset.

Display Stake Result Screen

Place a check mark in this box if you would like to see the Stake Result screen displayed after staking out a point. This screen will always be displayed if the staked out point exceeds the staking tolerances.

Store Stake Point

Place a check mark in this box if you would like the staked out point to be stored along with the raw data. If no check mark is in this box then only the raw data is stored, and the Store Point dialog will not be displayed.

By default this is checked. What will happen is when you store a staked position using the store button on the stake toolbar you will be prompted with a screen allowing you to assign a point number and description to the new point that will be created.

The point description will default to the current description from the AutoMap Library, as shown on your topo toolbar. If you choose a different description from the library, then it will be retained for all consecutive stakeout points.

Furthermore, when this feature is turned on it will use the value in the Add Id field to determine the point number for the recorded staked position. For example if you staked point 19 and you have an Attached User Id = 1000, then FieldGenius will automatically use 1019 as a point number. This can be changed by the user.

Show Staked-Stored Points

Place a check mark in this box if you would like to see the staked out point displayed on map. We provide you with the choice so that you can quickly see which points you have already staked out.

Use Stake List

Place a check mark in this box if you would to use the Staking list instead of staking out from the Points database. If you use a staking list, you will never have a measured point presented as a new point to stake out.

Find Next Nearest

Place a check mark in this box if you would like FieldGenius to search in the Points database (i.e. not in the staking list) for the nearest point from the current position, and present it as the next point to be staked out.

Roading Options

Stationing Format

You can specify the format for your stations.

Value	Stationing Format		
	0+000.000	0+00.00	0.000
10	0+010.000	0+10.00	10.000
100	0+100.000	1+00.00	100.000
1000	1+000.000	10+00.00	1000.000
10000	10+000.000	100+00.00	10000.000

Force Tangential

Place a check mark in this box if you would like to automatically enforce the direction of alignment geometry elements so they remain tangential to previous geometry elements. This rule can be useful to ensure the alignment geometry elements maintain a common tangent direction between adjacent elements.

Dynamic Horizontal Alignment

Place a check mark in this box if you would like changes to the direction of alignment geometry elements to be applied to subsequent geometry elements. To illustrate: modify the direction of a line geometry element by 10° clockwise. With this feature is enabled, all geometry elements following the modified line will also be rotated by 10° clockwise. With this feature is disabled, only the single line element will be rotated by 10°.

System Options

Show Tool Tips

When turned on, a "Tip of the Day" will be displayed when FieldGenius is started, and tooltips will be displayed when you hover over any button.

Turning this off will hide the "Tip of the Day" dialog and will disable tooltips on buttons.

Communication Trace File

When turned on it will create a log file of the communication between FieldGenius and your instrument, which can be used to diagnose communication problems and should only be used in this situation. The text file will be named **TraceTS.txt** or **TraceGNSS.txt** and will be created in the ...\\Program Files (x86)\\MicroSurvey\\FieldGenius\\9\\ directory on your device.

Always Auto-Reconnect

When turned on it the program will always attempt to reconnect if communication drops between the device and the collector.

Datum Warning Dialog

When turned on a warning will show up when the datum is changed so the user can move to use a new datum.

Unit Settings

Main Menu | Settings | Units and Scale

The units and scale menu allows you to specify settings for your Project. Some of these settings are recorded in the raw file and the Project's **INI** file, as well as recorded in the MSurvey.ini file.

Notes:

The Distance Unit (Meters or Feet) and Angle Unit (Degrees, Radians, or Gons) can only be set when creating a new Project. After a Project has been created, these will remain greyed-out and cannot be changed.

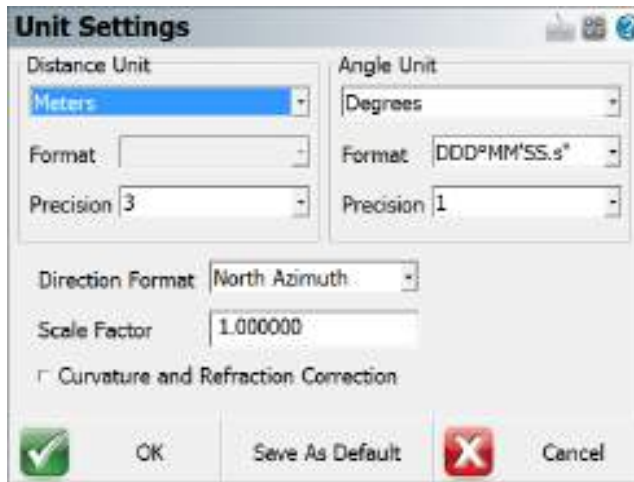

You can set these settings as defaults for new Projects by pressing the **Save as Default Settings** button. The default settings can also be set in the [Options](#) screen.

Note: the actual precision on distances and angles returned from your instrument may be limited to less than the precision you select here. Selecting a higher precision here will not increase the precision of values queried from your instrument.

Distance Unit

Choose the distance unit that you will be using: Meters, International Feet, or US Survey Feet. All distances will be displayed in the selected format. All distances will be recorded to the raw file in decimal format. Database coordinates are always stored with 6 decimal places, and rounded to the desired precision for display.

Meters

If you choose Meters as your distance unit, you can also specify the number of decimal places to display within FieldGenius, from 0 to 6.

International Feet / US Survey Feet

If you choose International Feet or US Survey Feet, then you can specify to use either a decimal format with a precision from 0 to 6, or a Fractional format with feet and inches.

If you use the **decimal** format, distances will be displayed in decimal feet, such as 10.5' to indicate 10.5 feet or 10feet-6inches.

If you use the **fractional** format, distances will be displayed in feet and fractional inches, such as 10'6 1/2" to indicate 10feet-6.5inches or 10.54166667 feet.

Angle Unit

Choose the angular unit that you will be using: Degrees, Gons/Gradients, or Radians. All angular values written into the raw file will be recorded in the selected format.

Degrees

If you select Degrees, then you can also select which format to use, either DDD°MM'SS.s" for degrees-minutes-decimal seconds, DDD°MM.m' for degrees-decimal minutes, or DDD.d° for decimal degrees. You can also specify the number of decimal places to use, from 0 to 8.

Gons (Gradients)

If you select Gons (Gradients) then you can also specify the number of decimal places to use, from 0 to 8.

Radians

If you select Radians then you can also specify the number of decimal places to use, from 0 to 8.

Direction Format

Choose the direction format that you will be using: North Azimuth, South Azimuth, or Bearings. When entering a direction, you can always override this setting by entering the angle with the cardinal quadrant indicated before or after the angle. If there is no quadrant specified, then the input angle will be interpreted as an Azimuth.

Scale Factor

You can use a scale factor to adjust ground distances to grid distances.

Distances measured with a total station will be recorded in the raw file with the unscaled, true measured slope distance. This scale factor is applied to the computation of coordinates only.

Distances entered using the Traverse/Intersect tool (COGO) will be scaled by the scale factor.

Distances calculated using the Inverse tool, or recalled using the pt..pt format will be scaled by the inverse of this scale factor. The result will be the inversed grid distance times the inverse of the scale factor, so that the ground distance is returned.

This Scale Factor does not affect any GNSS measurements. Please see the [GNSS Local Transformation](#) topic for information on using a GNSS Scale Factor.

Curvature and Refraction Correction

When selected, the correction is applied to the computation of drawing coordinates only. Raw data will not be altered in any way. When available from your instrument, we recommend the use of that option and leave this setting toggled OFF in FieldGenius. Note: Be careful to not have this setting toggled ON in both your instrument AND FieldGenius.

Save As Default

Use this to permanently write the current settings to the MSurvey.ini file. When you create a new Project, it will use these settings. The default settings can also be set in the [Options](#) screen.

Coordinate Systems

Coordinate System Settings

[Main Menu](#) | [Settings](#) | [Coordinate System](#)

The coordinate system settings are used to transform GNSS derived curvilinear coordinates (latitude, longitude and ellipsoidal height) into Cartesian coordinates (northing/y, easting/x, and ellipsoid or orthometric height) for presentation on the drawing window and data storage.

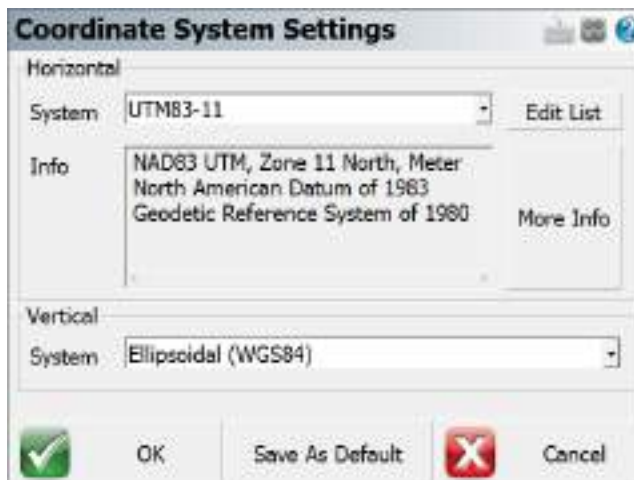

Horizontal Group

Set the horizontal projected coordinate system for your Project.

The default coordinate system in FieldGenius is set to **UTM83-11**. Change this coordinate system as appropriate for your region.

Edit List

The **Edit List** button opens the [Coordinate System List](#) dialog, which is used to add predefined or user-defined coordinate systems to the list of selectable systems, create new coordinate systems, copy predefined systems, and edit or delete existing systems.

A **predefined coordinate system** is one that is included with FieldGenius by default, a **user-defined system** is one that you have created.

More Info

Displays details about the selected coordinate system, including:

1. Ellipsoid parameters
2. The datum transformation method and parameters
3. The projection type and parameters

Vertical Group

Set the vertical system for your Project.

The default vertical datum is set to **Ellipsoidal (WGS84)**, meaning that all GNSS derived heights will be referenced to the WGS84 ellipsoid. The list of available systems includes all valid geoid model files that are present within the Mapping directory of your FieldGenius installation. A geoid model is required to reference GNSS derived heights to a geodetic datum. Please review the [Geoid Model](#) topic for more details.

Save As Defaults

Saves the Horizontal and Vertical systems to the MSurvey.ini file as defaults to be used for all new Projects.

Coordinate System List

The Coordinate System List dialog is where you can select an existing coordinate system or create a new user-defined coordinate system and add them to a "favourites" list.

This list allows you to define the coordinate systems you uses most often for easy access from the Coordinate System Settings screen.

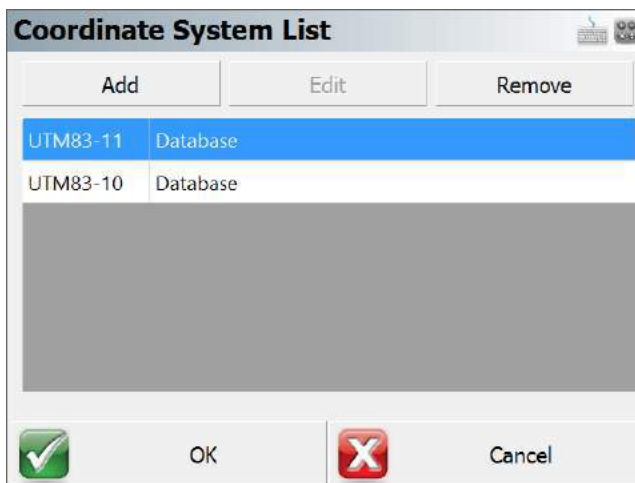

Add

Add a new coordinate system to the list by one of three methods:

1. **Select Coordinate System From Database** - Select one of the predefined coordinate systems. Coordinate systems are grouped into countries or mapping systems. Select the country or system that you are surveying in and then choose the coordinate system in the System drop down list. The section below the System field displays the projection, datum, and ellipsoid information related to this coordinate system.

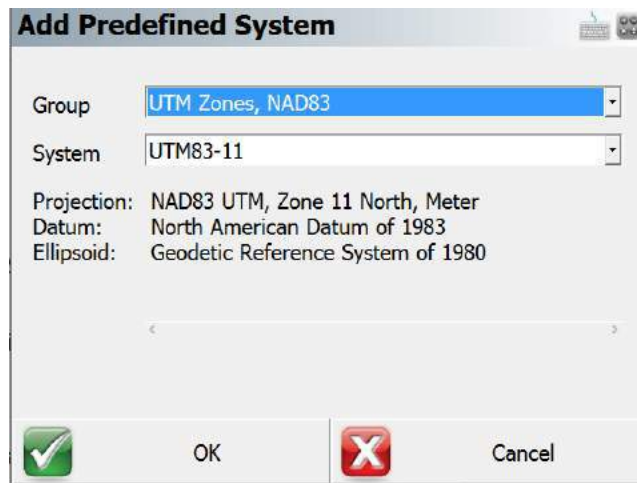

2. **Create New User Coordinate System** - Create a completely new coordinate system from scratch with known parameters. Enter a name for your coordinate system and optionally enter

a description. **NOTE: The system name must have colon in the name.**

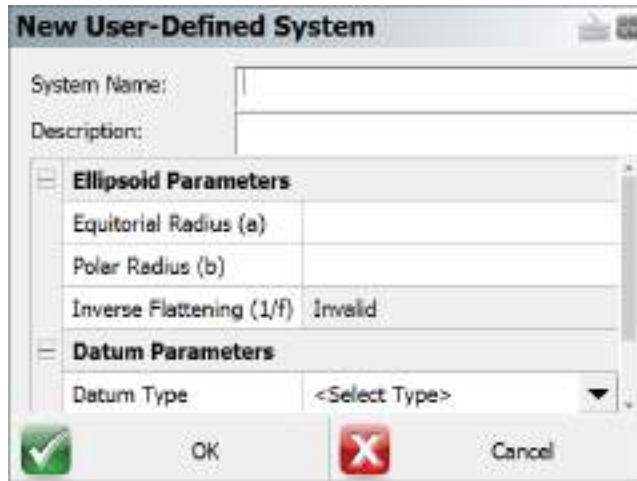

3. **Create New User Coordinate System From Database Selection** - Choose a predefined coordinate system to populate parameters for a new coordinate system.

Edit

Edit a user-defined coordinate system. It is not possible to edit predefined coordinate systems.

Remove

Remove the selected coordinate system from the list. If the coordinate system is user-defined; you will have the option to permanently delete the coordinate system. You may want to use the [User Coordinate System Export](#) routine to save a backup copy of your user-defined coordinate system before removing it permanently.

OK Button

This will save the coordinate system favourites list to the MSurvey.ini file.

Cancel Button

This will exit the dialog and will save nothing. You will be automatically returned to the Coordinate System Settings dialog.

New / Edit user-defined Systems

Ellipsoid Parameters

To define the ellipsoid for the coordinate system you must enter the known equatorial and polar radiuses for the ellipsoid. The Inverse Flattening is not editable and will be computed automatically and can be used a check.

- Equatorial Radius (a)
- Polar Radius (b)
- Inverse Flattening (1/f) - Always a read only value, automatically computed from the two ellipsoid radiuses.

Datum Parameters

There are 7 datum types to select from:

- Three Parameter
- Four Parameter
- Six Parameter
- Seven Parameter
- Bursa / Wolf
- DMA Molodensky
- None

If none is selected then no transformation parameters will be applied to the coordinate system transformation.

If a datum other than none is selected then the user will be able to enter the following parameters:

- Delta X (m)
- Delta Y (m)
- Delta Z (m)
- X Rotation (")
- Y Rotation (")
- Z Rotation (")
- Scale (PPM)

Projection Parameters

The user can select one of nineteen projections.

- Lambert Conformal Conic (One Standard Parallels)
- Lambert Conformal Conic (Two Standard Parallels)
- Transverse Mercator or Gauss Kruger
- Universal Transverse Mercator
- Albers Equal Area Conic
- Rectified Skew Orthomorphic, Azimuth at Projection Center
- Mercator Cylindrical Projection with Standard Parallel
- Mercator Cylindrical Projection with Scale Reduction
- Lambert Azimuthal Equal Area
- Lambert Azimuthal Equidistant
- Miller Cylindrical
- Oblique Sterographic
- Polar Sterographic
- Sinusoidal Projection, Optionally Interrupted
- Equidistant Cylindrical
- Cassini
- Robinson Cylindrical
- Bonne Pseudoconical
- Krovac Oblique Conformal Conic, Czechoslovakia

Typical projection parameters for most cases are:

- Scale Factor
- Central Meridian
- Origin Latitude
- Origin Longitude
- False Northing
- False Easting

Automatic Backup

Whenever you add or edit a user-defined coordinate system, FieldGenius will automatically create and save your parameters to a file named **user-coordsys-backup.csm** to the mapping directory.

This backup file stores your user-defined coordinate systems. If you accidentally remove or overwrite your user-defined coordinate systems, you can re-import them from this backup file using the [Import user-defined Coordinate System](#) command.

Localization (Site Calibration)

Further coordinate transformations can be accomplished with the use of the Local Transformation function of FieldGenius. See the [GNSS Local Transformation](#) section for more information.

These settings are stored in your Project's **INI** file, allowing you to easily use different coordinate systems for different Projects.

Geoid Models

Geoid models are used by FieldGenius to convert ellipsoid heights to orthometric heights. FieldGenius will by default use ellipsoid heights but you can define a geoid model to be used instead if orthometric heights are desired.

Geoid models are not installed by default and must be downloaded from the MicroSurvey website. Geoid models are available for most regions around the world.

Download Files and Instructions

Please review the following MicroSurvey Helpdesk article for instructions and country specific geoid models: <http://helpdesk.microsurvey.com/index.php?/Knowledgebase/Article/View/479>

Grid Shift Files

In some countries, or areas, the use of grid shift files are required to accurately compute a horizontal position. When projecting a dataset between two different datums, a transformation is required.

Both equation-based and grid-based transformation methods are supported by FieldGenius. An equation-based transformation can use either a 3-parameter (dX, dY, dZ) or a 7-parameter transformation (dX, dY, dZ, rX, rY, rZ, ds) to translate between coordinate systems. A grid-based transformation uses binary files and interpolations that calculate the differences between the two geographic coordinate systems.

We have created country specific grid shift files and these additional grid shift files are not installed by default and need to be downloaded from the MicroSurvey website.

Download Files and Instructions

Please review the following MicroSurvey Helpdesk article for instructions and country specific grid shift files: <http://helpdesk.microsurvey.com/index.php?/Knowledgebase/Article/View/499>

Keyboard Shortcuts

[Main Menu](#) | [Settings](#) | [Keyboard Shortcuts](#)

You can now assign command shortcuts to keys on your data collector. This has been added to support our new keyboard layout on the newer Trackers but it also works with any device that has a keyboard.

The defaults for the shortcut keys are based on the MicroSurvey Tracker custom keyboard layout, but you can assign any key you want to the list of available commands. The shortcut definitions are stored in the MSurvey.ini file so they're portable to your other data collectors if you've defined a custom layout.

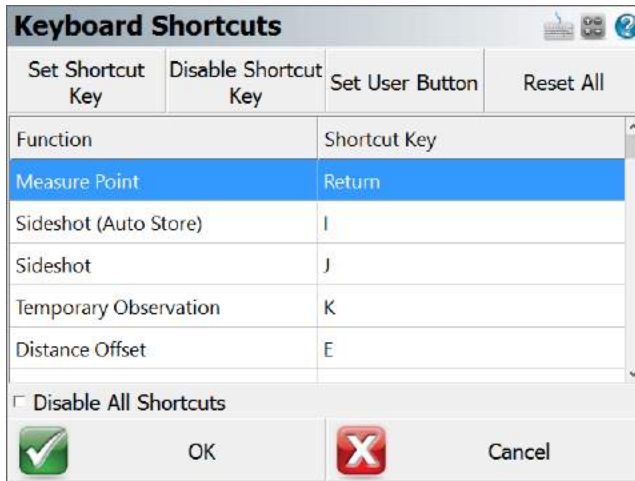

Another great feature is that the EDM mode for the current instrument you have selected can have shortcut keys assigned to them. For example if you refer to the list above, you would press the 1 key to set your EDM mode on the instrument to IR Standard.

The shortcut keys will only function from the [map screen](#).

Set Shortcut Key

Use this to assign a command to a key on your keyboard. Highlight the command you want to modify, press the **Set Shortcut Key** button, then press the button on your keyboard to map the command to it. Your new key map will automatically be saved to the MSurvey.ini file.

Disable Shortcut Key

Use this to disable individual shortcuts.

Set User Button



Use this to set the currently selected command to the User Button found on the main interface. The command currently set with the user button is indicated in the Function list with the same icon.

Reset All

This resets all the shortcuts to the factory defaults and all customized settings will be lost.

Disable All Shortcuts

This is a toggle that controls if the shortcut keys are disabled or enabled.

Default Shortcut Keys

Function	Shortcut Key
Measure Point	Enter
Sideshot (Auto Store)	I
Sideshot	J
Temporary Observation	K
Distance offset	E
Horizontal Angle Offset	A
Multi-Set	M
Resection	R
Set Target Heights	T
Occupy Point	O
Check Backsight	N
Check Point	Q
Stake Points	S
Staking List	Z
Inverse	B
Traverse / Intersect	C
Station / Offset	Y
Calculator	F
AutoMap Library	D
Figure List	L

Toggle GNSS Coordinates	G
Store Points	W
Delete Last Saved Point	Disabled
 Point Database	P
Add Comment	X
Raw File Viewer	U
COGO History	V
Menu Home	H
Map Data Layers	Backspace
SIP Enable/Disable	Disabled
EDM Mode 1	1
EDM Mode 2	2
EDM Mode 3	Disabled
EDM Mode 4	Disabled
EDM Mode 5	Disabled
EDM Mode 6	Disabled
EDM Mode 7	Disabled
EDM Mode 8	Disabled
Prism Search	Disabled
Prism Track	Disabled
Prism ATR	Disabled
Laser Pointer	Disabled
Guide Lights	Disabled
Robot Joystick	Disabled

Language Selection

[Main Menu](#) | [Settings](#) | [Language Selection](#)

This screen will allow the user to specify what language is to be used at first launching of the program. After the first run and selection, it will default to that language automatically. **Note:** The Language Selection screen appears after installation is completed when the program is first launched or the user can go into the Settings menu and choose Language Selection to switch to a different one is desired.



FieldGenius also allows the user to import in a Language Resource file (res*.dll) by scrolling down to the bottom of the list and selecting the button "Select a Language Resource File"

AutoMap Library

Please see the [AutoMap Library](#) topic for details.

GroupCode Editor

Pre-defined groups are included with the default installation consisting of codes from the default AutoMap library. Default Groups are stored in the Settings.xml file, and those default groups will automatically be included when a new Project is created. There are two ways to create and edit Groups.

[Main Menu](#) | [Settings](#) | [GroupCode Editor](#)



From within the **GroupCode** Measure Mode:

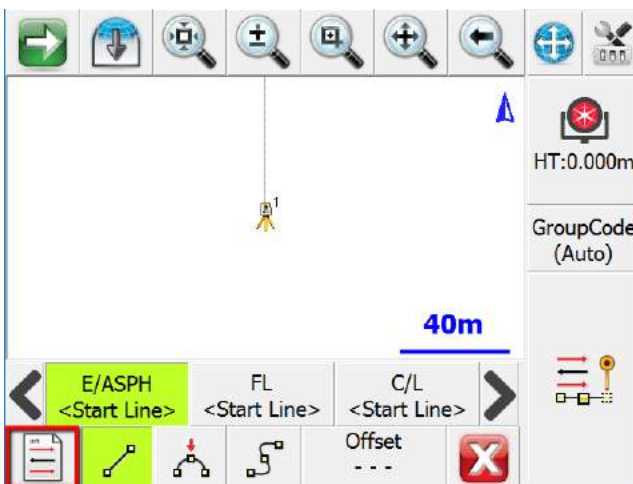

The editor shows the active group and the codes defined within the group. Toggles and options are also set from within the editor:

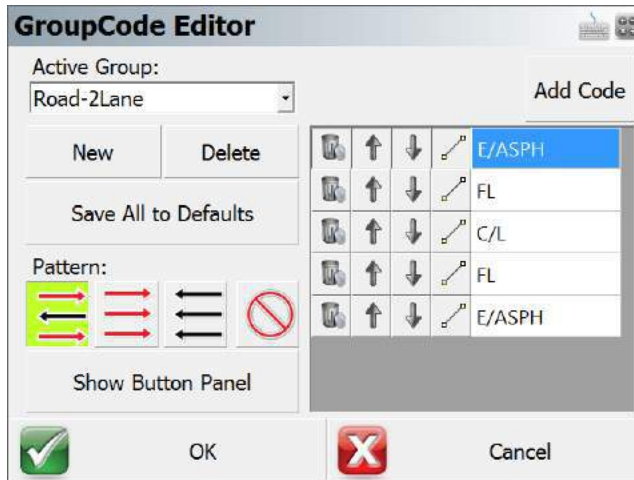

Creating a New Group

Pick "New" to create a new group. A dialog opens to enter a name for the group.

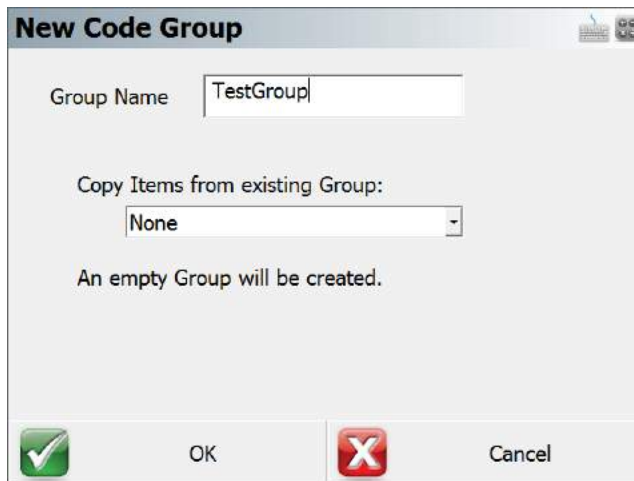

Optionally copy the group items from another group in the current Project, or from the defaults stored in the Settings.xml file.

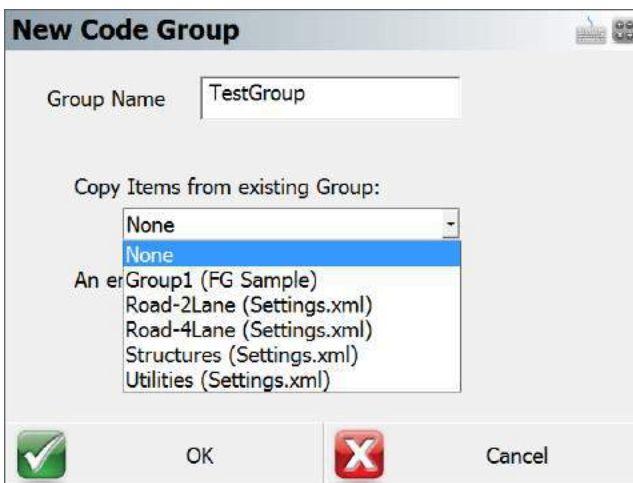

Deleting a Group

Pick “Delete” to delete the active group. A confirmation dialog is displayed.

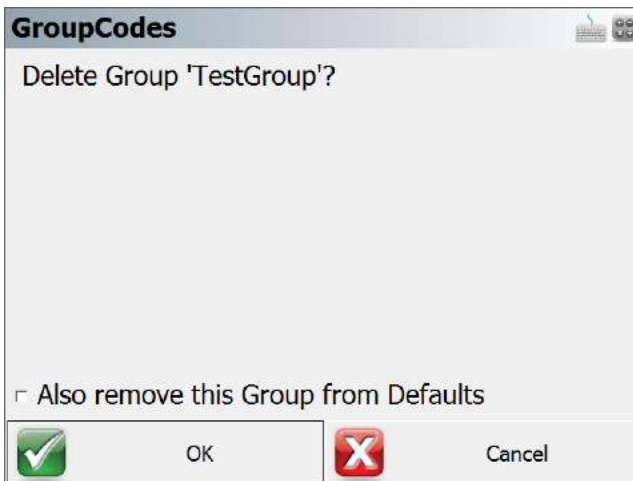

Saving a Group to Defaults

Pick “Save All to Defaults” to copy all groups from the current Project to the Settings.xml file.

Setting an Automation Pattern

Pick the icon of the Automation Pattern to set for the group. The pattern controls the automatic setting of the next active code after a measurement has been stored. The options are “Zig-Zag”, “Left to Right”, “Right to Left” and “None”.



- Zig-Zag pattern will cycle through the group, then reverse back through, and repeat
- Left to Right pattern will cycle through the group in a forward direction
- Right to Left pattern will cycle through the group in a reversed direction
- None pattern does not auto-select the next code, it is up to the user to pick the code

Adding Codes to a Group

Pick “Add Code” to enter a new code to the group. A dialog opens to enter the code (or pick from the AutoMap list) and to set the linework toggle for the code.

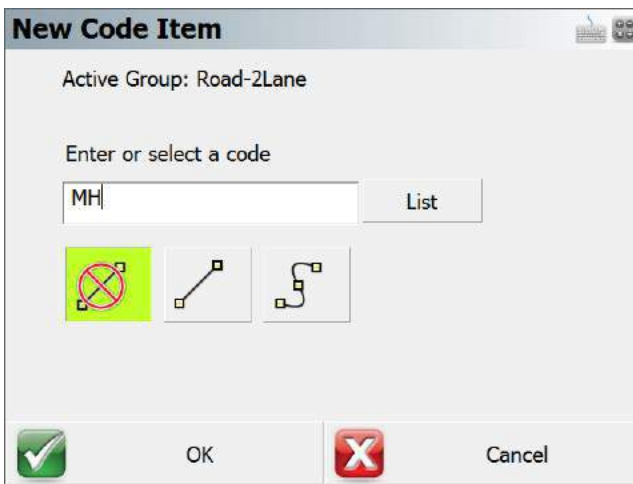

Deleting a Code from a Group

Pick the Delete icon of the code row to remove a code from the list.

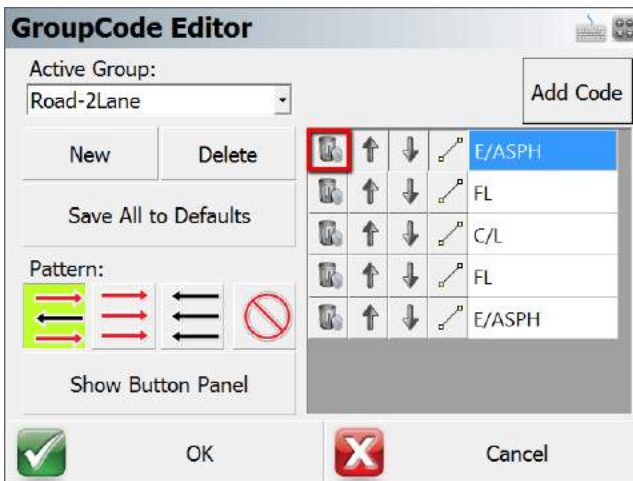

A confirmation dialog appears.

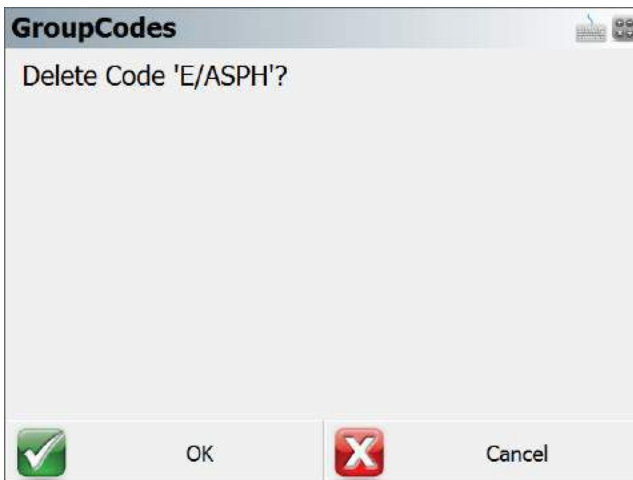

Modify Code Order

Use the Up and Down arrows to move the Code up or down within the group.



Toggle Linework

Use the Line Toggle to switch the current linework toggle for the code. The options of “straight line”, “second point on 3-point arc”, “spline”, and “none” are cycled.



Toggle Display

The “Show Button Panel” option can set the display mode to a grid of 12 buttons with the codes of the group. The default display mode is the code carousel with the Map Screen visible.

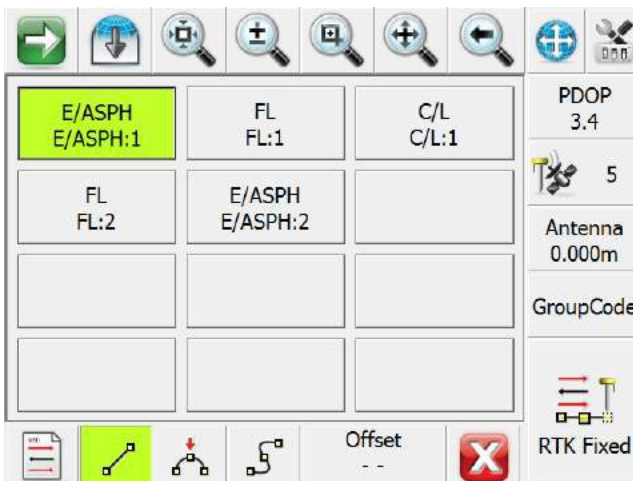

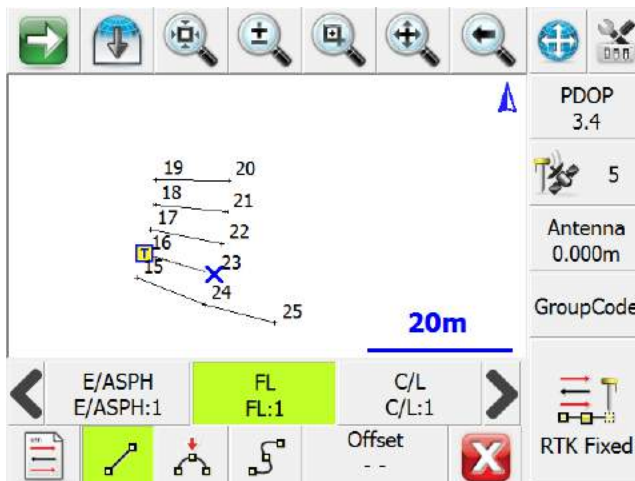

Feature List Editor

[Main Menu](#) | [Settings](#) | [Feature List Editor](#)

The Feature List Editor program is installed with the Tablet/PC version of the program and can be launched from the Settings menu. This program can be used to create feature list files for GIS attribute collection. Please visit the [MicroSurvey Helpdesk](#) for movies and more information.

Project Information

[Main Menu](#) | [Settings](#) | [Project Information](#)

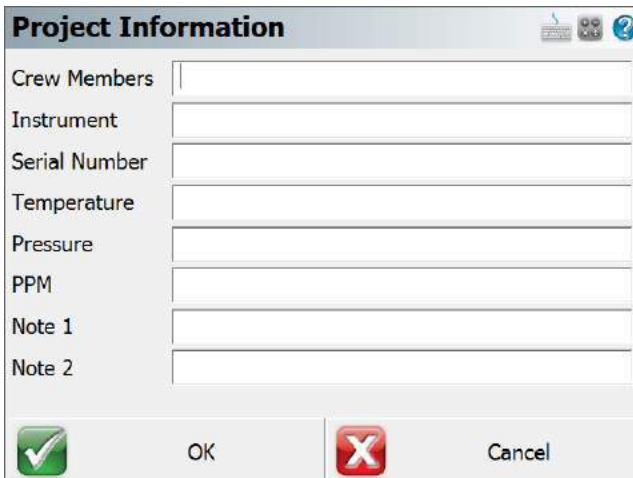

Project Information

Crew Members

Instrument

Serial Number



Temperature

Pressure

PPM

Note 1

Note 2

 OK  Cancel

Use this option to record job information about your Project.

Tap **OK** to save your information to the raw file, or **Cancel** to exit without saving your changes. Each entry field can accept up to 64 characters.

About FieldGenius

[Main Menu](#) | [Settings](#) | [About](#)

Use this to display information about the FieldGenius version you have installed or view what modules you have registered.

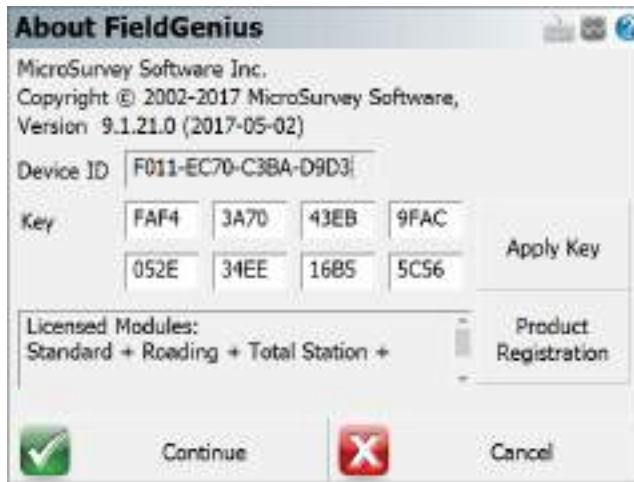

You will also see your Device ID and a series of fields where you can input the Key Code you received from MicroSurvey.

You will see an area that will show you the status of your license, including any modules that you currently have licensed. If you want to use FieldGenius in demo mode, press the **Run Demo Mode** button.

Please refer to the [Registration & Demo Mode](#) topic for further information.

Measure Modes (Total Station)

Main Menu or Instrument Toolbar | Measure Modes

These are commands built into FieldGenius that will help you measure and map your points. The desired method must be selected before you begin a measurement.

For a faster way to get to this screen, you can also press the Measure Mode button which is located on the [instrument toolbar](#).

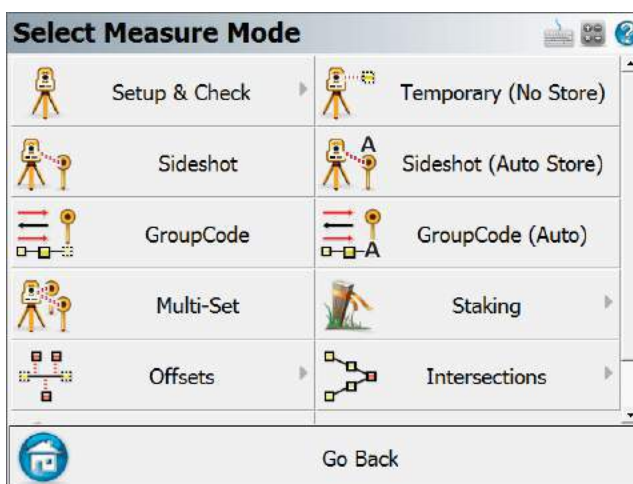
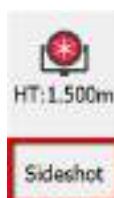

Use the vertical scroll bar along the side to access additional Measure Modes if they cannot all fit on screen at the same time.

Note: Several of these Measure Modes will not be available until you have completed a setup.

Setup and Check

[Backsight by 1 Point or Direction](#)

Use this to define an instrument setup. Please see the [Backsight Method](#) topic for more information.

Backsight by Multiple Points or Directions

Use this to define an instrument setup. Please see the [Backsight Method](#) topic for more information.

Resection

This will start the multiple point resection routine to allow you to determine your current instrument position by measuring to known points. Please see the [Resection](#) topic for more information.

Observe Benchmark

Use this to check your current setup elevation, or compute a new one based on a known elevation. Please see the [Measure Benchmark](#) topic for more information.

Check Backsight

Use this to compare your backsight to your previously measured values. Please see the [Check Backsight](#) topic for more information.

Check Point

Use this to display a check measurement to an existing point in your Project. Please see the [Check Point](#) topic for more information.

Temporary (No Store)

This will allow you to take a measurement without storing it. Please see the [Temporary \(No Store\)](#) topic for more information.

Sideshot

This mode allows you to measure a point. After the measurement, it will allow you to review your measurement data and allow you to make changes to the point ID and description before it is stored. Please see the [Sideshot](#) topic for more information.

Sideshot (Auto Store)

This mode allows you to measure a point using the next available point id, and the description and line toggles specified on the main map screen. Using this is a very fast method for recording your measurements. Please see the [Sideshot \(Auto Store\)](#) topic for more information.

GroupCode

This mode allows you to set up a Group of Codes that have a common theme or purpose, and is ideal to increase productivity for repetitive feature collection. Please see the [GroupCode](#) topic for more information.

GroupCode (Auto)

The GroupCode mode with automatic point storing using the next available Point ID.

Multi-Set

This will start the multi-set routine that will help you collect repeat observations to your backsight and a new foresight point. Please see the [Multi-Set](#) topic for more information.

Staking

Please see the [Staking Menu](#) topic for more information.

Offsets

Distance Offset

This will start the distance offset routine. Please see the [Distance Offset](#) topic for more information.

Horizontal Angle Offset

This will start the angle offset routine. Please see the [Horizontal Angle Offset](#) topic for more information.

Vertical Angle Offset

This will allow you to compute the height of an object. Please see the [Vertical Angle Offset](#) topic for more information.

Line - Distance Offset

This allows you to measure two points to define a baseline, then manually enter measured distances. These distances will be used to compute a new point based on the baseline. Please see the [Line - Distance Offset](#) topic for more information.

Add Invert

Use this to open the invert toolbar. You will then be able to record invert measurements. Please see the [Add Invert](#) topic for more information.

Intersections

Two Line Intersection

This allows you to measure two baselines and FieldGenius will compute the intersection point. Please see the [Two Line Intersection](#) topic for more information.

Line - Angle Intersection

This allows you to measure two points to define a baseline, measure an angle, and FieldGenius will compute the intersection point. Please see the [Line - Angle Intersection](#) topic for more information.

Line - Perpendicular Point

This allows you to measure two points to define a baseline, then you can select an existing point which will be used to compute a perpendicular intersection. Please see the [Line - Perpendicular Point](#) topic for more information.

Trilateration

This will allow you to compute new points by observing their distances from two known existing points. Please see the [Trilateration](#) topic for more information.

Vertical Plane Projection

This will allow you to compute points on a user defined vertical plane. Please see the [Vertical Plane Projection](#) topic for more information.

Point Scanning

Use this to activate Point Scanning with your motorized reflectorless instrument. Please see the [Point Scanning](#) topic for more information.

Manual

Manual Distance

This will record a HA and VA for a shot, but the user can manually enter the distance. Please see the [Manual Distance](#) topic for more information.

Manual Entry

This will allow you to manually enter in a shot including HA, VA and SD. Please see the [Manual Entry](#) topic for more information

Setup & Check

Backsight by 1 Point or Direction

[Main Menu or Instrument Toolbar](#) | [Measure Modes](#) | [Setup & Check](#) | [Backsight by 1 Point or Direction](#)

Use this command to specify the instrument location and orientation. You will be asked to specify the point your instrument is occupying, an instrument height and if you will be assuming a backsight direction or sighting an existing point. After you have established your setup and backsight, FieldGenius will graphically show you your setup points.



Occupied Point Location

Backsight Point Location

Backsight Method: Direction

With the backsight method set to Direction you will be able to specify the point you want to setup on and specify a backsight direction.

When you go to measure you have the option of recording an angle and distance to the backsight, or the option of just recording an angle. If a distance is measured to the backsight you will have the option of storing a point for the backsight after you press the measure button.

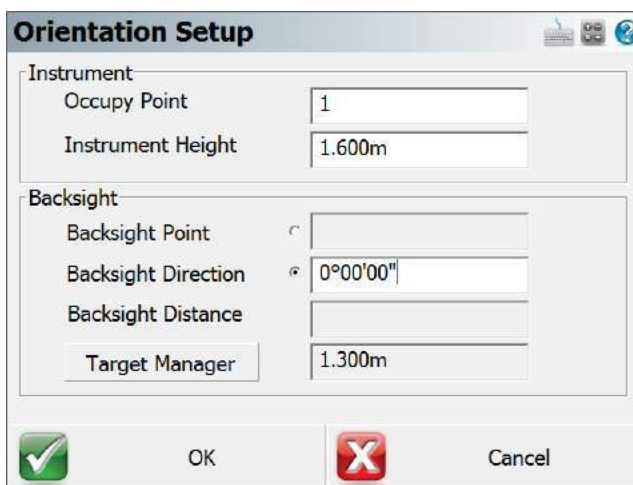

Orientation Setup	
Instrument	
Occupy Point	1
Instrument Height	1.600m
Backsight	
Backsight Point	
Backsight Direction	0°00'00"
Backsight Distance	
Target Manager	1.300m

Occupy Point

Type in an existing point number, or double tap in this field to open the keypad or to select a point from the map. You will be able to create a new point, pick one from a list, or pick one from your drawing.

Instrument Height

Use this to enter your current instrument height.

Backsight Direction

Use this to specify the direction that will be used by FieldGenius. You can enter an azimuth or a quadrant bearing.

Target Height

Use this to enter your current target height.

Backsight Method: Point

Use this method to specify the points that will be used for the current instrument location and backsight.

Orientation Setup	
Instrument	
Occupy Point	1
Instrument Height	1.600m
Backsight	
Backsight Point	2
Backsight Direction	0°00'00"
Backsight Distance	100.000m
Target Manager	1.300m
	OK
	Cancel

Occupy Point

Type in an existing point number, or double tap in this field to open the keypad or to select a point from the map. You will be able to create a new point, pick one from a list, or pick one from your drawing.

Instrument Height

Use this to enter your current instrument height.

Backsight Point

Type in an existing point number, or double tap in this field to open the keypad or to select a point from the map. You will be able to create a new point, pick one from a list, or pick one from your drawing.

Backsight Direction & Distance

When you enter in your points FieldGenius will display the inversed horizontal distance and direction between the points you entered.

Target Height

Use this to enter your current target height.

Measuring to the Backsight

Once you've established the backsight method, entered your points and instrument height you can move on to the next step by pressing the **Observe Backsight** button. You will be taken back to the map view where you will see the graphical position of your setup and backsight points. There are a few things you should take note of:

1. You can always tell what mode you're in by the "mode" text that appears near the top of your drawing. Since you're using the occupy point command you will see "Observe Backsight" near the top of the map area.
2. You have two measure modes available to you on the instrument toolbar. You can measure an angle and distance to the backsight, or measure only your current plate reading without measuring a distance. The two options are described in more detail in the [Backsight Measure Mode](#) topic.
3. You can cancel the setup by pressing the Measure Mode button and choosing "Cancel Backsight"
4. While in the backsight mode, you can use any of the controls from the information and display toolbar.
5. You can set the height of target by using the HT button on the instrument toolbar.
6. When you're ready to measure to the backsight, press the Measure button on the instrument toolbar.

Backsight Summary

After you have taken your measurement you will see a summary of your shot. From this screen you can choose to accept the shot or re-shoot it. You can also specify if you want the plate reading set to zero or a specific azimuth (if this is supported on your instrument). For more information see the [Backsight Summary](#) topic.

Backsight Measure Modes

[Instrument Toolbar | Measure Modes Button](#)



When shooting to your backsight you have two options available and they can be accessed from the [instrument toolbar](#) using the Measure Mode button. The measure modes available are described as follows:

Angle & Distance

Specifying this will require you to measure a distance to the backsight either to a prism or reflectorless. It will also record the current plate reading on the instrument. Both the measure distance and plate reading will be used as the backsight reading in the raw file.

Angle Only

Specifying this will not require you to measure a distance to the backsight. All that will be recorded is the current plate reading on the instrument and this reading will be used as the backsight reading in the raw file.

Cancel Backsight

Use this to cancel your current backsight and occupy point command.

Backsight Summary

After you have taken your measurement you will see a summary of your shot. From this screen you can choose to accept the shot or measure again. You can also specify if you want the plate reading set to zero or a specific azimuth.

Orientation Result

Backsight Observations
 HA 0°00'00" VA 90°00'00"
 SD 106.759m HD 106.759m
 HI 0.000m HT 0.000m

Backsight Errors

Calc Horz Dist	106.745m	Error	0.015m
Calc Elev	393.413m	Error	0.535m

Reciprocate Traverse

Plate Setting
 [Do Not Modify] 0°00'00"

Accept

Backsight Observations and Errors

If you specified the point backsight method you will see a comparison between what you measured and the theoretical inverse. If you used the measure angle only mode, or defined a backsight direction you will not see a comparison as there isn't enough information available to compute the inverse.

Reciprocate Traverse

This option will only be available if the "Traverse Reciprocate" option in [Options](#) is turned on. By default, it is turned off.

This option can only be used if the point being occupied was previously measured and stored as a TR shot. If it was stored as a SS shot then this will be grayed out.

If this option is turned on then when you measure the backsight, FieldGenius will compute a new elevation for the point being occupied, based on:

1. The measured elevation of the occupy point, based on its previously recorded TR traverse measurement.
2. The computed elevation of the occupy point, based on the backsight observation and the elevation of the backsight point.

These two elevations for the occupy point are averaged together, and a new traverse observation is computed for the occupy point, which will result in the occupy point having this new averaged elevation. This computed observation is written to the raw file as a new TR record, overriding the previous TR record to the occupy point.

Plate Setting

If your instrument supports uploading of angles, the **Set To Direction** and **Set To Zero** options will be available to you. If it doesn't support this then these options will be grayed out. These functions can be used to help you set your backsight plate angles on your instrument.

Do Not Modify

With this option selected, the plate reading on the instrument will not be modified by FieldGenius. You will see the current plate reading displayed beside the pull-down list.

Set To Direction

If your instrument supports uploading of angles, the **Set To Direction** option will be available to you. If it doesn't support this it will be grayed out. Beside the pull-down list you will see the direction field which will contain a value based on two factors:

1. If you specified a points for the occupy and backsight points, you will see the computed (inversed) direction.
2. If you specified a setup point and a direction to the backsight, you will see the direction that you previously entered.

When you press the **Accept** button, FieldGenius will upload the angle to your instrument and set it as the current plate reading. When you accept the setup, this value will be used as the backsight plate reading in the raw file.

Set To Zero

If your instrument supports uploading of angles, the **Set To Zero** option will be available to you. If it doesn't support this it will be grayed out. You will see a direction value of zero displayed beside the pull-down list.

When you press the **Accept** button, FieldGenius will upload and set your circle plate reading to zero. When you accept the setup, this value will be used as the backsight plate reading in the raw file.

Finishing the Setup Routine

Accept

Once you've reviewed your backsight information you can complete it by pressing the **Accept** button. This will write a record to the raw file and exit the setup routine.

If you specified the direction backsight method you will be prompted to "Store the point observed at the backsight?" Press **Yes** to store a point for the backsight, or **No** to complete the setup without creating a new point at the backsight.

Observe Again

If you're not satisfied with the results or made a mistake you can re-shoot the backsight by using this button. Doing so will take you back to the main display where you can take another shot on the backsight.

Occupy Point Raw Records

When you accept your occupy point, points will be stored in the database for the setup and backsight if applicable. Also, the following records will be written to the raw file:

```
SP,PN2,N 918.0848,E 1057.3576,ELO.0000,--
--Orientation
LS,HI5.000,HR5.000
OC,OP1,N 1000.0000,E 1000.0000,ELO.0000,--
BK,OP1,BP2,BS145.00000,BC0.00000
BR,OP1,BP2,AR145.00000,ZE90.00000,SD100.00000
-- Orientation Notes (several comment lines)
```

If the "Reciprocate Traverse" option was used, then the following records will be written to the raw file:

```
TR,OP1,FP3,AR45.00000,ZE90.00000,SD100.00000,-- (Note: this is the pre-
viously measured record, not part of the occupy routine)
--Reciprocate Traverse
LS,HI5.000,HR5.000
BK,OP1,BP2,BS0.00000,BC0.00000
TR,OP1,FP3,AR45.00000,ZE90.00150,SD100.0000,--
--Orientation
LS,HI5.000,HR5.000
OC,OP3,N 1070.7107,E 1070.7107,EL99.992,--
BK,OP3,BP1,BS225.00000,BC0.00000
BR,OP3,BP1,AR0.00000,ZE89.59300,SD100.01000
-- Orientation Notes (several comment lines)
```

Multiple Backsight

[Main Menu or Instrument Toolbar](#) | [Measure Modes](#) | [Setup & Check](#) | [Backsight by Multiple Points or Directions](#)

Multiple Backsight routine allows you to use multiple known control points to calculate a more accurate backsight orientation.

Backsight by Multiple Points or Directions

Point	Backsight	Northing	Easting
2	<input checked="" type="checkbox"/>	100.000m	100.000m
3	<input type="checkbox"/>	100.000m	200.000m
4	<input type="checkbox"/>	200.000m	200.000m

Occupy Point

Your instrument location or Occupy Point can be entered here. Double click the empty will show a drop-down list. You can then select the point from Map, List, or create a New point.

Instrument Height

Enter the height of your instrument set up, it will be used in the calculation.

Control Points Table

You can click the "Add" button to select backsight points, a minimum of 2 points are required for calculation.

You can use the second column to select a desired backsight point, unchecked backsight points will be used to improve the accuracy of the selected one.

Multiple Backsight Results

Multiple Backsight Results

Instrument
 Occupy Point
 Instrument Height

Point	Use	Azimuth Offset	Offset Residual
2	<input checked="" type="checkbox"/>	359°21'23"	0°27'21"
3	<input checked="" type="checkbox"/>	0°06'03"	-0°17'19"
4	<input checked="" type="checkbox"/>	0°08'37"	-0°19'52"

Observe Again

Azimuth Offset RMS

OK **Cancel**

After taking measurements for each control points entered, Multiple Backsight results screen will show up to display calculated results and allow you to refine Azimuth Offset base on Offset Residual values.

Control Points Table

- "Point" column - shows the Point ID for each control points measured
- "Use" column - allows you to toggle if the selected control point will be used in the calculation or not.
- "Azimuth Offset" column - shows individual azimuth offset value for each control point.
- "Offset Residual" column - shows individual offset residual value, this value can be used to access the accuracy of each control point.
- "HA Observed" column - shows the measured horizontal angle.
- "HD Observed" column - shows the measured horizontal distance.
- "HD Difference" column - shows the difference in horizontal distance.

Observe Again

This button allows you to re-measure the selected control point if the residual offset value is greater than expected.

Azimuth Offset

This is calculated Azimuth for your improved backsight direction. You can adjust this value by selecting desired control points from the above table. The Offset Residual column can be used to assess the quality of each control point.

RMS

This is Root Mean Square (RMS) value for all selected Offset Residuals.

Once you are satisfied with the result, click 'OK' to "Backsight Summary" on page 171

Resection

[Main Menu or Instrument Toolbar](#) | [Measure Modes](#) | [Setup & Check](#) | [Resection](#)

FieldGenius has a multi-point resection routine that can be used to compute a point for a setup. It will use a least squares solution to determine the coordinates from the measurements you make to your points. The goal at the end of a resection is to compute the unknown coordinates of the instrument's current location based on measurements made to other known points in the Project.

- As a minimum you need to have two points to resect off.
- You can shoot the resection point in the direct or reverse face.
- You can take multiple shots to the same resection point.
- There is no limit to the amount of points you can resect off.
- When you store your resection point, an occupy record will be created for you automatically.

Specify the Resection Reference Points

First Shot

When you start the command you will see the reference point toolbar. Specify your instrument height and select a reference point to measure. After you select a point, you can press the **Measure** button to record a shot.

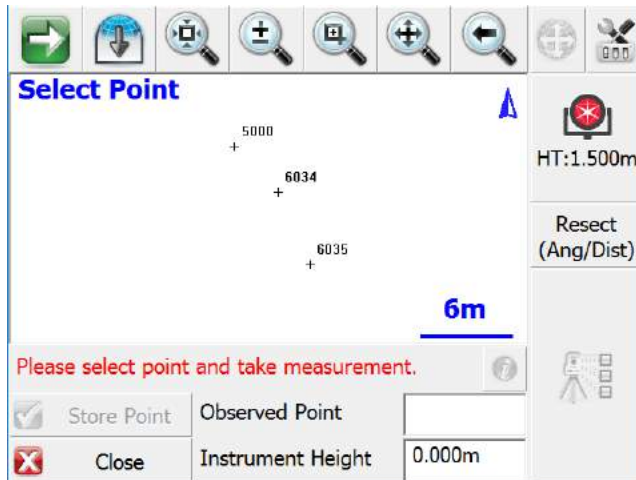

Second Shot

To record the second shot, simply select it from the map screen, then press the **Measure** button. A minimum of two points are needed to compute a position for the instrument, but you can shoot more points if needed to increase the accuracy of the instrument position. The estimated accuracy of the instrument location will be displayed for you on the toolbar. If the estimated error is within your own tolerances, then you can go ahead and store the point by pressing the **Store Point** button. All successful solutions will be displayed with green text starting with the characters *StdDev*.

Press the **Close** button to cancel out of the routine. You may need to do this if the solution does not converge, and you need to restart the routine.

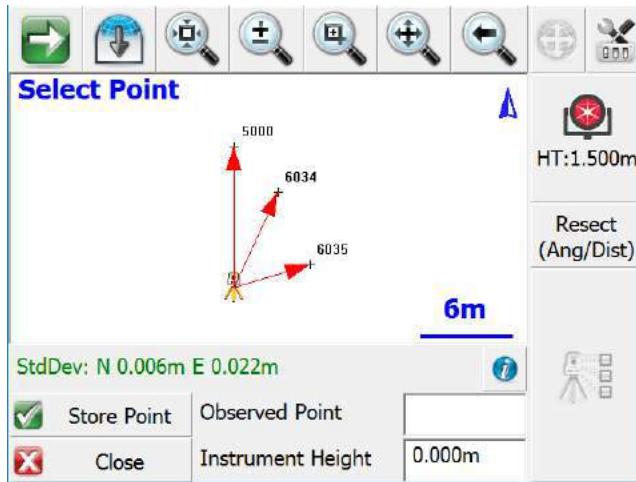

Three or More Shots

If you have more points to reference to you can continue measuring them using the same process as you did when you shot the second point. As you record more points you should notice that the standard deviations for the northing and easting will begin to get smaller.

Standard Deviation

This is the computed precision for the overall geometry of the resection. Small errors indicate that the measured data "fits" very well with the geometry defined by the known points.

Large errors can indicate that bad measurements were recorded, either due to careless measurement practices such as not holding the prism pole straight or not carefully sighting the prism. Large errors can also happen if the geometry defined by the known points, is not "in the same place" as it was when the points were previously measured.

Please note that while the Standard Deviation relates to the quality of your resection, it is possible to have a low StdDev yet still have a high positional error. As such, it is important that you also look at the angle and distance errors shown in the Information screen when considering the overall accuracy of your resection.

Information (Horizontal and Vertical Filters)



You can enter this screen by pressing the **Information** button on the top right corner of the reference point toolbar. When you do, you will see a detailed summary of the measurements.

Resection					
Valid Solution: StdDev: N 0.006m E 0.022m					
Point	Backsight	Use H	Use V	HA Error	HD Err
5000	<input checked="" type="checkbox"/>	<input checked="" type="checkbox"/>	<input checked="" type="checkbox"/>		-0.034
6034	<input type="checkbox"/>	<input checked="" type="checkbox"/>	<input checked="" type="checkbox"/>	-0°00'12"	-0.041
6035	<input type="checkbox"/>	<input checked="" type="checkbox"/>	<input checked="" type="checkbox"/>	0°00'12"	-0.033

Close

You can determine how each shot to the reference points should be used to compute the resection point. By default each observation you make will be used to compute both the horizontal and vertical position of the resection solution, but you can override this by setting the **Use H** and **Use V** options for each measurement.

Use H	Use V	Result
✓	✓	This shot will be used to compute both the horizontal and vertical position.
✓	✗	This shot will be used to compute only the horizontal position.
✗	✓	This shot will be used to compute only the vertical position.
✗	✗	The shot will be ignored in the computation.

You can also select which observation is to be your backsight point.

HA Error

The horizontal angle error is computed as follows. Using the computed resection point and the measured horizontal angle, a theoretical direction is computed to the reference point. This direction is then compared to the direction measured (plate reading) and the difference is noted in the HA Err column.

HD Error

The horizontal distance error is computed as follows. An inverse is made between the resection point and the reference point. This inversed distance is then compared to the measured distance and the difference is noted in the HD Err column.

VD Error

The vertical distance error is computed as follows. Using the resection elevation, and the observation to the reference point, a new elevation is computed for the reference point. This computed elevation is then compared to the reference point's original elevation and the difference is noted in the VD column.

Resection Modes

At any time during the collection of your observations you can choose to shoot an **Angle & Distance** or **Angles Only** measurement. You can control this by pressing the Measure Modes button on the [instrument toolbar](#) after you have started your resection.

Store the Resection Point

When you're satisfied with the resection point you can store its new position by pressing the **Store Pnt** button. This will then display the store / edit screen.

Finally you will see the [backsight results](#) screen.

Orientation Result

Backsight Observations
HA 0°00'00\" VA 87°49'10\"
SD 9.194m HD 9.188m
HI 0.000m HT 1.500m

Backsight Errors
Calc Horz Dist 9.153m Error **0.034m**
Calc Elev 100.328m Error **0.003m**
 Reciprocate Traverse

Plate Setting
Do Not Modify 0°00'00\"

Accept Observe Again Cancel

The backsight point that will be stored will be based on which point you selected in the Information screen shown above, which by default is the first reference point you observed. You do not need to take another measurement to the backsight as it has the original measurement you made. At this point you can do the following:

- Confirm the instrument and target heights.
- Decide if you want to set the plate reading on the instrument to zero or an azimuth.
- Decide if you would like to sight it again and take another measurement.

If you're satisfied with the backsight, you can store it by pressing the **Accept** button. If you're setting a plate reading on the instrument, you need to make sure it is pointing at the backsight point prior to pressing the Accept button. For example, if you want to set zero on the backsight point, you need to make sure that the instrument is pointing at the backsight point.

Raw File Record

After you store the point, several records will be written to the raw file.

```
--Resection
SP,PN5000,N 1009.1534,E 1000.0000,EL100.3244,--
SP,PN6034,N 1006.1995,E 1002.8319,EL99.7321,--FS
SP,PN6035,N 1001.4706,E 1004.8775,EL99.7361,--FS
RS,PN5000,CR359.59590,ZE87.49010,SD9.1600
RS,PN6034,CR24.33000,ZE92.03450,SD6.8280
RS,PN6035,CR73.13080,ZE92.43050,SD5.1010
SP,PN6036,N 999.9998,E 999.9998,EL100.0011,--
OC,OP6036,N 999.9998,E 999.9998,EL100.0011,--
SP,PN5000,N 1009.1534,E 1000.0000,EL100.3244,--
BK,OP6036,BP5000,BS0.00039,BC0.00000
--Occupy Check
-- Observed Values: HA 0°00'00.0" VA 87°49'22.0" SD 9.160m HD 9.153m
-- Distance Calculated: 9.154m
-- Distance Error: -0.000m
-- BS Elevation: 100.324m
-- BS Elevation Error: 0.001m
```

Observe Benchmark

[Main Menu or Instrument Toolbar](#) | [Measure Modes](#) | [Setup & Check](#) | [Observe Benchmark](#)

Use this to check your current setup elevation or use it to establish an elevation for your setup. When you start the command you will be taken to the main interface and you will note that the Measure Mode will be set to **Benchmark**. If you need to cancel the operation you can do it by pressing the Measure Mode button and choose the **Cancel Benchmark** button.

When you're ready to record the shot press the **Measure** button on the instrument toolbar. You will then see the benchmark shot screen.

Benchmark Measurement

Benchmark Method
 Elevation Point

BM Elevation: 101.077m

BM Point

HI: 1.523m HT: 1.500m

New Occupy Elevation: 101.054m
Old Occupy Elevation: 101.090m
Elevation Difference: -0.036m

Set Elevation Cancel

Calculating an Elevation

Benchmark Method: Elevation

Use this option if you want to manually enter the know elevation for the point you're basing your shot on. The elevation you enter will be used to calculate the elevation of the current setup. The difference in the current and calculated elevations will be displayed towards the bottom of the screen. You can enter in your know elevation in the **BM Elevation** field.

Benchmark Method: Point

Use this option if you want to base the calculated elevation on an existing point in your project. The elevation of the point you choose will be used to calculate the elevation of the current setup. The difference in the current and calculated elevations will be displayed towards the bottom of the screen. You can choose your point by using the point chooser button.

HI

This is where you would enter your height of instrument. Note this value will be used to compute the new instrument elevation.

HT

This is where you would enter your height of target. Note this value will be used to compute the new instrument elevation.

Set Elevation

Pressing this button will update your current setup elevation with the one calculated by the Benchmark Shot routine. You will be asked to confirm that you want to update the elevation. Two records will be written to the raw file, a remote elevation (RE) and a store point (SP) record.

```
| RE,OP1,FE0.000,ZE90.00000,SD10.0000,--Remote elev  
| SP,PN1,N 5001.0000,E 4978.0000,ELO.0240,--
```

Cancel

This will exit the routine and not save any changes.

Check Backsight

[Main Menu or Instrument Toolbar](#) | [Measure Modes](#) | [Setup & Check](#) | [Check Backsight](#)

Use this to check your backsight. FieldGenius will compare your newly measured value to the one that was stored for your current setup. You will be able to review difference and optionally update your current setup with the new shot to the backsight.

When you start the command you will be taken back to the map screen and the Measure Mode will be set to **Check BS**. You have two measure modes available when taking a check shot to your backsight. Please see the [Backsight Measure Mode](#) topic for more information.

Check Backsight Summary

When you're ready to record the shot press the **Measure** button on the instrument toolbar. You will be presented with a screen that compares your measured values to the ones that were stored for the current backsight.

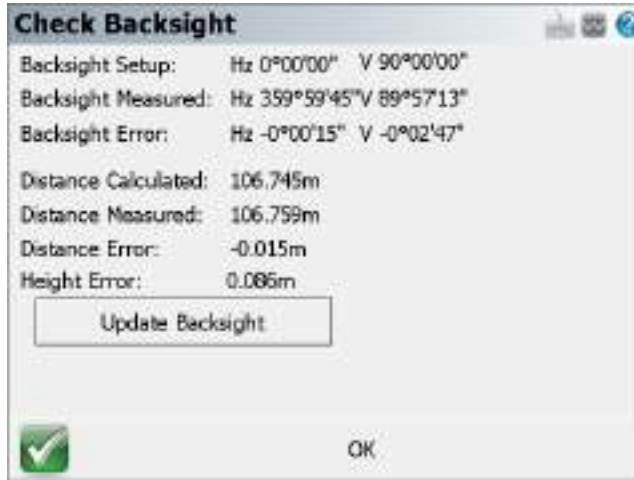

Update Backsight

Pressing this will create a record in the raw file updating your setup and backsight record with the shot information from your check shot. Several notes will also be written to the raw file summarizing your shot. When you choose to update the backsight, a new OC and BK record is saved as well as the shot information. You will also see the word (Updated) which indicates that the user selected the Update button.

```

OC,OP5,N 763.8748,E 1000.0000,EL0.0000,--
SP,PN1,N 1000.0000,E 1000.0000,EL100.0000,--start
BK,OP5,BP1,BS0.00000,BC0.00000
LS,HI0.000,HR5.000
--Backsight Check (Updated)
-- Observed Values: HA 0°00'00.0" VA 90°00'00.0" SD 163.12'
-- Backsight Setup: 0°00'00"
-- Backsight Measured: 0°00'00"
-- Backsight Error: 0°00'00"
-- Distance Calculated: 236.13'
-- Distance Measured: 163.12'
-- Distance Error: 73.01'
    
```

OK

Pressing this will exit the function and write several notes to the raw file summarizing your check shot.

```

--Backsight Check (Not Updated)
-- Observed Values: HA 0°00'00.0" VA 90°00'00.0" SD 236.10'
-- Backsight Setup: 0°00'00"
    
```

```

-- Backsight Measured: 0°00'00"
-- Backsight Error: 0°00'00"
-- Distance Calculated: 236.13'
-- Distance Measured: 236.10'
-- Distance Error: 0.03'

```

Check Point

[Main Menu or Instrument Toolbar](#) | [Measure Modes](#) | [Setup & Check](#) | [Check Point](#)

Use this to measure a check shot to an existing point. When you start the command you will see the point chooser appear where you can create a new point or pick an existing one from a list or from the screen. After you choose your point you will be ready to measure. You will note the Measure Mode will be set to **Check Pnt** and if you need to cancel the operation you can do it by pressing the Measure Mode button and choose to cancel it.

Check Point Summary

When you're ready to record the shot press the **Measure** button on the instrument toolbar. You will be presented with a screen that compares your measured values to the ones that were computed for the check shot point.

The screenshot shows a dialog box titled "Check Point" with the following data:

Check Point	
Identifier:	10
Description:	Nail
Delta Northing:	32.064m
Delta Easting:	63.019m
Delta Elevation:	-1.734m
Delta Horizontal:	70.707m
Observed Point	
Northing:	5523903.248m
Easting:	312325.458m
Elevation:	393.458m

At the bottom of the dialog, there are two buttons: "Store Point" (with a green checkmark icon) and "Close" (with a red X icon).

The deltas that are displayed are computed by subtracting the shot coordinates from the known coordinates. In other words if you add the deltas to the shot point coordinates you will end up at the known point.

Store Point

Pressing this will exit the function and write several notes to the raw file summarizing your check shot, and allow you to store the shot using the [Store/Edit Point](#) screen.

```
--Check Point
-- Check Point ID: 110
-- Check Point dNorthing: -4.59'
-- Check Point dEasting: -1.82'
-- Check Point dElevation: -4.96'
-- Check Point dHorizontal: 4.94'
-- Observed Values: HA 45°00'00.0" VA 90°00'00.0" SD 23.00' HR 5.00'
-- Observed Point Northing: 5016.26'
-- Observed Point Easting: 5016.26'
-- Observed Point Elevation: 95.00'
```

Close

This will exit the check shot function and not write anything to the raw file or storing a new point.

Temporary (No Store)

[Main Menu or Instrument Toolbar](#) | [Measure Modes](#) | [Temporary \(No Store\)](#)

The temporary mode will allow you to take a measurement with your instrument without storing a point or recording anything to the raw file. It also doesn't require you to have established a setup. It is the same as pressing the measure button on the instrument where all it does is report back to you the HA, ZA, SD, HD and VD.

When in this mode you will see the word **Temp** on the Measure Mode button.

No Setup Established

If you haven't established a setup and you use the temp mode, when you press the measure button you will see the results of your measurement.

Setup Established

If you have an instrument setup established when you use the temp mode and press the measure button you will see the measurement information as well as calculated coordinates in the observation toolbar. The coordinates will be based on the current setup and the reading from the temporary shot.

Note:

When measuring in temp mode, nothing will be recorded in the RAW file.

Sideshot

[Main Menu](#) or [Instrument Toolbar](#) | [Measure Modes](#) | [Sideshot](#)

If you like reviewing your shots prior to being stored in the database and raw file, then this is the mode you should use. When you press the measure button on the instrument toolbar, after the shot is measured you will see the store point screen prior to storing the point.

When you set this mode you will see the word **Sideshot** on the Measure Modes button.

When you complete the measurement using the measure button you will see the [Store/Edit Point](#) screen.

You can also confirm or change the Target Height used for this shot.

After reviewing the information you have three options to choose from:

Store As Side Shot

The default selection, will store the coordinate in the database and create a sideshot record (SS) in the raw file.

```
| SS,OP350,FP3,AR0.00000,ZE94.50090,SD13.2700,--<No Desc> |
```

Store As Traverse Shot

Select this option to store the coordinate in the database and create a traverse record (TR) in the raw file.

```
| TR,OP350,FP4,AR0.00000,ZE94.50080,SD13.2700,--<No Desc> |
```

Traverse records are needed if you want to compute a traverse closure. If your last shot from a setup is recorded as a traverse record, when you use the [occupy point](#) routine it will automatically advance you. This is commonly referred to as "leap frogging" your traverse.

Store As Averaged Point

Select this option to use the observation for [Point Averaging](#). If you set the Point ID to a value of an existing point and store as Side Shot or Traverse Shot, the option to enter Point Averaging will be presented.

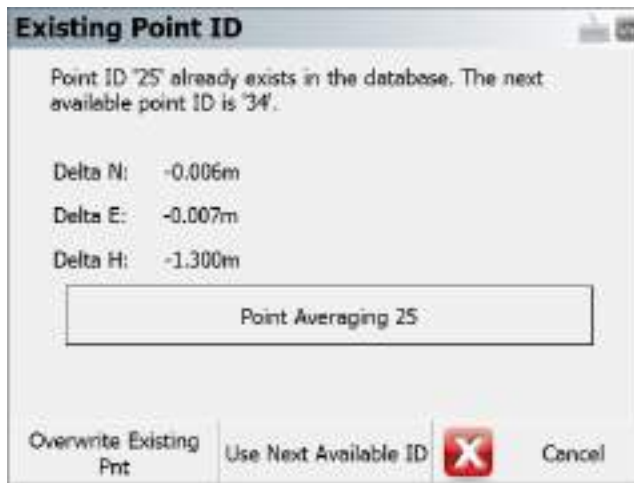

Store Pnt

Press this to store the point in the coordinate database and update the raw file.

Cancel

Press this to cancel the shot and not store anything.

Note: For more information on the other buttons found on this screen please read the [Store / Edit Points](#) topic.

Sideshot (Auto Store)

Main Menu or Instrument Toolbar | Measure Modes | Sideshot (Auto Store)

Use this when you have production in mind and you don't need to review your shots before they're recorded in the database and raw file. The Measure Mode allows you to press the measure button and it will store the point in the database and plot it in the drawing without asking you for any further information.

When in this mode you will see the words **Sideshot (Auto)** on the Measure Mode button.

It will use the following settings from the main interface when storing the point:

Next Point Number ID

The current point ID on the topo toolbar will be assigned to the point.

Description

The current description on the topo toolbar will be assigned to the point.

Height of Target

The current HT on the instrument toolbar will be used to compute the elevation of the point.

Note:

When measuring in the Auto Store mode, a SS record will be recorded in the raw file.

GroupCode

[Main Menu or Instrument Toolbar](#) | [Measure Modes](#) | [GroupCode](#)

Overview

GroupCode is a Measure Mode that allows the user to set up a Group of Codes that have a common theme or purpose, and is ideal to increase productivity for repetitive feature collection. GroupCode allows:

- Creating multiple groups of codes
- Setting a pattern to automate code selection for feature collection in a repetitive sequence (such as road cross sections)
- Linework toggles for each code in the group allowing linework to be automatically completed for each feature in the group as separate figures without any effort from the operator
- Switching between a carousel display combined with the Map screen, or a full-screen button panel with the codes in the group
- Fast switching between groups with settings retained for each group
- Fast switching between GroupCode and other Measure Modes and being able to resume collection within GroupCode with no additional steps

Operation Notes

For Total Station operation there are two Measure Modes:

- **GroupCode** – This mode displays the “Store Point” screen to allow editing of Advanced Options or to confirm Code and Linework options
- **GroupCode (Auto)** – This mode is similar to “Sideshot (Auto Store)” where the observation is automatically stored after the measurement is completed

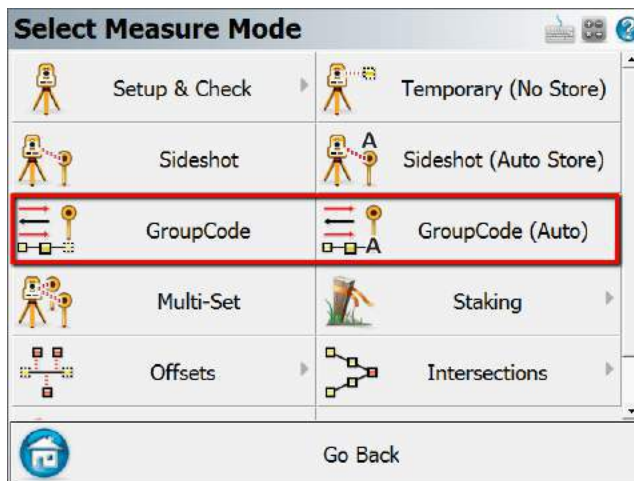

See the [GroupCode Editor](#) topic for information about setting up a group and changing its behaviours.

Workflow

The **GroupCode** feature is designed to allow fast measuring, and as such the automation of the code selection and multiple linework figures can reduce the task to a simple measurement button press. When no pattern is set, the user will manually need to select the next code to use, and line toggles will be necessary for drawing arcs.

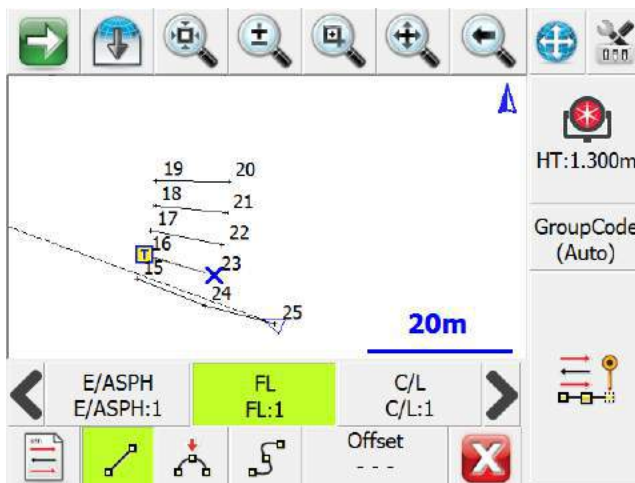

Entering Offsets

It is possible to pre-enter distance offsets that will be applied to the next measurement. The Offset button will display the offset directions that will be applied if the offsets are set. Forward/Back, Left/Right, and Up/Down.



The offset entry screen has numerous toggles that can be used to set the values:

- Offsets viewed from Instrument or Prism
- Forward Offset / Back Offset – Right Offset / Left Offset – Up Offset / Down Offset
- Field Value Resets, X next to field
- Apply offsets to All Measurements, Next Measurement Only, or None

GroupCode (Auto)

[Main Menu or Instrument Toolbar](#) | [Measure Modes](#) | [GroupCode \(Auto\)](#)

This Measure Mode automatically stores the observation with the selected code and the Next Point ID, otherwise identical to the main [GroupCode](#) feature.

Multi-Set

[Main Menu or Instrument Toolbar](#) | [Measure Modes](#) | [Multi-Set](#)

The Multiset routine in FieldGenius allows you to record angular sets in any order you want. You can also review your measurement's computed average and standard deviation.

Starting the MultiSet Routine

If you've previously measured to your backsight and are confident that it hasn't changed very much you can save some time by using the "**Apply the current orientation observation to the Multi-Set data set?**" option. If you select Yes, it will take the last backsight measurement you made and use it for the multiset session.

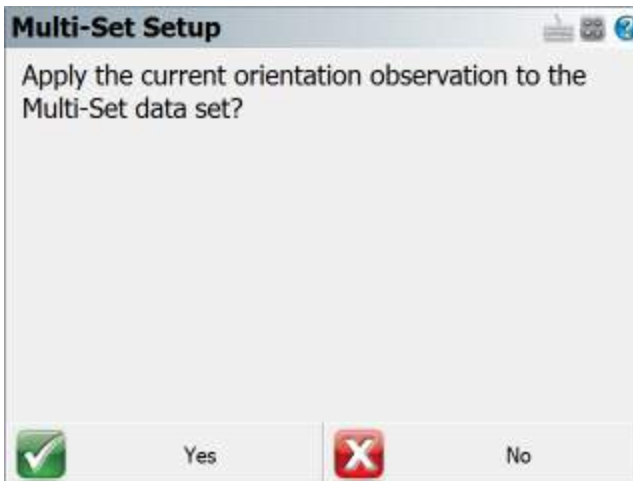

You will then see the [Setup Occupy Point](#) screen. If you've already established a setup, it will display the same information that you previously entered.

Press the **Continue Multi-Set** button to proceed to the Multi-Set Point List screen

Note:

Unlike the regular setup routine, you will not be required to immediately shoot your backsight.

Multi-Set Point List

Pnt	Type	Obs F1	Obs F2	Saved
2	BS	1	0	N/A

This is the control center for recording your sets. It will begin with a record for your backsight and your foresight measurements will be listed after it, in order that they are measured.

Pnt: This is the point number of the point you've measured for your backsight and foresight points. If you see the word "Bearing" this indicates that you assumed a backsight direction.

Type: This is the type of measurement that was measured. It will be either a BS (backsight) or FS (foresight) measurement.

Obs F1: This will list the total Face 1 (Direct) observations that were recorded for the point.

Obs F2: This will list the total Face 2 (Reverse) observations that were recorded for the point.

Saved: If the foresight measurement hasn't been saved you will see a red "X". measurements that have been saved will have a green "checkmark". Since your backsight readings are always to a known point or an assumed direction you will see N/A as there is nothing to save.

Measuring the Backsight

If you want to shoot your backsight, then do the following.

1. Select the first row which is the backsight record by tapping on it.
2. Press the **Measure** button to start the measurement process.
3. On the map screen confirm that you have selected the correct target height.
4. When you're ready to record the measurement press the **Measure** button on the instrument toolbar.
5. You will automatically see the multiset point list where you will see your measurement which will be indicated in the F1 or F2 field.

Reviewing the Backsight measurements

If you press the **Edit Set** button you will see a summary of the two measurements.

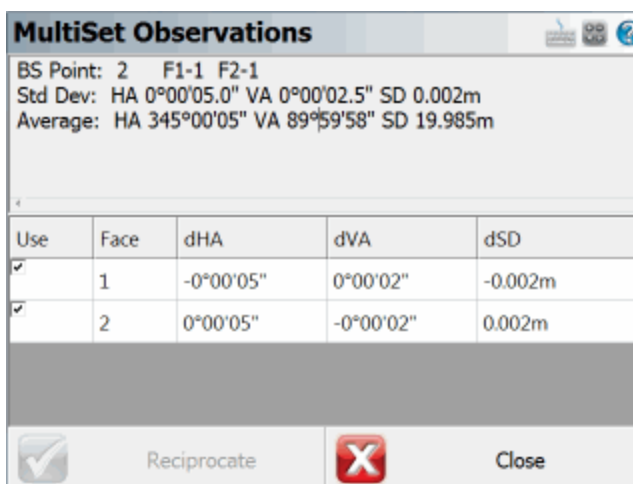

MultiSet Observations

BS Point: 2 F1-1 F2-1
 Std Dev: HA 0°00'05.0" VA 0°00'02.5" SD 0.002m
 Average: HA 345°00'05" VA 89°59'58" SD 19.985m

Use	Face	dHA	dVA	dSD
<input checked="" type="checkbox"/>	1	-0°00'05"	0°00'02"	-0.002m
<input checked="" type="checkbox"/>	2	0°00'05"	-0°00'02"	0.002m

Reciprocate Close

The summary will display the standard deviations for the averaged measurements as well as the computed average measurement. In the list you will see the delta difference between the measured measurement and the average. In our example the HA and VA on the face 1 measurement was larger than the average direction by 11 seconds.

By default all measurements will be used to compute the averaged position. However, you can decide what measurements you want to use to compute the averaged position by pressing the green checkmark icon. Doing so will switch it to a red "X" which will remove it from the computation.

Notes about measuring the Backsight:

When you first begin the multi-set routine, you are not required to shoot the backsight prior to measuring a foresight.

You are not required to have both a Face 1 and Face 2 reading recorded for the backsight. A measurement on either face will work, but it is common practice to record both.

Measuring a Foresight

To record a foresight measurement you first have to define a point number in the **Point ID** field towards the top of the multi-set point list. Press the **Next** button to display the next available point ID, or type in the Point ID you want to use. Then press the **Add** button to add the new Point ID into the Multi-Set Point List. After you add the new point number follow these steps to record the measurement.

1. Press the **Measure** button to start the measurement process.
2. On the map screen confirm that you have selected the correct target height.
3. When you're ready to record the measurement press the **Measure** button on the instrument toolbar.
4. You will automatically see the multiset point list where you will see your measurement to your foresight points. They will have the FS tag in the Type column.

Reviewing Foresight measurements

To review you foresight measurement for any point, simply highlight it in the list and press the **Edit Set** button.

MultiSet Observations

FS Point: 6 F1-1 F2-1
 Std Dev: HA 0°00'00.0" VA 0°00'03.5" SD 0.000m
 Average: HA 45°00'02" VA 89°59'59" SD 19.987m
 BS-FS Angle: 60°00'02"

Use	Face	dHA	dVA	dSD
<input checked="" type="checkbox"/>	1	-0°00'00"	-0°00'03"	0.000m
<input checked="" type="checkbox"/>	2	0°00'00"	0°00'03"	0.000m

Store Pnt Close

Towards the top you will see the foresight point you measurement to and a summary of the total face 1 and face 2 measurements recorded.

Next you will see the standard deviation that is computed using all the directions that have a green check mark.

Next is the averaged direction (plate reading) to the foresight point.

Finally, you will see the computed clockwise angle between the average backsight and foresight direction.

By default all measurements will be used to compute the averaged position. However, you can decide what measurements you want to use to compute the averaged position by pressing the green checkmark icon. Doing so will switch it to a red "X" which will remove it from the computation.

Once you're satisfied with your observations you can press the **Store Pnt** button which will take you to the Store and Edit screen. From here you can review the description and store it as either a SS or TR measurement.

Note: After you store your point, you will not be able to add anymore observations.

Auto Turn Sets

If you have a motorized instrument you will be able to have FieldGenius plunge your scope and turn back to the foresight or backsight for you.

Simply highlight the measurement you want to record an observation for, and select the **Auto Turn option** so the checkbox is checked.

Now when you press the **Measure** button the instrument will automatically plunge and turn back to your foresight point for you. You can then press the measure button on the instrument toolbar to record the measurement.

When you're using the Auto Turn option FieldGenius will first check to see how many Face 1 and Face 2 observations you have. It will automatically keep these numbers equal to one another. For example if you have 1 Face1 measurement, and 2 Face2 measurements, FieldGenius will automatically sight the foresight using Face 1.

Furthermore, if you're instrument is equipped with auto target recognition, you can use this feature in combination with the auto turn for greater productivity.

Multiset Measure Modes

At any time during the collection of your observations you can choose to shoot an angle & distance or angles only measurement. You can control this by pressing the Measure Modes button on the instrument toolbar.

If you're measuring to a foresight you need a minimum of 1 distance before you will be allowed to store it.

Raw File Record

When you store your multi-set points a point is created in the database as well as some records in the raw file.

```
--MultiSet (StdDev HA:0°00'03" VA:0°00'04" SD:0.005m)
OC,OP1,N 1000.0000,E 1000.0000,EL100.0000,--
SP,PN5,N 1015.5153,E 1000.0000,EL99.1936,--BS
BK,OP1,BP5,BS0.00000,BC359.59495
RB,OP1,BP5,AR0.00000,ZE93.42400,SD15.5479,HR5.000,--BS
RB,OP1,BP5,AR179.59390,ZE266.17420,SD15.5512,HR5.000,--BS
RF,OP1,FP8,AR45.52150,ZE92.03370,SD22.3917,HR5.000,--FS
RF,OP1,FP8,AR225.52100,ZE267.56580,SD22.4311,HR5.000,--FS
RF,OP1,FP8,AR225.52100,ZE267.57000,SD22.4311,HR5.000,--FS
RF,OP1,FP8,AR45.52180,ZE92.03350,SD22.3917,HR5.000,--FS
SS,OP1,FP8,AR45.52132,ZE92.03185,SD22.4114,--FS
```

For each foresight point you store; a OC record is created to indicate the setup information. Also a BK record will be written to record which point you specified for the backsight. An important thing to note here is that the BC value will be equal to the average backsight direction (plate reading) recorded for the backsight.

The Standard Deviations are written into the first comment record, and it will also display "Tolerance Exceeded" if applicable.

RB records are your accepted measurements to the backsight.

RF records are your accepted measurements to the foresight.

The last item will always be a SS or TR record. This is the averaged direction (plate reading) to the foresight point.

Staking

[Main Menu or Instrument Toolbar | Measure Modes | Staking](#)

See the [Staking](#) topic for more information.

Offsets

Distance Offset

[Main Menu or Instrument Toolbar | Measure Modes | Offsets | Distance Offset](#)

FieldGenius allows you to do a distance offset to specify an offset forward or backward along the line of sight, left or right, and vertically up or down.

When you choose distance offset command and take a measurement, you will see the following screen:

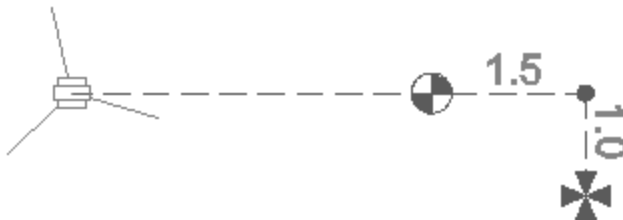

From this screen you can specify if the offsets are with respect to the instrument or prism.

- Offset buttons act as toggles, which allow you to easily define the direction the offset should be applied.
- A negative offset will automatically be converted to a positive value.
- The elevation of the point will be computed from your shot. This elevation will remain unchanged unless you specify a vertical offset.
- The distance is assumed to be horizontal.

Forward / Back Offset

Enter the offset distance from the shot position to the new position.

Right / Left Offset

Enter the perpendicular offset distance from the shot position to the new position.

Up / Down Offset

Enter the vertical offset distance from the shot position to the new position.

Store Point

After you have entered your offsets you can press the **Store Point** button to save the point

Raw Record

A sideshot (SS) record will be computed to represent the shot. The new SS record will use the original observation plus any offsets defined in the distance offset screen.

```
OF,AR55.00000,ZE90.00000,SD12.0000
OF,HD1.5000,--Horizontal Distance Offset
OF,LR1.0000,--Left / Right Offset
OF,VD0.0000,--Elevation Offset
SS,OP1,FP6028,AR59.14110,ZE90.00000,SD13.5370,--
```

Note: Offsets that are to the left, back or down will be stored in the raw file with a negative value.

Horizontal Angle Offset

[Main Menu or Instrument Toolbar](#) | [Measure Mode](#) | [Offsets](#) | [Horizontal Angle Offset](#)

FieldGenius includes a flexible angle offset routine. It allows you to shoot the angle and distance to a point that cannot be occupied by the rod. An example of where you would use this is if you wanted to record the center of a large object, such as a tree.

When you choose the Horizontal Angle Offset Measure Mode you will see the following screen.

Horizontal Angle Offset		
	Angle (Center)	Distance
HA		
VA		
SD		
HR		
HI		
No Solution		
Observe Angle	Observe Distance	Store Point
		 Cancel

Two observations are required: one to record the angle to the point of interest, and a second to measure a distance perpendicular to the point.

On this screen you determine what order you will make these two measurements. All you need to do is press either the **Observe Angle** or **Observe Distance** button.

Note: You can increase the size of the text shown in the grid by setting the Text Size option in the [Options screen](#).

Note: The Quick Measure Modes option in the [Options screen](#) will affect what happens when you press the Observe buttons when you are using the offset routines. If Quick Measure Modes is on, a measurement will automatically be taken. If it is off, the Observe button doesn't actually trigger your total station to take a measurement; it simply takes you to the map screen where you can press the measure button once you are ready to take the measurement.

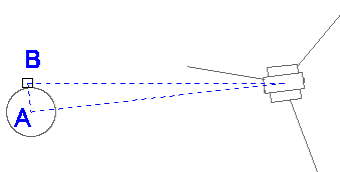

Angle (Center)

This will record the total station's horizontal angle. When measuring the angle, you should point the total station towards the center of the new point that will be created. This would be measurement "A" in the diagram shown above.

Note: You do not need to sight a prism to record the angle, simply sight the new point and press the **Observe Angle** button.

Distance

This will record a distance, measured to a prism which is located at the side of the object. You should try to locate the prism so that it is perpendicular to the center of the object and the line-of-sight from the total station. This is measurement "B" in the diagram shown above.

Note: The target height is important on this shot, because the new point will have the same elevation.

Storing the Shot

After you record your measurements you can store the new point by pressing the **Store Point** button.

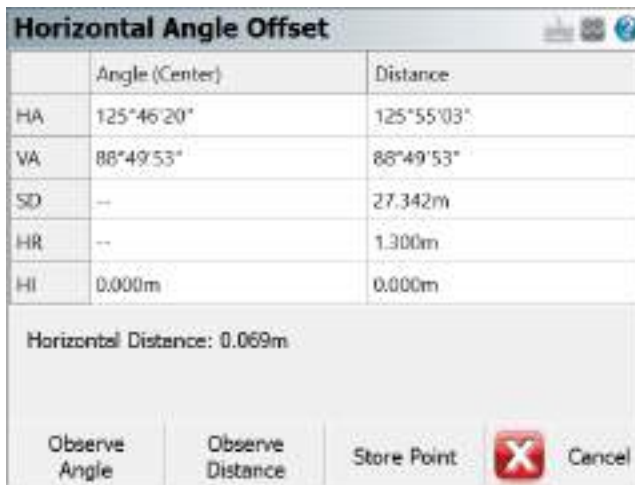

After you store the point, you can continue using the offset command to record additional points, or exit it by pressing the **Cancel** button.

Raw File Record

In the raw file the OF records represent the measurements that were made and the SS record is derived using the two OF records

```
| OF,AR94.49380,ZE88.41340,SD27.3163  
| OF,OL93.25450,--Right Angle Offset
```

| SS, OP1, FP23, AR93.25450, ZE88.41340, SD27.3081, --ROAD |

Vertical Angle Offset

Main Menu or Instrument Toolbar | Measure Modes | Offsets | Vertical Angle Offset

When you begin the vertical angle offset routine, you will see the following screen.

Two observations are required, one to record the top or bottom of the object, and a second to measure a distance that is directly underneath or above the new point.

Vertical Angle Offset		
	Angle (Height)	Distance
HA		
VA		
SD		
HR		
HI		
No Solution		
Observe Angle	Observe Distance	Store Point
		 Cancel

On this screen you determine what order you will make these two measurements. All you need to do is press either the **Observe Angle** or **Observe Distance** button.

Note: You can increase the size of the text shown in the grid by setting the Text Size option in the [Options screen](#).

Note: The Quick Measure Modes option in the [Options screen](#) will affect what happens when you press the Measure button when you are using the offset routines. If Quick Measure Modes is on, a measurement will automatically be taken. If it is off, the measure button doesn't actually trigger your total station to take a measurement; it simply takes you to the map screen where you can press the measure button once you are ready to take the measurement.

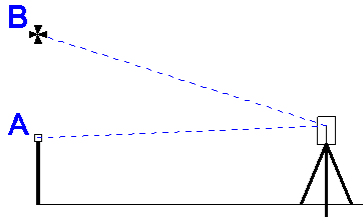

For example if point "B" was the bottom of an underpass, you could measure its height. Usually it is easier if you position the prism so it is directly beneath the point you want to shoot. You would then record a distance observation to this location which will also be the horizontal position for the new point. Then without turning your instrument, you could rotate the scope vertically so it is sighted on the bottom of the overpass. You could then record this observation which will be used to compute the elevation for the new point.

Once you've recorded these two measurements, you will be able to store the new position.

Storing the Shot

After you make your measurements, you will be able to store the new point. Press the **Store Point** button to store the point.

Raw File Record

In the raw file the OF records represent the measurements that were made. The SS record is the record that was used to compute the coordinate point for the angle offset and will be a compilation of your two shots.

```
| OF,AR52.53170,ZE91.12240,SD9.5616 |  
| OF,ZE91.12240,--Vert Angle Offset |  
| SS,OP1,FP2,AR52.53170,ZE91.12240,SD9.5616,--<No Desc> |
```

Line - Distance Offset

[Main Menu or Instrument Toolbar](#) | [Measure Modes](#) | [Offsets](#) | [Line - Distance Offset](#)

The line distance offset command is used to define two points that will be used to establish a reference line. Once the reference line is established you can then specify offsets along the reference line to the new point.

This is a very powerful offsetting tool that can be used in a lot of different situations.

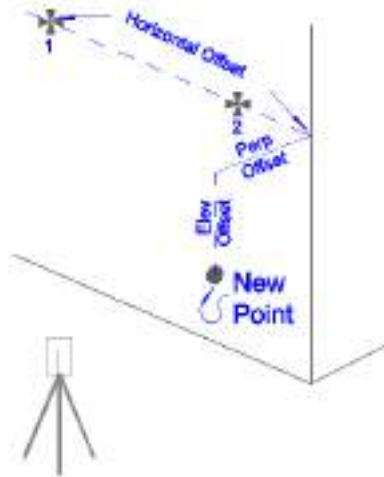

When you define your reference line, there are three types of offset that can be applied.

You can define a horizontal offset, a perpendicular offset and a vertical (elevation) offset. Each offset button is a toggle that allows you to toggle how the offset is to be applied in relation to the reference line.

When you define the offset direction, you can then enter in the value that you want to offset by.

If the horizontal offset remains set to zero, perpendicular or elevation offset will be applied in relation to point one on the reference line.

Offsets

Horizontal Offset

The horizontal offset can either be left or right of the first point on the reference line. From the total station's perspective, if the new point is to the right of point 1, then you would use the Horz Offset Right of Pnt 1. If it is to the left, then logically, it would be a left offset so you would use the Horz Offset Left of Pnt 1 setting.

Perpendicular Offset

The perpendicular offset is a horizontal distance applied perpendicular to the reference line. From the total station's perspective, when moving perpendicular from the reference line, if the new point ends up being closer to the total station, then you would set the perpendicular offset to Perp Offset Towards Inst. Alternatively, if the new point ends up being farther from the total station, then you would use the Perp Offset Away From Inst.

Elevation Offset

This is the vertical offset from the reference line to the new point. If the new point is above the reference line, then you would set this to Elev Offset Up. If the new point is below the reference line you would set it to Elev Offset Down.

Measure Points

When you start line angle offset command, you will see an empty list.

Highlight the row that you would like to make a measurement for and simply press the **Measure** button to begin the measuring process.

If you need to redo a measurement, simply highlight it in the list and press the measure button.

Notes:

1. The northing and easting values for the new point will be computed using the horizontal and perpendicular offsets defined by the user. These horizontal offset is referenced to point 1 on the reference line. The perpendicular offset is a perpendicular offset from the reference line.
2. The z value for the new point will be computed using the projected elevation along the reference line, plus or minus any elevation offsets defined by the user.



Note: You can increase the size of the text shown in the grid by setting the Text Size option in the [Options screen](#).

Store the Point

Once you've made your measurements that will be used to compute the intersection, you can press the **Store Point** button. This will store a point in the map screen, store a point in the database as well as record information to the raw file.

Raw File

Everything about the intersection is stored in the raw file.

```
--Line - Distance Offset
--HI0.000,HR0.000,AR357.09120,ZE81.12250,SD22.4114,--Pnt 1 of Line
--HI0.000,HR0.000,AR353.50430,ZE80.46590,SD21.3255,--Pnt 2 of Line
--Horizontal Offset: 2.000
--Perpendicular Offset: 0.000
--Elevation Offset: 0.000
SP,PN1018,N 123.5558,E 100.2931,EL103.4035,--EV2
```

Example

The top corner in a closet needs to be located, but it isn't visible from the total station.

So the user lays a hand tape on the floor, with the start of the tape located at the bottom corner of the closet, directly below the point that needs to be recorded. The direction of the tape is then laid out such that two measurements can be made on the tape.

Essentially, the tape now becomes the reference line. Two shots are taken, one at the 2 foot mark, and the other at the 5 foot mark.

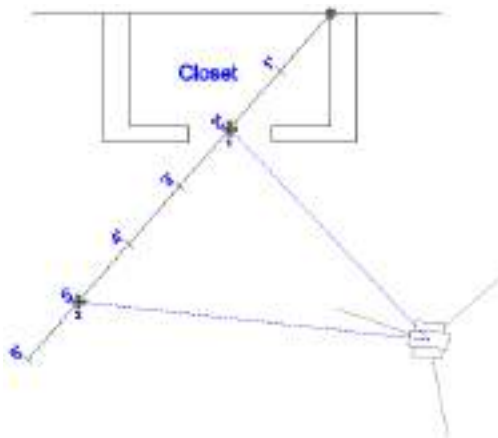

After you take your two measurements, all you need to define is the offset distances. In this example, the corner is two feet to the right of the first measurement (point 1), and 8' up from the floor. After you define the offset directions and offset amounts, you can press the **Store Pnt** button to store the new point.

Line - Distance Offset

Highlight a point on the line and press the measure button to record an observation. All offsets are respect to Point 1.

Point	Horizontal ...	Vertical A...	Slope Dist..	HR	HI
Line - P...	356°23'58"	85°54'35"	21.33'	4.27'	5.25'
Line - P...	350°02'09"	85°33'33"	29.31'	4.27'	5.25'

Horz Offset Right of Pnt 1: 2.00'
 Perp Offset Away From Inst: 0.00'
 Elev Offset Up: 8.00'

Measure Store Pnt  Close

Add Invert

[Main Menu or Instrument Toolbar](#) | [Measure Modes](#) | [Offsets](#) | [Add Invert](#)

If you've manually measured a distance to an invert, you can have FieldGenius compute a point with a computed invert elevation.

When you start the command you will see the Invert Toolbar appear towards the bottom of your main screen.

Store Pnt  Pick Pnt Invert 0.000m 

First you need to specify the point that will be referenced to compute the invert elevation. You can do this by using the point chooser button.

Now enter the measured distance to the inverse. For example if your measurement was 5.5', FieldGenius will subtract this from the reference point's elevation. Entering a negative value will cause it to be added.

Press **Store Point** to create and save a point with the calculated invert distance. This point will have the same northing and easting value as the reference point.

Note:

While the invert toolbar is open, you can continue entering invert measurements or choose different reference points.

Raw File

When you save the point, an offset and store point record will be created.

```
--OS,OP7,FP8,ND0.000,ED0.000,LD5.000
SP,PN8,N 935.976,E 1232.356,EL5.000,--<No Desc>
```

Intersections

Two Line Intersection

[Main Menu or Instrument Toolbar](#) | [Measure Modes](#) | [Intersections](#) | [Two Line Intersection](#)

The two line intersection command is used to locate the corner of an object, whose corner cannot be directly measured. Two intersecting lines will be defined by four measurements, two shots on each line. The intersection of these two lines will define the corner of the object. This routine is intended to be used with a reflectorless total station.

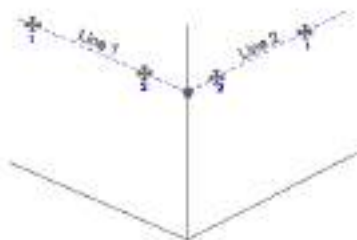

Measure Points

When you start the two line intersection command, you will see an empty list. Each row represents a measurement to a point on one of the two lines needed to compute the intersection.

Highlight the row that you would like to make a measurement for and simply press the **Measure** button to begin the measuring process.

If you need to redo a measurement, simply highlight it in the list and press the measure button.

Notes:

1. You can shoot the points in any order you like, FieldGenius will determine what direction to go in to compute an intersection
2. The northing and easting values for the new point will be computed using the intersection of the two lines.
3. The two lines you define will rarely intersect at exactly the same point. The elevation of where the lines intersect will be averaged, and used as the z value for the new point.

Point	Horizontal	Vertical A.	Slope Dist.	HR	HI
Line 1 - P.	45°00'00"	90°00'00"	25.000m	0.000	0.000
Line 1 - P.	90°00'00"	90°00'00"	30.000m	0.000	0.000
Line 2 - P.	270°00'00"	90°00'00"	35.000m	0.000	0.000
Line 2 - P.	315°00'00"	90°00'00"	25.000m	0.000	0.000

Measure Store Pnt  Close

Note: You can increase the size of the text shown in the grid by setting the Text Size option in the [Options screen](#).

Store the Point

Once you've made measurements to the four points that will define the two intersection lines, you can press the Store Point button. This will store a point in the map screen, store a point in the database as well as record information to the raw file.

Raw File

Everything about the intersection is stored in the raw file.

```

--Two Line Intersection
--HI1.340,HR0.000,AR280.55220,ZE81.15170,SD6.8350,--Pnt 1 of Line 1
--HI1.340,HR0.000,AR276.59380,ZE81.05590,SD6.4400,--Pnt 2 of Line 1
--HI1.340,HR0.000,AR287.18580,ZE81.13350,SD6.7960,--Pnt 1 of Line 2
--HI1.340,HR0.000,AR296.06280,ZE80.14520,SD6.0940,--Pnt 2 of Line 2
SP,PN3,N -0.0039,E -0.0060,EL0.5325,--
    
```

Line - Angle Intersection

Main Menu or Instrument Toolbar | Measure Modes | Intersections | Line - Angle Intersection

The **Line-Angle Intersection** command is used to define two points that will be used to establish a reference line then measure an angle that intersects this reference line, and FieldGenius will automatically compute the coordinate at the intersecting point.

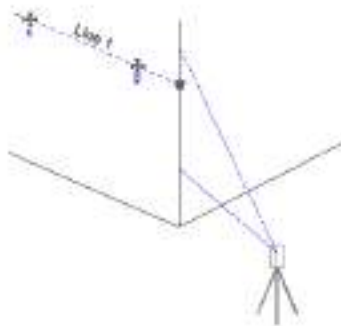

An example of where you might use this is to locate the corner wall of a building. Simply shoot two points on one of the walls, then turn the instrument so it is pointing anywhere along the corner of the building. This command is intended to be used with reflectorless total stations.

Measure Points

When you start the **Line-Angle Intersection** command, you will see an empty list.

Highlight the row that you would like to make a measurement for and simply press the **Measure** button to begin the measuring process.

If you need to redo a measurement, simply highlight it in the list and press the measure button.

Notes:

1. You can shoot the points in any order you like, FieldGenius will determine what direction to go in to compute an intersection
2. The northing and easting values for the new point will be computed using the intersection of the line and the angle that was read.
3. The z value for the new point will be computed using the projected elevation along the reference line to the point where an intersection is computed.



Note: You can increase the size of the text shown in the grid by setting the Text Size option in the [Options screen](#).

Store the Point

Once you've made your measurements that will be used to compute the intersection, you can press the **Store Point** button. This will store a point in the map screen, store a point in the database as well as record information to the raw file.

Raw File

Everything about the intersection is stored in the raw file.

```
--Line - Angle Offset
--HI1.340,HR0.000,AR280.55530,ZE81.12550,SD6.8330,--Pnt 1 of Line
--HI1.340,HR0.000,AR277.37420,ZE80.47010,SD6.5020,--Pnt 2 of Line
--HI1.340,HR0.000,AR283.46460,ZE86.15500,--Angle Offset
SP,PN4,N -0.0050,E 0.0051,EL0.5761,--
```

Line - Perpendicular Point

[Main Menu or Instrument Toolbar](#) | [Measure Modes](#) | [Intersections](#) | [Line - Perpendicular Point](#)

This offset command is used to define two points that will be used to establish a reference line. Once the reference line is established, you can specify a point that will be used to compute a perpendicular intersection from the point to the reference line. The point can either be shot or you can select an existing point from your scene database or map.

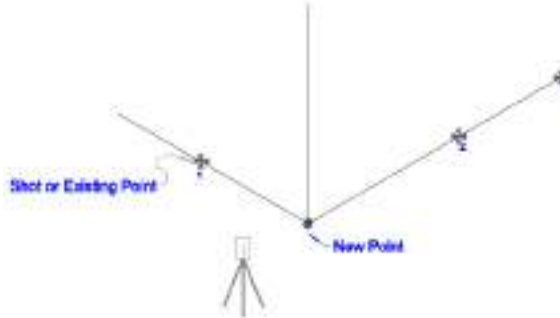

An example of where you could use this is to pick up the corner of a building, whose corner cannot be seen from the total station. You could take two shots on one wall to define the reference line, and then take another shot on the intersecting wall. A perpendicular intersection will be computed, which in this case would be the corner of the building.

Measure Points

When you start the command, you will see an empty list.

Highlight the row that you would like to make a measurement for and simply press the **Measure** button to begin the measuring process.

If you need to redo a measurement, simply highlight it in the list and press the measure button.

Notes:

1. The northing and easting values for the new point will be computed by computing a perpendicular intersection between the reference line and a point defined by the user.
2. The z value for the new point will be computed using the projected elevation along the reference line to the point where a perpendicular intersection occurs.

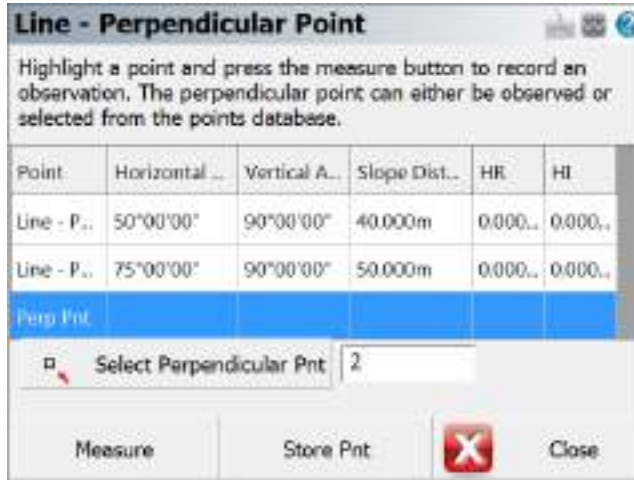

Note: You can increase the size of the text shown in the grid by setting the Text Size option in the [Options screen](#).

Select Perpendicular Point

You can define the perpendicular point one of two ways. The first is to simply take a measurement that will define the perpendicular point. The shot is only used to make an intersection, a point isn't stored at the measurement location.

The other method is to choose an existing point that exists in your scene. Press the Select Perpendicular Pnt button to select a point.

Store the Point

Once you've made your measurements and defined a perpendicular point that will be used to compute the intersection, you can press the Store Point button. This will store a point in the map screen, store a point in the database as well as record information to the raw file.

Raw File

Everything about the intersection is stored in the raw file. In the following example, if you shot the perpendicular point you will see a third shot that records the measurement.

```
--Line - Perpendicular Point
--HI1.340,HR0.000,AR353.49130,ZE80.47360,SD21.3386,--Pnt 1 of Line
--HI1.340,HR0.000,AR357.07260,ZE81.13020,SD22.4245,--Pnt 2 of Line
--HI1.340,HR0.000,AR12.10230,ZE83.00580,SD19.8819,--Perpendicular Pnt
SP,PN6,N 123.3028,E 100.0209,EL104.7737,--RM
```

If the perpendicular point exists in your scene and you selected it using the point chooser, then you will see a store point recorded as a note. The last store point is the new point that was computed.

```
--Line - Perpendicular Point
--HI1.340,HR0.000,AR353.49520,ZE80.46560,SD21.3419,--Pnt 1 of Line
--HI1.340,HR0.000,AR357.07330,ZE81.12210,SD22.4147,--Pnt 2 of Line
--SP,PN7,N 119.2906,E 104.1611,EL103.7580,--Perpendicular Pnt
SP,PN8,N 123.3107,E 100.0504,EL104.7751,--SCR
```

Trilateration

[Main Menu or Instrument Toolbar](#) | [Measure Modes](#) | [Intersections](#) | [Trilateration](#)

This routine allows you to trilaterate the position of new points by observing their distances from two known positions. The two known points will make up a baseline, from which a distance-distance intersection will be calculated to determine the position of each new point.

The primary use of this routine is for GNSS users so they can locate inaccessible points. They can locate two points with GNSS, and then use the Trilateration routine to locate the inaccessible points.

This routine can accept distances measured with the Leica Disto.

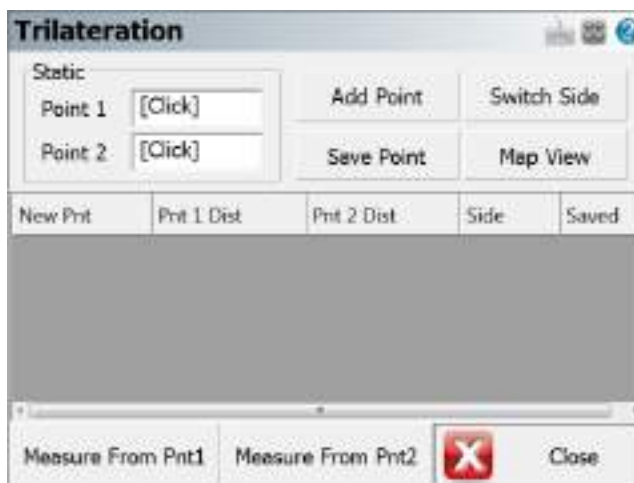

Static Points (Baseline)

Select your two baseline points, from which you will be observing the distances to the new points.

Add Point

Use this to add a new unknown point to solve for. When you press this, you will be prompted for the new point number and description, and whether it is on the left or right side of the baseline.

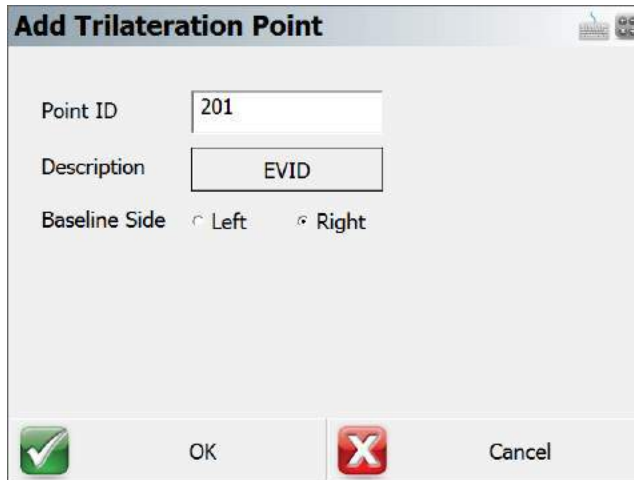



Add Trilateration Point

Point ID: 201

Description: EVID

Baseline Side: Left Right

 OK  Cancel

Save Point

This saves the selected New Point into your Project database.

Switch Side

This toggles the selected New Point to the Left or Right side of the baseline.

Map View

This takes you to a map view showing your baseline, the distance measured from each point, and the calculated position of the new point.

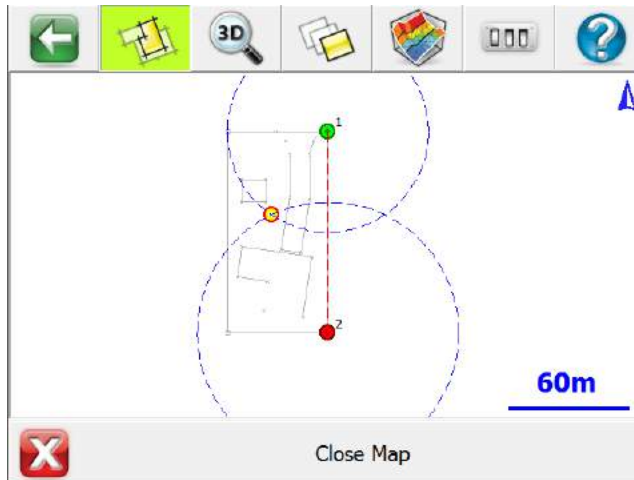

If desired, you can press the World View button on the [Display toolbar](#) to hide unnecessary data.

Measure from Point 1

Press this to record the distance from Point 1 of your baseline to the selected New Point.

Measure from Point 2

Press this to record the distance from Point 2 of your baseline to the selected New Point.

Vertical Plane Projection

[Main Menu or Instrument Toolbar](#) | [Measure Modes](#) | [Intersections](#) | [Vertical Plane Projection](#)

This function is for locating multiple points on a vertical plane defined by two previously measured points. The program will calculate the distance for each shot taken to an un-measurable position so that coordinates can be generated for the shot.

An example of how you could use this would be to shoot two corners of a wall to define a vertical plane. Then you could sight four corners for window on the second floor and FieldGenius will use the HA and VA values and compute the intersection with the vertical plane. Once the intersection is computed, the point will be stored.

Function

When the command is started you will see a screen that will allow you to specify the points that will form the baseline for the vertical plane.

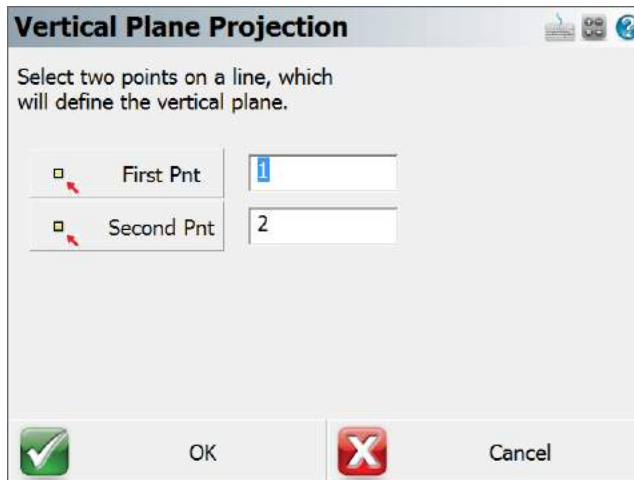

Note: You need to measure and store the points that will be used to define the vertical mapping plane, prior to starting the Vertical Projection command.

When ready to continue, press the **OK** button.

You will now be in the Vertical projection mode which will be indicated by the Measure Mode button on the instrument toolbar. To begin calculating points on the vertical plane, you need to point the total station at the new point you want to create. To complete the shot, press the measure button, and then store the point.

Note: You do not need to use a prism when measuring points on the vertical plane. Simply point the instrument at the point you want to create.

Since vertical planes represent 3D data, it is sometimes necessary to rotate your perspective of the Project to help you see the point you're computing on the vertical plane.

Press the 3D View button on the [display toolbar](#) which will open the 3D toolbar. If you press the Planar View button, your scene will be rotated so it matches your perspective. For example, a vertical plane was defined by points 27 and 28. When the planar view option is used, you can see your work in a 3D perspective. You can now see the 4 measurements (points 500 – 503) that were made to record the position of a window on the vertical plane.



Plan View

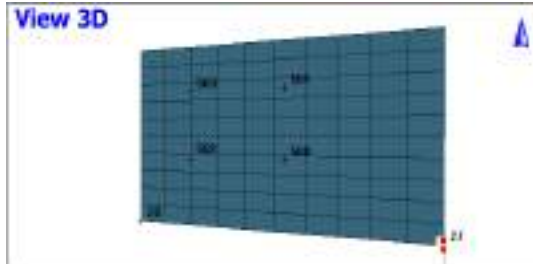

3D Perspective

You can also hide objects that are behind the vertical plane from viewing by pressing the **Vert Grid** button. In the example below, you will see that after this is turned on, some of the line work is hidden from view.

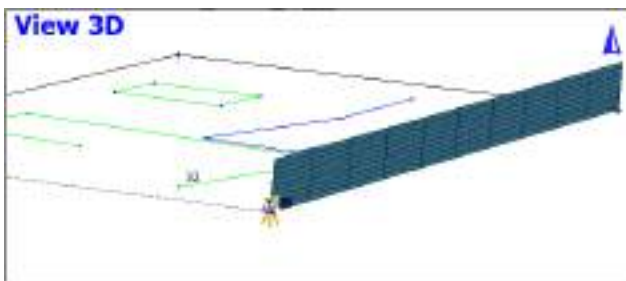

To exit this routine, simply switch to a different Measure Mode.

Raw File

Each point that is computed on the vertical plane will also have a computed sideshot stored in the raw file.

```
--VS, PA27, PB28
SS, OP1, FP503, AR142.24510, ZE78.37170, SD17.8888, --VERTICAL
```

For each shot you record you will see a note before the shot in the raw file indicating which points were used to define the vertical plane.

Special Notes

Vertical projection measurements will automatically be recognized by your MicroSurvey CAD or inCAD desktop software. Please refer to the MicroSurvey CAD or inCAD help file for more information regarding importing vertical projections.

Point Scanning

Main Menu or Instrument Toolbar | Measure Modes | Point Scanning

FieldGenius supports point scanning which allows you to create a point cloud of data. To use this routine you need a reflectorless instrument that has servo motors.

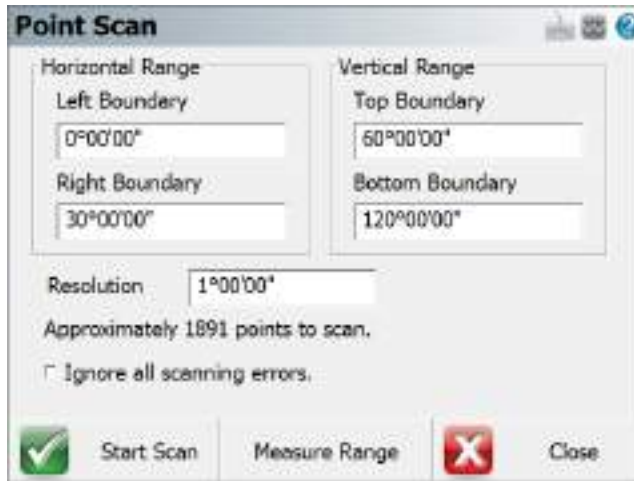

To start, you will be asked to define a scan area by pressing the Measure Range button and pointing the instrument at the Bottom-Left and Top-Right corners of the area you want to confine the scanning to.

Once the scan area is defined, you can define the scan resolution by using an angular value. For example if you set it to 0°30'00", FieldGenius will create a pattern confined to the limits you defined, and scan at 30 minute intervals both horizontally and vertically. Once you've defined the scan area and resolution, FieldGenius will display an estimate of how many points will be stored.

You also can control how FieldGenius deals with measurement errors while scanning. If you turn on "**Ignore all scanning errors**", FieldGenius will ignore measurement errors and continue without interruption. If you don't turn this on, FieldGenius will stop and display a message allowing you to stop the scanning process, or continue on with the next measurement.

Press the **Start Scan** button to select the desired reflectorless EDM Mode and initiate scanning. FieldGenius will display an estimate of the time remaining for the scan to complete.

Points will be stored using the description defined in the map screen. The point number of the first point will be set to the "next available" id and will increment sequentially. The shots are stored in the raw file as sideshots so you have a record of the observations.

Upon completion, you will receive a summary showing the total number of successful measurements and errors received.

Scan Settings

When connected to the Leica MS50/MS60 and you select the Point Scanning command you will see the Scan Settings dialog.

Scan Settings - Type

Scan Method

You have 4 options

- Polygon area - Scan area confined by polygon vertices (video scanning supported)
- Rectangular area - Scan a rectangular area defined by 2 opposite corners (video scanning supported)
- Full Dome - Scan the entire field of view of the total station
- Partial Dome - Scan area confined by angler constraints. Can also be used to scan Ceilings or Floors

Scan Rate

Define the scan rate you want to use. High density scans require more time to complete, while lower density scans require less time.

Store SNR

Use this to control the recording of SNR data on each point captured with the MS50/MS60.

Artifact Filter

Use this to help eliminate ghost points and enhances the point cloud quality.

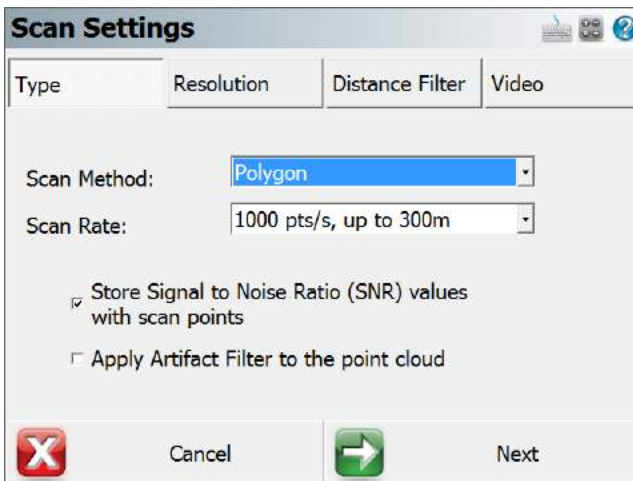

Scan Settings - Resolution

You can define the resolution of scan by distance or angle. The easiest is by distance.

Measure near the area you want to scan and press the DIST button, spacing information will be determined automatically.

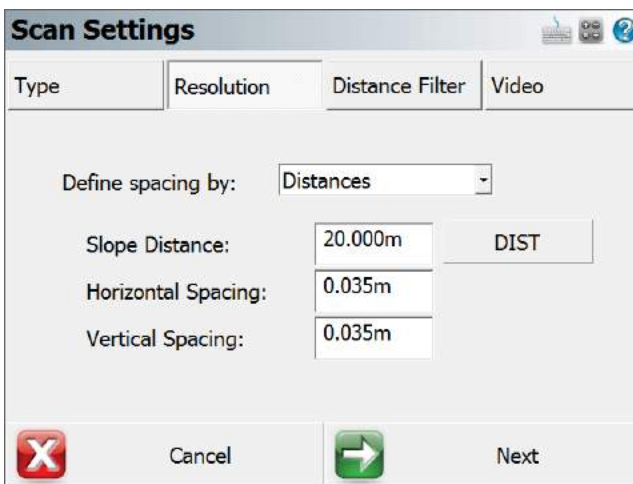

Scan Settings - Distance Filter

You can define a minimum and maximum distance filter that will help confine the scan data within this range.

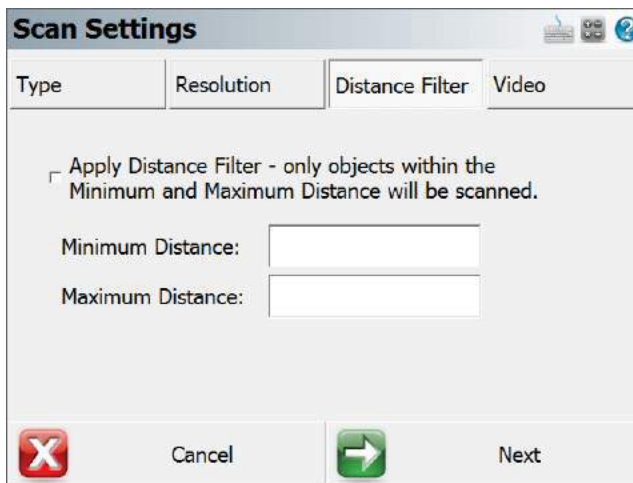

Scan Settings - Video

You can use the cameras on the total station to define scan area.

- This option is only applicable for Rectangular and Polygon modes.
- This option is only available on Windows desktop PC or tablet platforms.

View Streaming Video

This button Enable/Disable the video streaming feature. If video streaming is disabled, regular measurement mode will apply to define the scan area

If you are unable to turn on this button, please check the Bluetooth PAN or USB connection.

Connection

You can either use Bluetooth PAN connection or USB cable connection for streaming video views
See "Setup Video Streaming Connection" Section below for more details.

FrameRate

Use this to adjust frame rate of the video

Maximum BitRate

This setting controls the maximum video data transfer rate between total station and your data collector.

Lower this setting if you are experiencing high latency, slow response time, or video flickering in video extents view when using Bluetooth PAN connection.

We recommend lowest setting for Bluetooth PAN connection due to limited wireless bandwidth, and highest setting for USB Cable connection. **(These are default settings)**

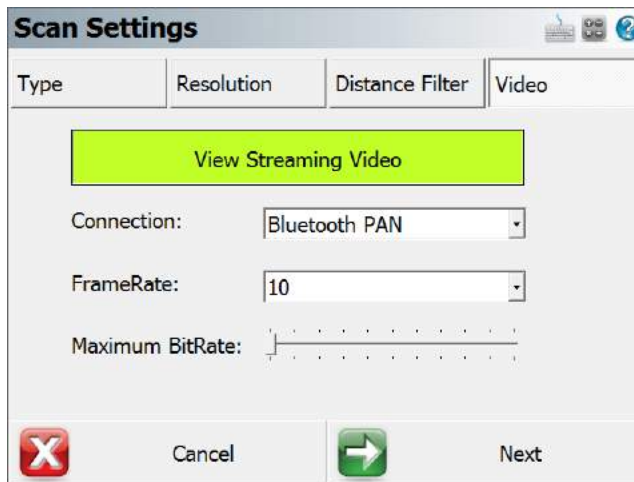

Setup Video Streaming Connection

This section details set up procedures for establishing Bluetooth PAN and USB cable connection

USB Cable Connection Setup

- Install Leica MS50/MS60 driver or Leica Viva/Captivate software that contains the driver on the PC/Tablet you wish to run FieldGenius
- Connect Leica Lemo 8-pin to USB cable to the PC/Tablet

Bluetooth PAN Connection Initial Setup

NOTE: ALL setup steps below are one-time-only. This setup guide is also available as a video on MicroSurvey.com

- On a Bluetooth capable Windows PC or tablet, go to **Control Panel -> Network and Sharing Center -> Change Adapter Settings**
- Locate **Bluetooth Network Connection**, right click on the icon and select **Properties**.
- Under **Networking** tab, click on **Internet Protocol Version 4 (TCP/IPv4)**, then click on **Properties** again
- Select **Use the following IP address:**, and enter **192.168.253.100** as IP address, and **255.255.255.0** as Subnet mask
- Click **OK** twice to save the settings

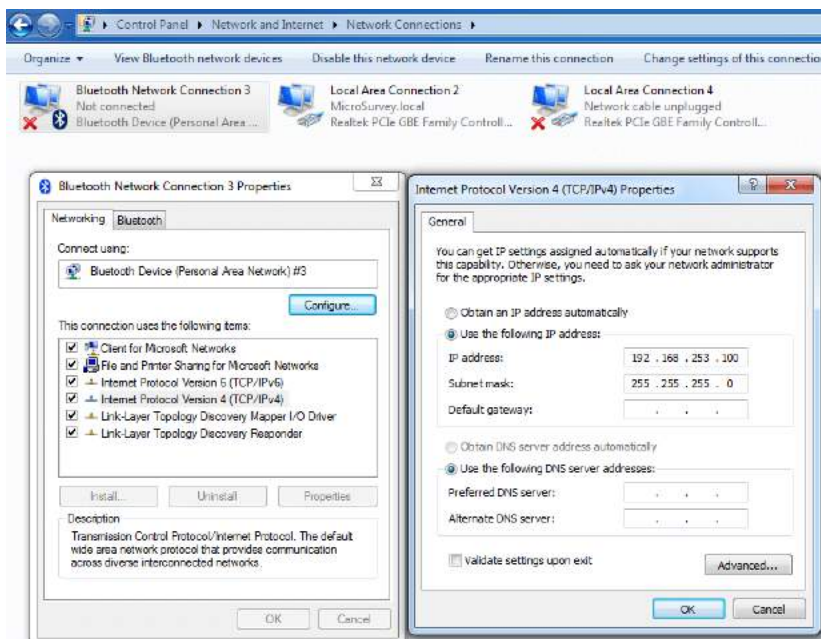

- Now go to **Control Panel -> View Devices and Printers** or alternatively right click **Bluetooth task bar status icon**, and select **Show Bluetooth Devices**
- From either places, click **Add a device** button to add MS50/MS60 (names as TS or TSxxxxxx) as a device. Make sure the instrument is turned on and within range.
- When asked for **pairing code** or **PIN**, make sure to enter **0000** as code on both Windows and MS50/MS60 instrument.
- The MS50/MS60 instrument is now successfully paired with your PC/Tablet. All steps above are one time only

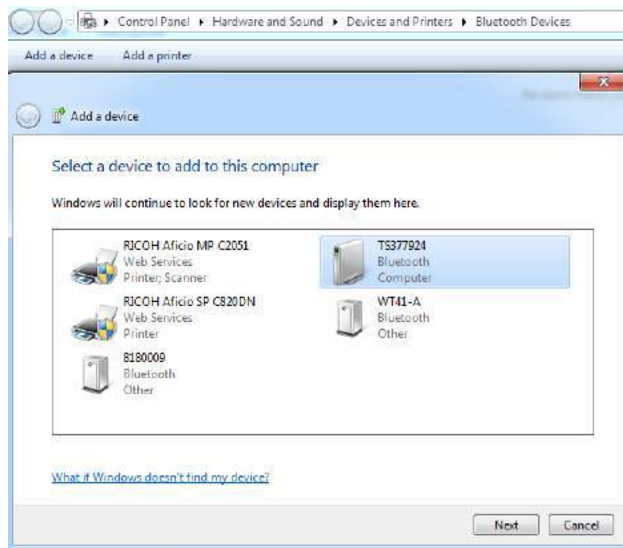

Bluetooth PAN Connection Setup

- Once the initial setup is completed, you should be able to see your instrument under **Bluetooth devices** or **Devices and Printers** screen
- Right click the MS50/MS60 instrument, select **Connect using**, then click **Ad hoc network**
- Windows may take a few seconds to finish the connection. You are now good to go!

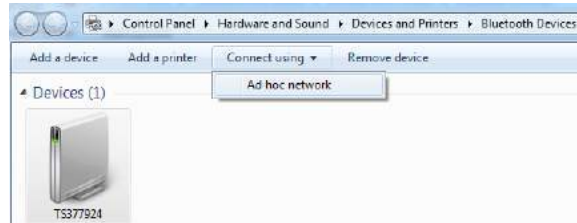

Bluetooth PAN Troubleshoot or Reset

- If your Bluetooth PAN connection is unstable or video camera cannot be started, you can follow the steps below to reset the connection
- Remove MS50/MS60 instrument from Bluetooth device list on your PC/Tablet
- On MS50/MS60, hold the **Power** button, and choose **Reset**, and select **Reset Windows CE**. This will clear WinCE system settings.
- Follow the steps above to re-add MS50/MS60 instrument in the Bluetooth device **using PIN code 0000**

Scan Extent - Partial Dome

Partial Dome scan routine can help you:

- Define a rectangular shaped scan area by entering four angular constraints
- Define a donut shaped scan area by checking on **360 Horizontal Scan Area** option.

A practical application of the donut mode would be to either scan Ceilings or Floors by limiting the 2 vertical angles.

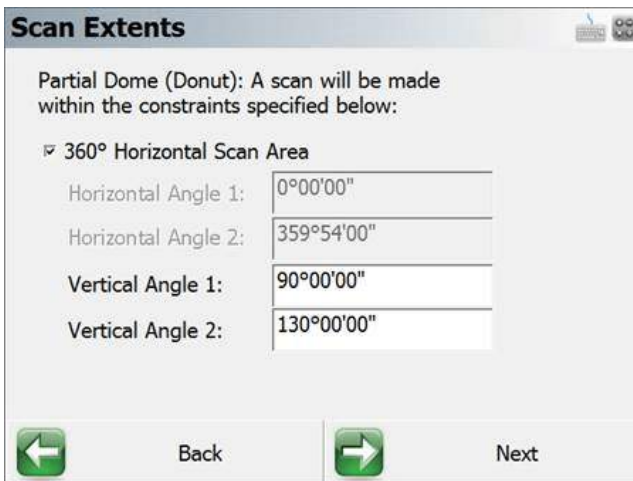

Video Scan Extents

When Point Scanning settings are confirmed, and "View Streaming Video" option is turned on, you will be directed to the Video Scan Extents screen

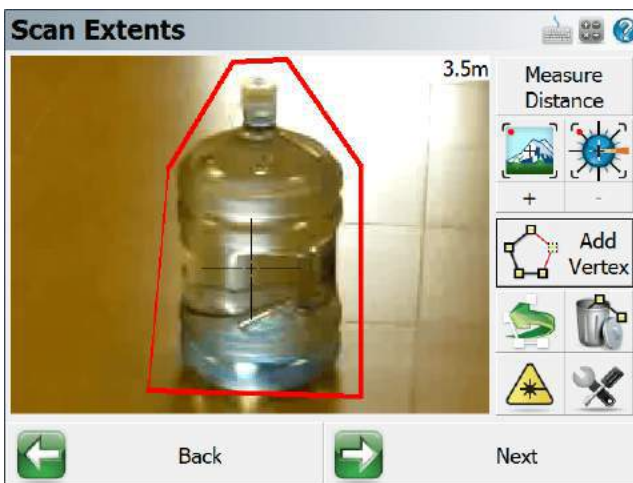

A detailed video walkthrough of this feature is available at MicroSurvey.com

Scan Extents Icons

Note: Click and hold any buttons will show a tool tip of the button.

Measure Distance

Measures the distance of the object at crosshair. It is recommend to measure distance before adding polygon vertices with overview camera.

Current distance is displayed at the upper-right corner of the video screen.

If the camera is moved, a "Distance Required" text will be displayed instead of the number.

Overview Camera

This is the default camera - ideal for shorter distance.

The Overview Camera is NOT aligned with the total station scope, and will require user "Measure Distance" before adding each polygon vertex to align the crosshair and the scope/laser.

On-Axis Camera

This camera is ideal for longer distance.

The On-Axis Camera is aligned with the total station scope, you can add vertices directly without "Measure Distance"

Zoom In

This will zoom in on the camera view

Zoom Out

This will zoom out on the camera view

Add Vertex

Vertices can be defined using this button to form a scan area.

Remove Vertex (Undo)

Use this button to remove the previously defined vertex

Clear All Vertices

You can clear the all previous defined vertices

Set Laser Pointer ON/OFF

You can toggle laser pointer on the total station on or off

More Options

This button will open up Camera Settings dialog

- Auto-Focus - Turn on auto focus of the selected camera
- Focus at Distance - Focus the camera at the distance measured

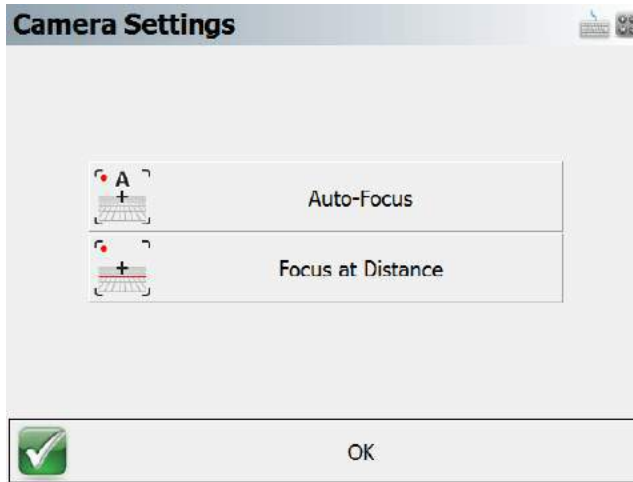

Video Scan Workflow

You can choose to use either Overview Camera or On-Axis Camera to define the scan area, based on distance, video quality, or other factors.

Overview Camera

- Turn on laser pointer.
- Move the crosshair to the edge of the scanning area by directly clicking the video itself.
- You will notice the crosshair has a circle in the middle, and a "Distance Required" text on the upper-right corner of the video view.
- Click "Measure Distance" button to determine the slope distance, and the software will align the crosshair with the laser/scope.
- Click "Add Vertex" button to add the first polygon vertex.
- Repeat previous steps until the scan area is defined.
- Note: if the scanning object is efficiently far away from the total station, then the misalignment between crosshair and laser/scope will be small. You can directly add vertex without the measuring distance, and the scanning area will be similar to what you would see on the video screen.

On-Axis Camera

- Move the crosshair to the edge of the scanning area by directly clicking the video itself.
- Zoom to the appropriate level
- Click "Add Vertex" button to add the first polygon vertex.
- Repeat previous steps until the scan area is defined.

Scan Complete

When Point Scanning is completed, a few options will be available to you.

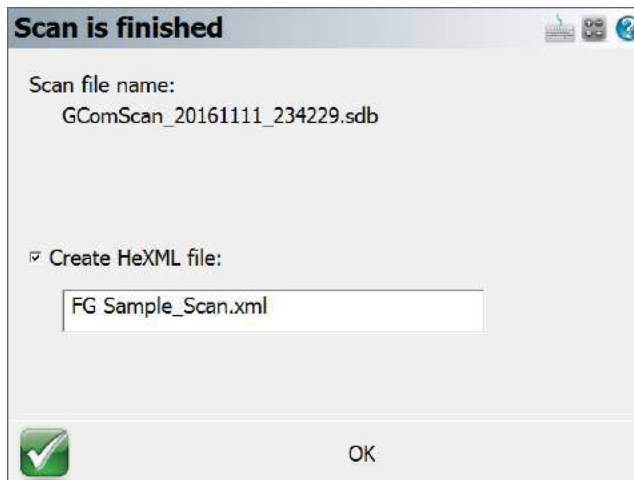

Scan Complete Options

Scan File Name:

The Scan file is normally stored in the SD Card inserted into the Total Station. The scan file name will help you to locate the correct file, if you wish you manually transfer the file.

Create HeXML File:

You can export the Project into HeXML format directly. If this option is skipped, you can also go to "Import/Export" menu, and choose "Export LandXML" option

If there are multiple scan files in the same Project, and the same xml file name is used. The xml file will be overwritten to include all scan files currently in the Project folder

Transfer Scan File to Local Project Folder:

You must manually copy the scan files into your Project folder. (Requires "Scans" sub folder) Automatic transfer over Bluetooth is no longer possible due to transfer rate and the size of scan files.

For Example:

...\Documents\MicroSurvey\FieldGenius\FG Projects\[ProjectName]\Scans*.sdb

Manual

Manual Entry

[Main Menu or Instrument Toolbar](#) | [Measure Modes](#) | [Manual](#) | [Manual Entry](#)

When you set the Measure Mode to manual entry on the instrument toolbar you will be required to manually input your measurements. When you press the measure button you will see the following screen:

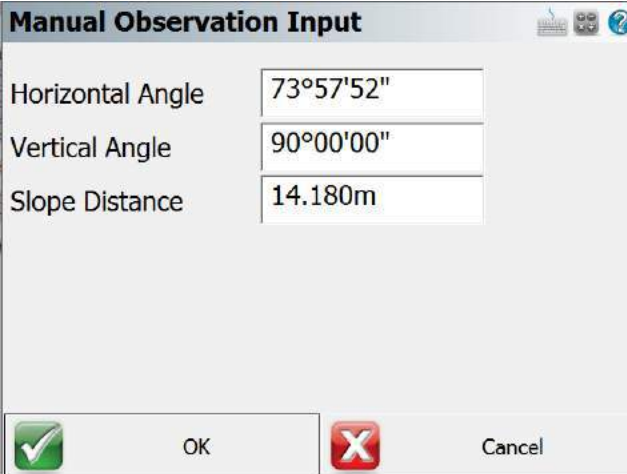

The image shows a dialog box titled "Manual Observation Input". It contains three input fields: "Horizontal Angle" with the value "73°57'52\"", "Vertical Angle" with the value "90°00'00\"", and "Slope Distance" with the value "14.180m". At the bottom, there are two buttons: "OK" with a green checkmark icon and "Cancel" with a red X icon.

Field	Value
Horizontal Angle	73°57'52"
Vertical Angle	90°00'00"
Slope Distance	14.180m

Press **OK** to Store the point.

A normal sideshot or traverse record will be written to the raw file just as if you shot it with a total station.

Tip:

You can also use the Manual Entry mode for repeating your last shot. If you have previously taken a measurement, then the angle and distance values on this screen will default to those of your previous shot.

Manual Distance

[Main Menu](#) or [Instrument Toolbar](#) | [Measure Modes](#) | [Manual](#) | [Manual Distance](#)

Use this mode to shoot an observation where only the horizontal and zenith angles will be measured with the instrument. You will be then prompted to enter the distance.

When you set the Measure Mode to manual distance and press the measure button the horizontal and vertical angles will be read from your total station. Since this is only measuring angles, you do not need to have a prism to shoot to.

Following this you will see a screen allowing you to enter a horizontal distance.

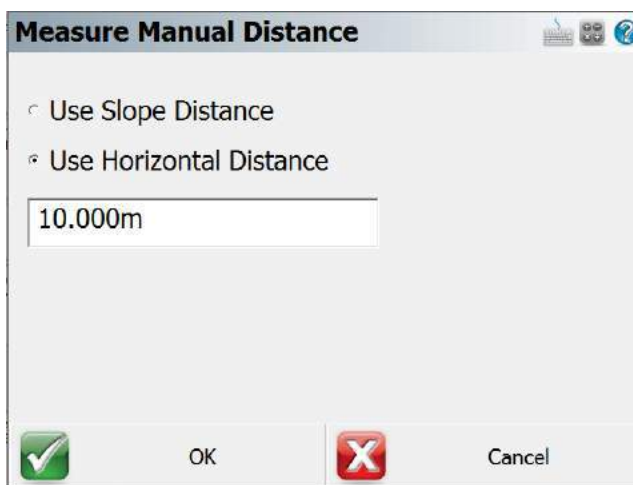

Measure Manual Distance

Use Slope Distance

Use Horizontal Distance

10.000m

OK Cancel

Press **OK** to save the point. You will now see the measurement info screen.

A regular sideshot or traverse record will be created in the raw file.

Measure Modes (GNSS Reference)

Main Menu or Instrument Toolbar | Measure Modes

When you connect to a reference receiver you need to program a position into the receiver so accurate positions can be transmitted to the rover.

You can access the different Measure Modes to program your receiver with a position by selecting the Measure Modes button in the main menu, or the Measure Modes button on the GNSS instrument toolbar.

Main Menu - Measure Modes

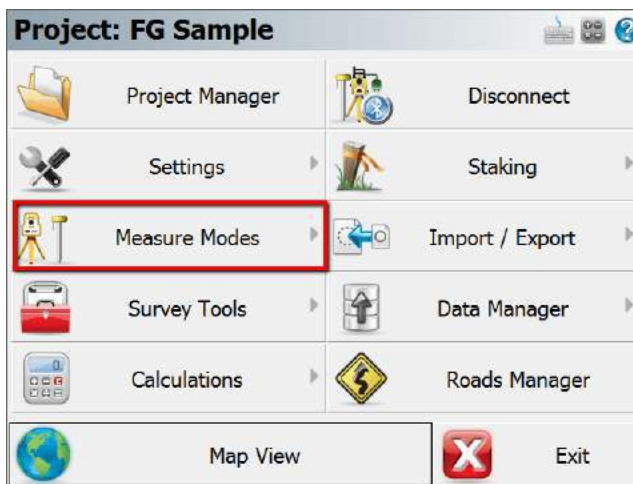

Instrument Toolbar



Selecting the Measure Modes button will display these options:

1. [Known Geodetic Position](#)
2. [Averaged Geodetic Position](#)
3. [Local Transformation to Point](#)

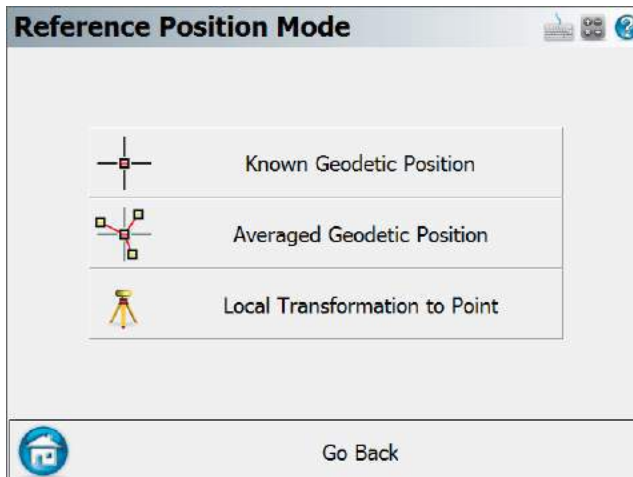

Overview

There are three different modes available for programming a position into your reference receiver. When you're ready to program your base receiver with a position you need to select the reference position mode then to start the process press the **Measure** button on the [GNSS toolbar](#). Please review the following sections for a detailed explanation of how each mode is used.

Known Geodetic Position

[Main Menu or GNSS Toolbar](#) | [Measure Modes](#) | [Known Geodetic Position](#)

Use this when you know the geodetic position of the point the base is setup on. You have two options, you can program it with a known Geodetic or known Cartesian Coordinate.

The image shows a software dialog box titled "Reference Position". It has two columns of input fields. The left column is for Geodetic coordinates, and the right column is for Cartesian coordinates. The Geodetic fields are Latitude (N49°50'16.78735"), Longitude (W119°36'36.12700"), and Ellipsoidal Hgt (390.887m). The Cartesian fields are Northing (5523886.413m), Easting (312329.456m), and Elevation (390.887m). Below the fields are two buttons: "Select Position From Database" and "Modify Antenna Height". At the bottom, there are three buttons: a green checkmark icon, "Set Position", a red X icon, and "Cancel".

Geodetic	Cartesian
Latitude	Northing
N49°50'16.78735"	5523886.413m
Longitude	Easting
W119°36'36.12700"	312329.456m
Ellipsoidal Hgt	Elevation
390.887m	390.887m

Select Position From Database

Modify Antenna Height

Set Position Cancel

Geodetic Coordinates

Enter the know Latitude, Longitude and Ellipsoidal Height for your base setup. The coordinates you enter here will be programmed into the receiver.

Cartesian Coordinates

Cartesian coordinates can be SPCS, UTM coordinates or any other grid system as long as it matches the horizontal and vertical system you've defined in your GNSS profile. You cannot enter local coordinates as Cartesian coordinates! Doing so will cause a warning message to be displayed indicating that the coordinates you entered do not fall inside the GNSS grid files you have loaded on your data collector.

Select Position from Database

This allows you to choose a point a number of different ways. The point you select must be a grid coordinate such as a SPCS or UTM coordinate.

Averaged Geodetic Position

[Main Menu or GNSS Toolbar](#) | [Measure Modes](#) | [Averaged Geodetic Position](#)

Use this to measure and average an Autonomous Geodetic position.

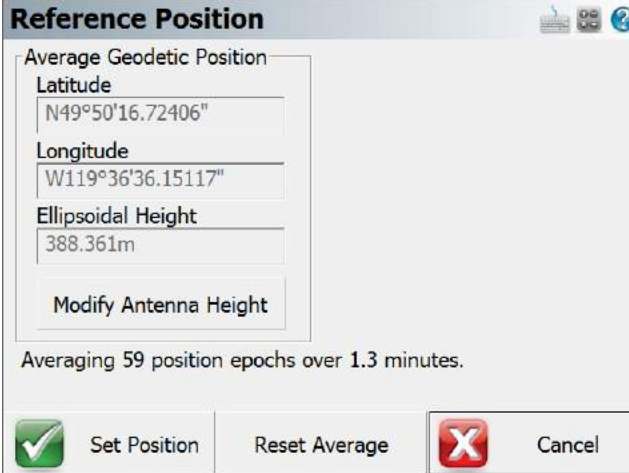

The image shows a software dialog box titled "Reference Position". It contains a section for "Average Geodetic Position" with three input fields: "Latitude" (N49°50'16.72406"), "Longitude" (W119°36'36.15117"), and "Ellipsoidal Height" (388.361m). Below these fields is a button labeled "Modify Antenna Height". At the bottom of the dialog, there is a status line that reads "Averaging 59 position epochs over 1.3 minutes." and three buttons: "Set Position" (with a green checkmark icon), "Reset Average", and "Cancel" (with a red X icon).

It is up to you to determine how many observations or the duration of time you want to wait before accepting the averaged position. At any time you can restart the process by pressing the **Reset Average** button.

If you press **Set Position**, your receiver will be programmed with the new position and you will have the option of storing a point's position in the database.

Local Transformation to Point

[Main Menu or GNSS Toolbar](#) | [Measure Modes](#) | [Local Transformation to Point](#)

Use this to compute a one point transformation so your GNSS derived measurements can be referenced into a local system.

Reference Position	
Average Geodetic Position	
Latitude	N49°50'17.48137"
Longitude	W119°36'36.44581"
Ellipsoidal Height	385.444m
Modify Antenna Height	
Local Transformation Point	
Point ID	6
Northing	18.789m
Easting	-12.017m
Elevation	+0.006m
Averaging 15 position epochs over 0.3 minutes.	
<input checked="" type="checkbox"/> Set Position	<input type="checkbox"/> Reset Average
<input type="checkbox"/> Cancel	

When this option is used, FieldGenius starts receiving data and computes an averaged Autonomous position for the base receiver. The current position, how many epochs it has received and the total elapsed time is displayed on the screen.

It is up to you to determine how many observations or the duration of time you want to wait before accepting the averaged position. At any time you can restart the process by pressing the **Reset Average** button.

You then have to define a local coordinate that you want to localize to. It is assumed that the point exists in your Project. If it doesn't, simply double tap the Point ID field which will open the point tool-bar. You can use the new option to create a point or if it exists select it from the map or from the list.

When you press Set Position, FieldGenius will save the averaged location into the point database. It will then compute a one point transformation which is simply a horizontal and vertical shift from the grid coordinate system into your local system, as well as a combined scale factor. You will be presented with the option to apply the combined scale factor at the point

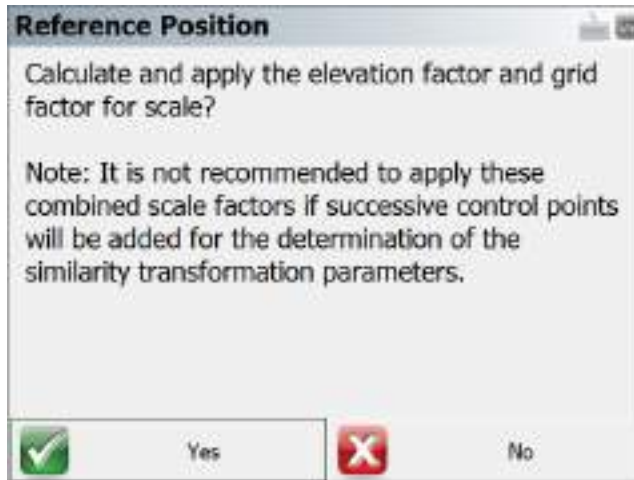

Pick **Yes** if:

- You are calculating a one point transformation and your Project coordinates are *ground-level* coordinates. Please Note: No rotation will be applied and the Project North direction will be Grid North as per your Project Coordinate System Settings.

Pick **No** if:

- You are calculating a transformation from multiple points and will be adding more points to the calculation. In this case the scale parameters will be determined from the best fit to all the points used for the transformation.
- You are calculating a one point transformation and your Project coordinates are grid coordinates as per your Project Coordinate System Settings.

All future GNSS measurements in the current Project will have your new transformation parameters applied automatically.

Measure Modes (GNSS Rover)

Main Menu or Instrument Toolbar | Measure Modes

When you connect to a rover receiver you will have a choice of Measure Modes available to you. You can access the different Measure Modes by selecting the Measure Modes button in the main menu, or the Measure Modes button on the GNSS instrument toolbar.

Main Menu - Measure Modes

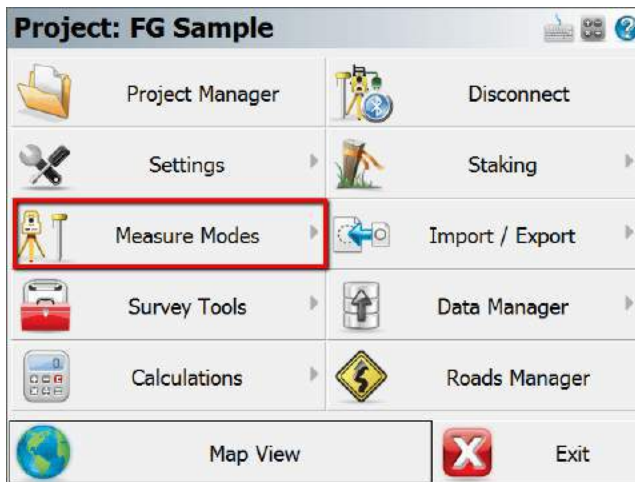

Instrument Toolbar

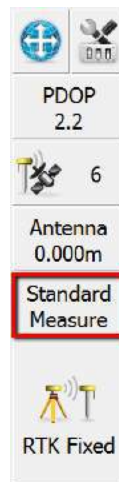

Selecting the Measure Modes button will display various options:

1. [Standard Measurement](#)
2. [Offset Measurement](#)
3. [Tilt Offset Measurement](#)
4. [Auto Record Points](#)
5. [Staking](#)
6. [Local Transformation Point](#)
7. [GroupCode](#)
8. [Check Point](#)
9. [Trilateration](#)
10. [Add Invert](#)

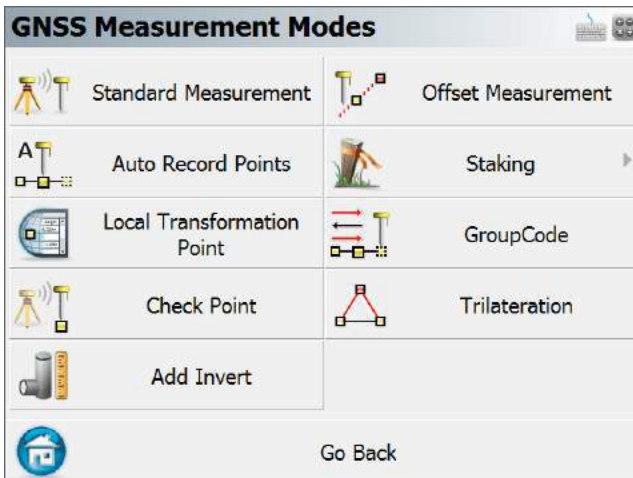

Standard Measurement

Main Menu or GNSS Toolbar | Measure Modes | Standard Measurement

When you have connected to your rover and you press the measure button on the [GNSS Toolbar](#) you will see the GNSS Measurement Screen

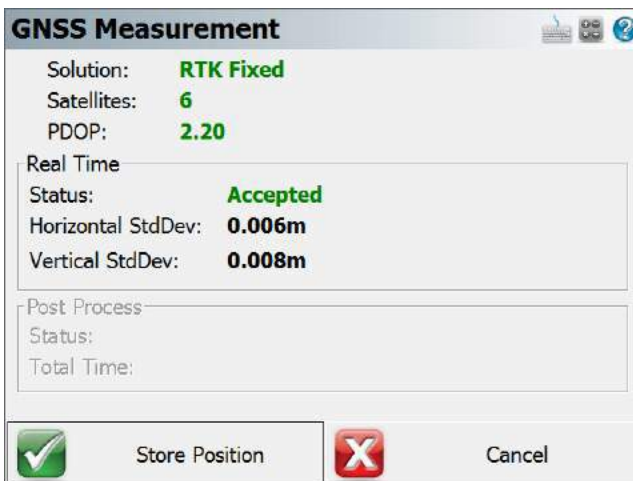

The measurement process works like this:

Once the satellites have been filtered out based on your [tolerance settings](#), FieldGenius will only begin collecting measurement data if all your tolerances are met. During the measurement process you might see that certain tolerances are not being satisfied, this is normal. FieldGenius will continue monitoring the measurement data and will accept measurements that pass the mask criteria.

Once the tolerances have been met, the position status will change to an **Accepted** position. Prior to accepting the position, the user can look at the RMS values for the computed position and determine if they wish to accept or reject the measurement. Pressing Cancel will exit the measure function without storing any data. Pressing [Store Position](#) will accept the position and store it in the database. You can change your true or measured Antenna Height on the Store Point screen.

By default, if you have some transformation parameters defined, they will be applied to the measurement prior to storing it.

If your current tolerance settings are not met, FieldGenius can switch from Real Time mode to Post Process mode to collect static data for that point for later post processing back in the office. This switch from Real Time mode to Post Process mode can occur automatically or manually, depending on your Post Process [tolerance settings](#). The duration of the Post Process measurement is specified in your tolerance settings, and depends on the minimum number of satellites tracked during the entire Post Process session.

Offset Measurement

[Main Menu or GNSS Toolbar](#) | [Measure Modes](#) | [Offset Measurement](#)

FieldGenius features a GNSS offset functionality to calculate an offset from the current position based on a direction and distance offsets. The direction may be determined from two observations. This feature is particularly handy when a direct observation is inaccessible or there is too much canopy coverage to get an RTK fixed position.

Function

When this mode is enabled FieldGenius the user will press the observation button to start the routine. After this, the GNSS Offset measurement screen as shown below will appear and is ready for the user to press the "Start Point" button to take the first shot. Once that is done the "Start Point" button will change to "End Point". Press this when you are on the second point and ready to take the second observation.

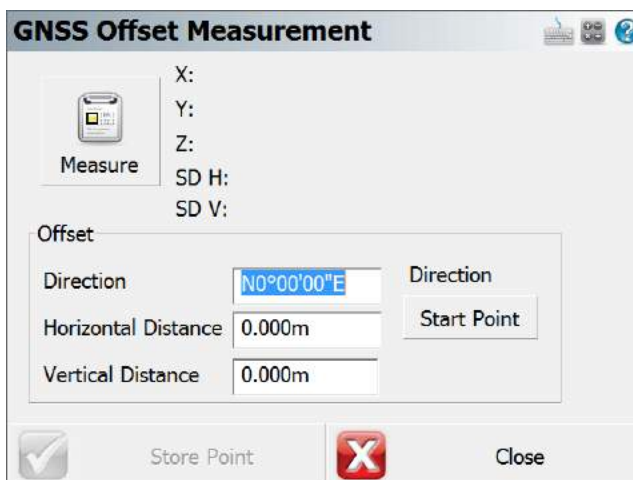

GNSS Offset Measurement

Measure

X:
Y:
Z:
SD H:
SD V:

Offset

Direction: N0°00'00"E Direction

Horizontal Distance: 0.000m Start Point

Vertical Distance: 0.000m

Store Point Close

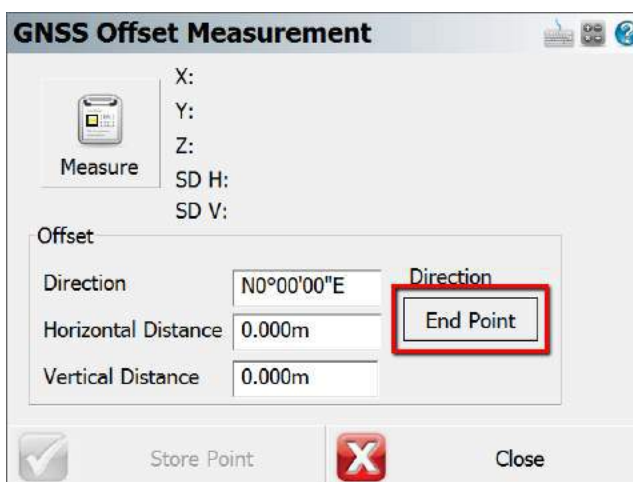

GNSS Offset Measurement

Measure

X:
Y:
Z:
SD H:
SD V:

Offset

Direction: N0°00'00"E Direction

Horizontal Distance: 0.000m End Point

Vertical Distance: 0.000m

Store Point Close

After both Start and End points are observed the Direction field will now be filled with the computed bearing between the two observed points. The next step is to manually enter in the Horizontal and Vertical distances to the new offset point. Fill these fields in and press the "Measure" button to take one more observation that will apply the computed direction, horizontal and vertical distances to the shot and will now populate the Northing, Easting and Elevation fields of the new calculated point in the GNSS Measurement area. The user can now press the "Store Point" button to store the calculated point into the database.

GNSS Offset Measurement

Measure

X:
Y:
Z:
SD H:
SD V:

Offset

Direction **N46°13'26"E** Direction

Horizontal Distance 0.000m **Start Point**

Vertical Distance 0.000m

Store Point Close

GNSS Offset Measurement

Measure

X:
Y:
Z:
SD H:
SD V:

Offset

Direction 221°13'50" Direction

Horizontal Distance 1.22' **Start Point**

Vertical Distance 0.30'

Store Point Close

GNSS Offset Measurement

 Measure

X: 5523056.154m
 Y: 311552.062m
 Z: 381.277m
 SD H: 0.991m
 SD V: 1.296m

Offset

Direction	<input e"="" type="text" value="N46°13'26"/>	Direction
Horizontal Distance	<input type="text" value="1.220m"/>	Start Point
Vertical Distance	<input type="text" value="0.300m"/>	



Store Point



Close

Additional Notes

The user has the option to manually enter in the direction to the offset point if it is already known. A vertical distance is not needed to calculate an offset point, only a Direction and a Horizontal distance are required to complete the routine.

Tilt Offset Measurement

Main Menu or GNSS Toolbar | Measure Modes | Tilt Offset Measurement

GNSS receivers usually comes with 2 measurement sensors (Tilt Sensor & Magnetic Sensor) to assist with tilted measurements (See [Electronic Bubble](#) section for more information)

The Tilt Sensor is more reliable and provides better accuracy compared to the Magnetic Sensor. This routine takes advantage of this, and only uses Tilt Sensor to Trilaterate a position what is difficult to survey without tilted pole measurement.

Two methods are available:

- Two Pole Tilt Intersection
- Three Pole Tilt Intersection

Two Pole Tilt Intersection

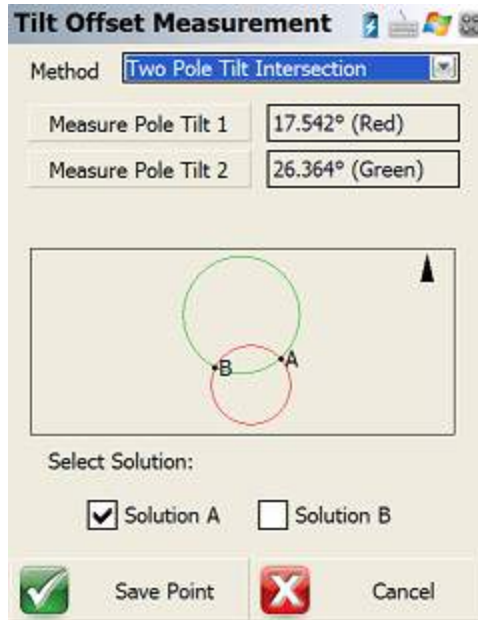

Make sure the button of the pole is at the same point

Measure Pole Tilt 1

Tilt the pole in one direction and Click this button to store the first tilt angle (Red Circle)

Measure Pole Tilt 2

Tilt the pole in the other direction and Click this button to store the first tilt angle (Green Circle)

There will be two intersecting points, choose Solution A or Solution B for the desired intersecting point, and click Save Point to Store it

Two Pole Tilt Intersection

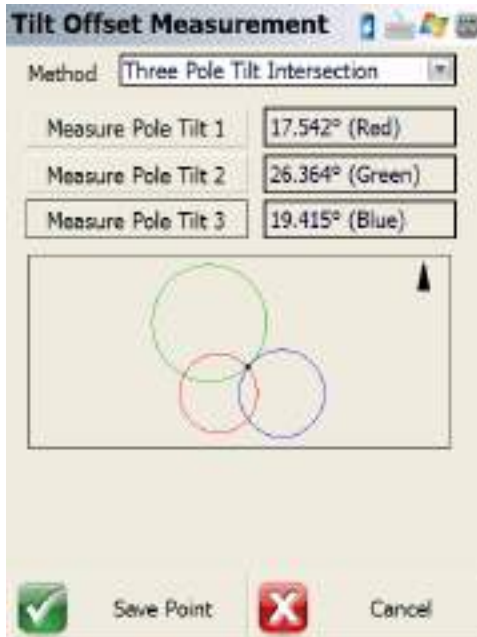

Make sure the button of the pole is at the same point

Measure Pole Tilt 1

Tilt the pole in one direction and Click this button to store the first tilt angle (Red Circle)

Measure Pole Tilt 2

Tilt the pole in another direction and Click this button to store the first tilt angle (Green Circle)

Measure Pole Tilt 3

Tilt the pole in the last direction and Click this button to store the first tilt angle (Blue Circle)

There will be only one intersecting point, click Save Point to Store it

Auto Record Points

Main Menu or GNSS Toolbar | Measure Mode | Auto Record Points

The Auto Recording settings are used when collecting GNSS data in a "Kinematic" mode. The receiver can automatically log a point every X distance or Y seconds. The user simply selects what option they prefer to use for logging Kinematic data and start the survey. Keep in mind while collecting data at higher velocities that FieldGenius receives position updates from the GNSS at a maximum rate of once per second.

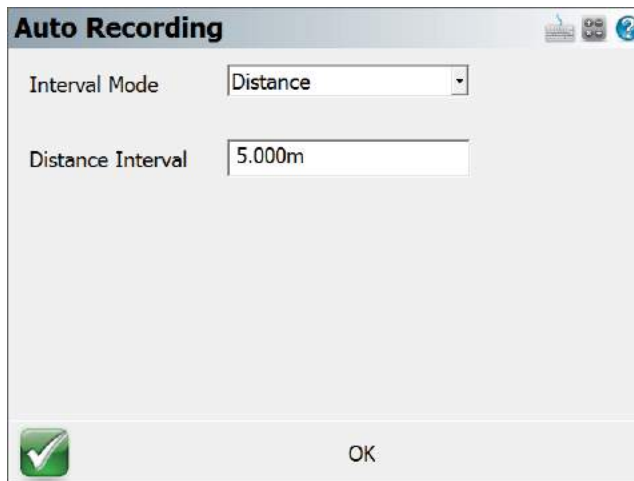

Once configured, Auto-Recording is activated on the [Rover Measure Mode](#) screen after pressing the Measure button:

Once activated, Auto-Recording is deactivated by pressing the Measure button again.

Staking

[Main Menu or Instrument Toolbar | Measure Modes | Staking](#)

See the [Staking](#) topic for more information.

Local Transformation Point

[Main Menu or GNSS Toolbar | Measure Modes | Local Transformation Point](#)

This Measure Mode is designed to quickly add control points to a **GNSS Local Transformation**, using the Similarity method by matching up control points. The procedure is as follows:

1. Set the **Local Transformation Point** Measure Mode:

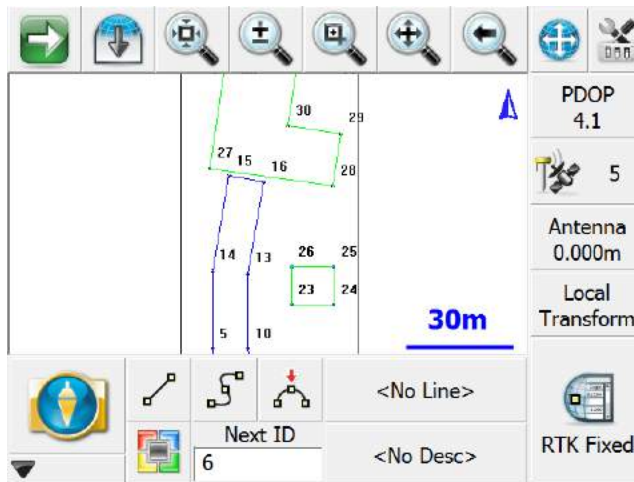

2. Measure a control point that you wish to use for your localization. You will have the choice to store the observation as a point in the database:
3. Specify whether the control point will be used for horizontal and/or vertical control, then pick **Select Existing** to set the local control point:

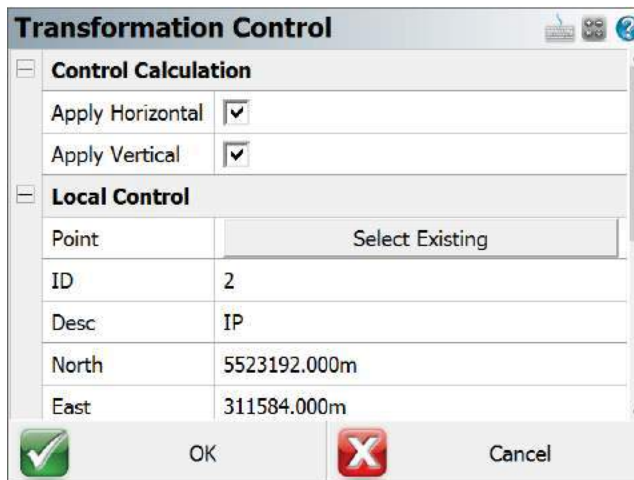

4. Optionally confirm the measured values for the GNSS Control Point:



5. Pick **OK** to accept the control pair.
6. Pick **OK** on the Transformation Control screen:

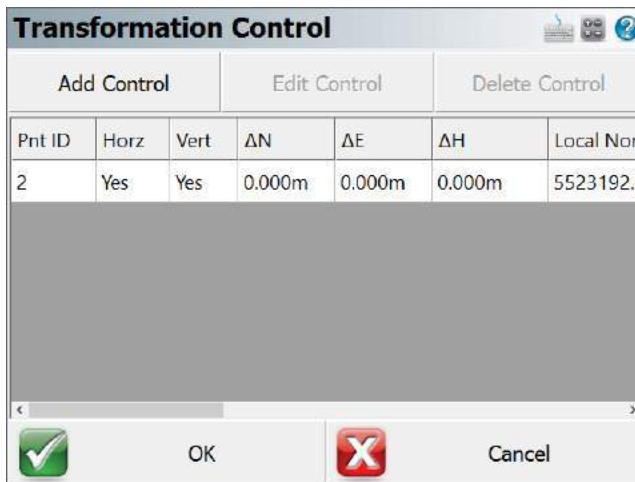

7. Repeat Steps 2-6 for any additional control points.
8. Review and apply the transformation, please see the [GNSS Local Transformation](#) topic for more details.

GroupCode

[Main Menu or GNSS Toolbar](#) | [Measure Modes](#) | [GroupCode](#)

Overview

GroupCode is a Measure Mode that allows the user to set up a Group of Codes that have a common theme or purpose, and is ideal to increase productivity for repetitive feature collection. GroupCode allows:

- Creating multiple groups of codes
- Setting a pattern to automate code selection for feature collection in a repetitive sequence (such as road cross sections)
- Linework toggles for each code in the group allowing linework to be automatically completed for each feature in the group as separate figures without any effort from the operator
- Switching between a carousel display combined with the Map screen, or a full-screen button panel with the codes in the group
- Fast switching between groups with settings retained for each group
- Fast switching between GroupCode and other Measure Modes and being able to resume collection within GroupCode with no additional steps

Operation Notes

For GNSS operation there is only one GroupCode Measure Mode. The GNSS [Tolerance Settings](#) will be honoured to determine if the observation is automatically stored:

- Auto Skip Meas Stat – This option in the Tolerance Setting determines if the measurement statistics are displayed during the measurement process
- Auto Store Meas – This option in the Tolerance Setting determines if the Store Point dialog will be displayed prior to storing an observation

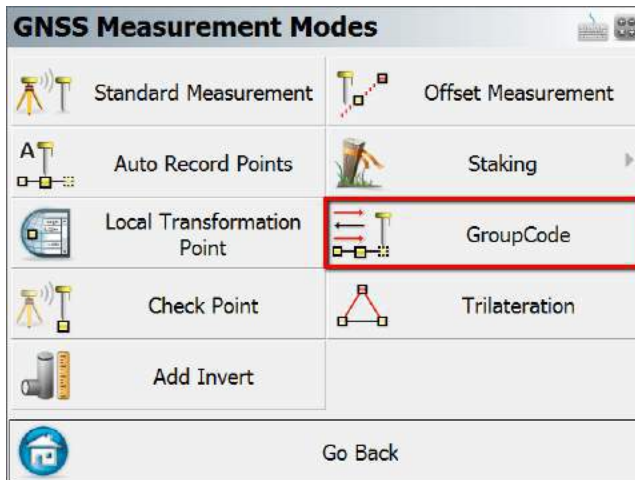

See the [GroupCode Editor](#) topic for information about setting up a group and changing its behaviours.

Workflow

The **GroupCode** feature is designed to allow fast measuring, and as such the automation of the code selection and multiple linework figures can reduce the task to a simple measurement button press. When no pattern is set, the user will manually need to select the next code to use, and line toggles will be necessary for drawing arcs.

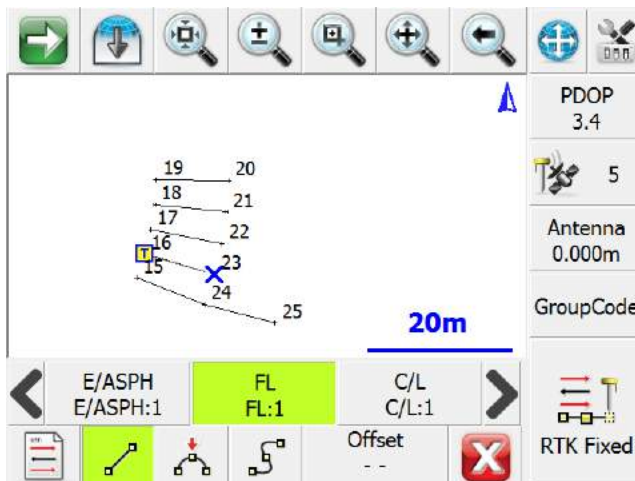

Entering Offsets

It is possible to pre-enter distance offsets that will be applied to the next measurement. The Offset button will display the offset directions that will be applied if the offsets are set. Direction, Horizontal Distance, and Vertical Distance.

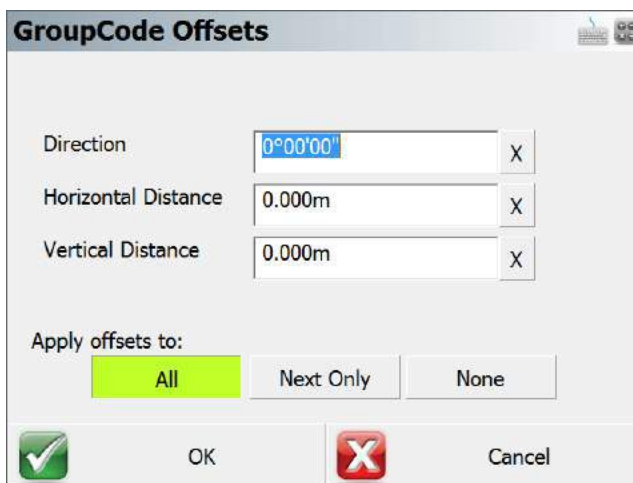

GroupCode Offsets

Direction X

Horizontal Distance X

Vertical Distance X

Apply offsets to:

OK Cancel

The offset entry screen has toggles that can be used to set the values:

- Field Value Resets, X next to field
- Apply offsets to All Measurements, Next Measurement Only, or None

Check Point

[Main Menu or GNSS Toolbar](#) | [Measure Modes](#) | [Check Point](#)

Use this to measure a check shot to an existing point. When you start the command you will see the point chooser appear where you can create a new point or pick an existing one from a list or from the screen. After you choose your point you will be ready to measure. You will note the Measure Mode will be set to **Check Pnt** and if you need to cancel the operation you can do it by pressing the Measure Mode button and choose to cancel it.

Check Point Summary

When you're ready to record the shot press the **Measure** button on the instrument toolbar. You will be presented with a screen that compares your measured values to the ones that were computed for the check shot point.



The deltas that are displayed are computed by subtracting the shot coordinates from the known coordinates. In other words if you add the deltas to the shot point coordinates you will end up at the known point.

Store Point

Pressing this will exit the function and write several notes to the raw file summarizing your check shot, and allow you to store the shot using the [Store/Edit Point](#) screen.

```
--Check Point
-- Check Point ID: 110
-- Check Point dNorthing: -4.59'
-- Check Point dEasting: -1.82'
-- Check Point dElevation: -4.96'
-- Check Point dHorizontal: 4.94'
-- Observed Values: HA 45°00'00.0" VA 90°00'00.0" SD 23.00' HR 5.00'
-- Observed Point Northing: 5016.26'
-- Observed Point Easting: 5016.26'
-- Observed Point Elevation: 95.00'
```

Close

This will exit the check shot function and not write anything to the raw file or storing a new point.

Trilateration

[Main Menu or GNSS Toolbar](#) | [Measure Modes](#) | [Trilateration](#)

This routine allows you to trilaterate the position of new points by observing their distances from two known positions. The two known points will make up a baseline, from which a distance-distance intersection will be calculated to determine the position of each new point.

The primary use of this routine is for GNSS users so they can locate inaccessible points. They can locate two points with GNSS, and then use the Trilateration routine to locate the inaccessible points.

This routine can accept distances measured with the Leica Disto.

New Pnt	Pnt 1 Dist	Pnt 2 Dist	Side	Saved

Static Points (Baseline)

Select your two baseline points, from which you will be observing the distances to the new points.

Add Point

Use this to add a new unknown point to solve for. When you press this, you will be prompted for the new point number and description, and whether it is on the left or right side of the baseline.

Add Trilateration Point

Point ID

Description

Baseline Side Left Right

OK Cancel

Save Point

This saves the selected New Point into your project.

Switch Side

This toggles the selected New Point to the Left or Right side of the baseline.

Map View

This takes you to a map view showing your baseline, the distance measured from each point, and the calculated position of the new point.

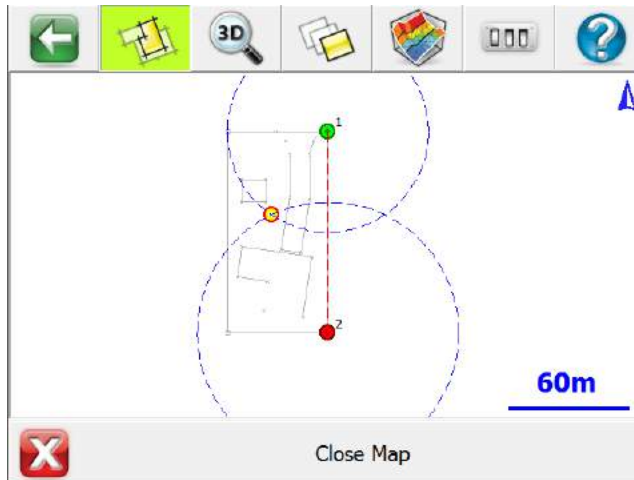

If desired, you can press the World View button on the [Display toolbar](#) to hide unnecessary data.

Measure from Point 1

Press this to record the distance from Point 1 of your baseline to the selected New Point.

Measure from Point 2

Press this to record the distance from Point 2 of your baseline to the selected New Point.

Add Invert

[Main Menu or GNSS Toolbar](#) | [Measure Modes](#) | [Add Invert](#)

If you've manually measured a distance to an invert, you can have FieldGenius compute a point with a computed invert elevation.

When you start the command you will see the Invert Toolbar appear towards the bottom of your main screen.



First you need to specify the point that will be referenced to compute the invert elevation. You can do this by using the point chooser button.

Now enter the measured distance to the inverse. For example if your measurement was 5.5', FieldGenius will subtract this from the reference point's elevation. Entering a negative value will cause it to be added.

Press **Store Point** to create and save a point with the calculated invert distance. This point will have the same northing and easting value as the reference point.

Note:

While the invert toolbar is open, you can continue entering invert measurements or choose different reference points.

Raw File

When you save the point, an offset and store point record will be created.

```
--OS,OP7,FP8,ND0.000,ED0.000,LD5.000  
SP,PN8,N 935.976,E 1232.356,EL5.000,--<No Desc>
```

Measure Modes (Disto/Laser)

[Main Menu or Instrument Toolbar](#) | Measure Modes

These are commands built into FieldGenius that will help you measure and map your points while connected to a supported Disto/Laser device. The desired Measure Mode must be selected before you begin a measurement.

For a faster way to get to this screen, you can also press the Measure Modes button which is located on the [instrument toolbar](#).

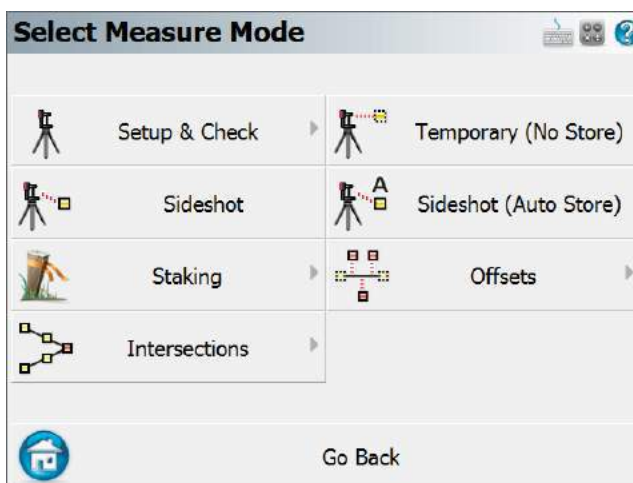

Note: Several of these modes will not be available until you have completed a setup.

Setup and Check

Quick Setup

Use this to perform a quick setup procedure, with the instrument on a point facing a certain direction. Please see the [Quick Setup](#) topic for more information.

Backsight by 1 Point or Direction

Use this to define an instrument setup. Same procedure as with a Total Station, please see the [Backsight Method](#) topic for more information.

Resection

This will start the multiple point resection routine to allow you to determine your current instrument position by measuring to known points. Same procedure as with a Total Station, please see the [Resection](#) topic for more information.

Backsight Baseline

Use this to define an instrument setup from the position and orientation of an arbitrary baseline. Please see the [Backsight Baseline](#) topic for more information.

Check Point

Use this to display a check measurement to an existing point in your Project. Same procedure as with a Total Station, please see the [Check Point](#) topic for more information.

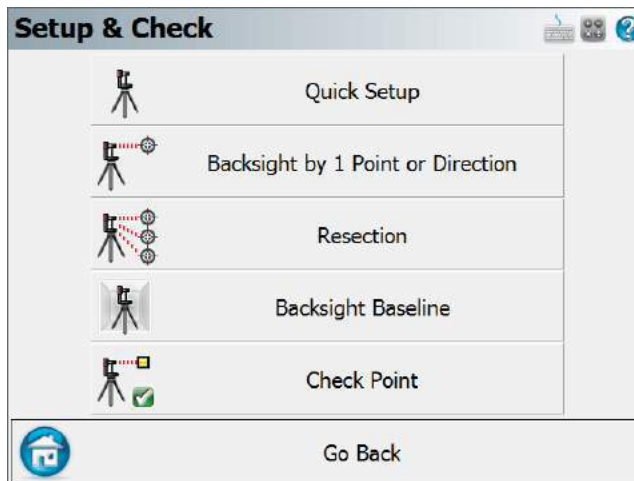

Temporary (No Store)

This will allow you to take a measurement without storing it. Same procedure as with a Total Station, please see the [Temporary \(No Store\)](#) topic for more information.

Sideshot

This mode allows you to measure a point. After the measurement, it will allow you to review your measurement data and allow you to make changes to the point ID and description before it is stored. Same procedure as with a Total Station, please see the [Sideshot](#) topic for more information.

Sideshot (Auto Store)

This mode allows you to measure a point using the next available point id, and the description and line toggles specified on the main map screen. Using this is a very fast method for recording your measurements. Same procedure as with a Total Station, please see the [Sideshot \(Auto Store\)](#) topic for more information.

GroupCode

This mode allows you to set up a Group of Codes that have a common theme or purpose, and is ideal to increase productivity for repetitive feature collection. Same procedure as with a Total Station, please see the [GroupCode](#) topic for more information.

GroupCode (Auto)

The GroupCode mode with automatic point storing using the next available Point ID.

Staking

Please see the [Staking Menu](#) topic for more information.

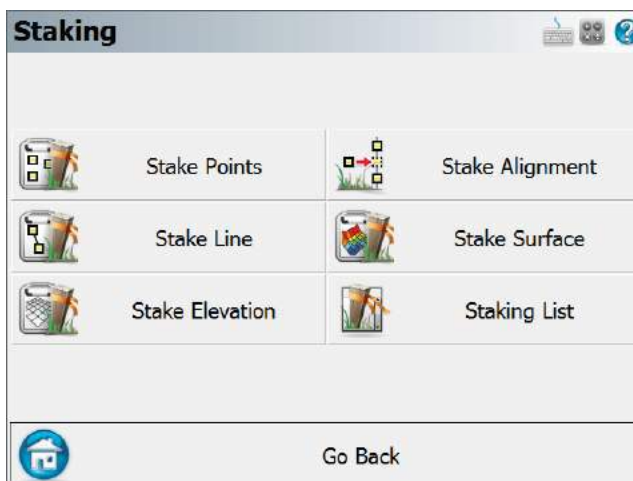

Offsets

Distance Offset

This will start the distance offset routine. Same procedure as with a Total Station, please see the [Distance Offset](#) topic for more information.

Horizontal Angle Offset

This will start the angle offset routine. Same procedure as with a Total Station, please see the [Horizontal Angle Offset](#) topic for more information.

Vertical Angle Offset

This will allow you to compute the height of an object. Same procedure as with a Total Station, please see the [Vertical Angle Offset](#) topic for more information.

Line - Distance Offset

This allows you to measure two points to define a baseline, then manually enter measured distances. These distances will be used to compute a new point based on the baseline. Same procedure as with a Total Station, please see the [Line - Distance Offset](#) topic for more information.

Add Invert

Use this to open the invert toolbar. You will then be able to record invert measurements. Same procedure as with a Total Station, please see the [Add Invert](#) topic for more information.

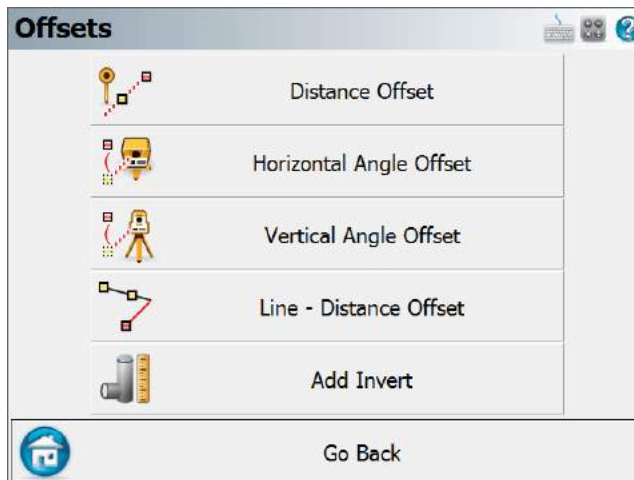

Intersections

Two Line Intersection

This allows you to measure two baselines and FieldGenius will compute the intersection point. Same procedure as with a Total Station, please see the [Two Line Intersection](#) topic for more information.

Line - Angle Intersection

This allows you to measure two points to define a baseline, measure an angle, and FieldGenius will compute the intersection point. Same procedure as with a Total Station, please see the [Line - Angle Intersection](#) topic for more information.

Line - Perpendicular Point

This allows you to measure two points to define a baseline, then you can select an existing point which will be used to compute a perpendicular intersection. Same procedure as with a Total Station, please see the [Line - Perpendicular Point](#) topic for more information.

Trilateration

This will allow you to compute new points by observing their distances from two known existing points. Please see the [Trilateration](#) topic for more information.

Vertical Plane Projection

This will allow you to compute points on a user defined vertical plane. Same procedure as with a Total Station, please see the [Vertical Plane Projection](#) topic for more information.

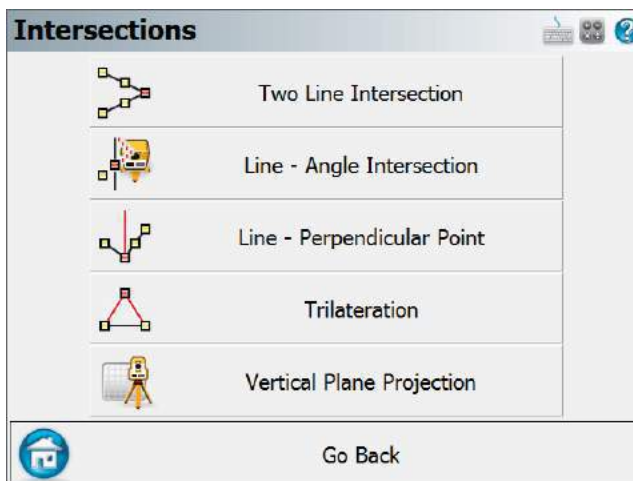

Quick Setup

[Main Menu or Instrument Toolbar](#) | [Measure Modes](#) | [Setup & Check](#) | [Quick Setup](#)

This setup procedure requires a Point and a direction to complete the setup.

Quick Setup

Station Information

Point ID

Instrument Height

Orientation

Set Direction

NORTH

WEST SOUTH EAST

Complete Setup Cancel

Point ID

Enter a Point ID to set the Station, or tap in the field to open a menu to pick a point from a list or map, or create a new point.

Instrument Height

Enter the height of the device above ground if you wish to reference it.

Set Direction

Enter the direction that the device is pointing, or pick on one of the four direction buttons to set the direction.

Complete Setup

Pick **Complete Setup** to finish. The direction will be captured and set as the orientation reference.

Backsight Baseline

[Main Menu or Instrument Toolbar](#) | [Measure Modes](#) | [Setup & Check](#) | [Backsight Baseline](#)

When setting up a total station or Disto in a room or outside at a Scene, in certain circumstances it is advantageous to define one of the room's walls as a baseline for the scene. Or outside to select a linear feature like a Sidewalk or curb.

Using this method ensures that your room or outside Scene coordinate system is oriented to a baseline plane you are defining for the site. This makes the Scene easier to work in FieldGenius and when imported into your desktop drawing program.

Another benefit to using this feature is that all points mapped with the total station will be referenced to the origin and baseline.

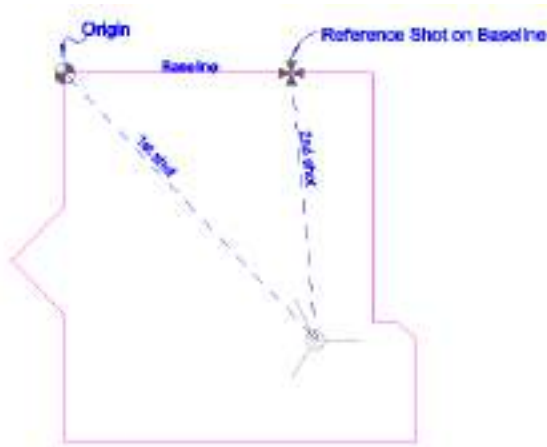

Function

Usually this feature will be used in a new Project, but it could be used in an existing scene if needed. In this example we will begin by creating a new scene.

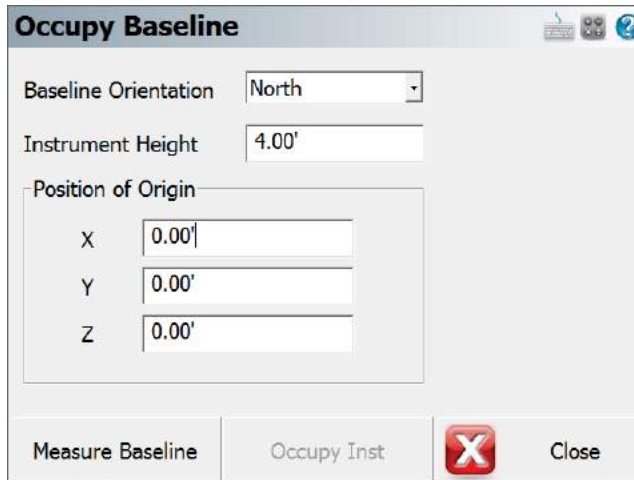

Occupy Baseline

Baseline Orientation: North

Instrument Height: 4.00'

Position of Origin

X: 0.00'

Y: 0.00'

Z: 0.00'

Measure Baseline Occupy Inst X Close

In the Occupy Baseline screen you need to specify the orientation of the baseline, your instrument height and the position that you want to use for the origin point.

Baseline Direction

This is the direction that you want the wall "baseline" to face in your Project. The direction that you use is totally up to you. You should pick a direction that will help you visually confirm that the points you're mapping are correct. If you refer to the image at the beginning of this document, the instrument was setup in the lower right corner of the room. From the instrument operator's perspective, it made sense to use a baseline set to East so the far wall would be horizontal along the X axis in the Project. If you look at the image of the Tracker at the beginning of this topic, you will see that using this feature makes the room align with your scene's coordinate system.

In the examples below, the same origin coordinates and total station measurement were used. The only thing that was different, was the direction specified for the baseline.

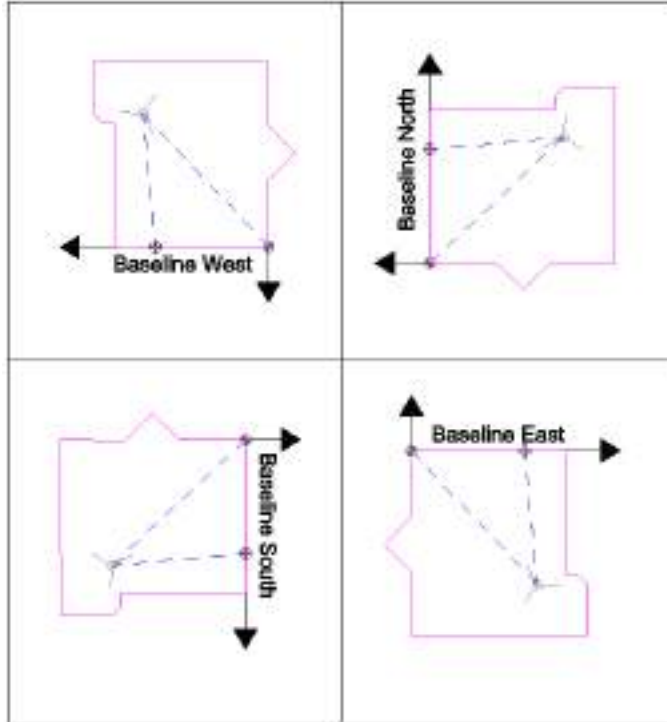

Position of Origin

The default coordinates are 0, but any value could be used. The origin will be located and defined by your first measurement.

Usually you will want the bottom corner of the wall to be equal to the z value you define. Assuming you're using a reflectorless instrument, if you can't see the bottom corner directly with the instrument, you can measure up the wall and mark a point a known distance from the floor. Then sight this point with your instrument, but make sure you define the distance you measured as your new target height. Otherwise, if no target height is specified, the location you measure at the corner will be the origin.

Measure Baseline

When you press this you will be required to measure two shots; one to define the origin and the other to define the location of the instrument in reference to the baseline.

How it Works

Using the origin, and the baseline direction you specified, a "baseline" is created.

Using the first shot, the instrument position cannot be accurately calculated yet. The instrument isn't referenced to the baseline yet, and hinges around the origin point.

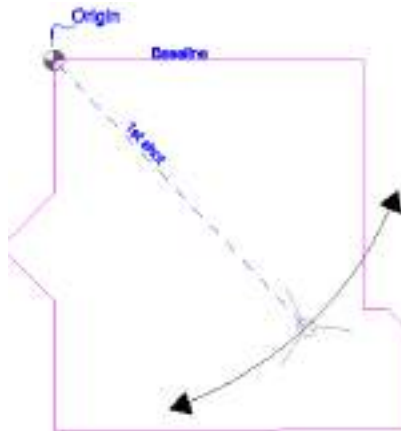

Then using the second shot, the total station location in the room can be accurately computed.

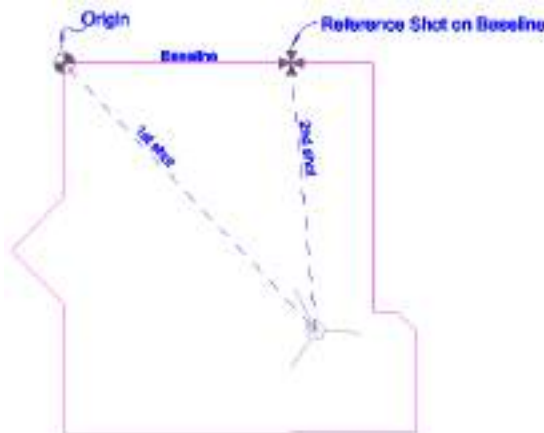

Store Reference (Occupy) Position

After you finish measuring the necessary measurement, you will be taken back to the Occupy Baseline screen.

You will now see that the Occupy Inst screen is enabled. Press this to accept your measurements and FieldGenius will store a new point for the reference point. Also, in the raw file Occupy point records will be recorded along with the measurements made on the wall.

```
--Occupy Room
--Baseline Direction: East
--N 0.0000,E 0.0000,EL0.0000,--Origin Pnt
--HI1.310,HR1.514,AR25.16100,ZE88.26290,SD7.0790,--Pnt for Origin
--HI1.310,HR1.514,AR63.18170,ZE88.26220,SD5.1750,--Pnt on Baseline
OC,OP1,N -5.1514,E 4.8516,EL0.0115,--RP
BK,OP1,BP0,BS316.42594,BC25.16100
LS,HI1.310,HR1.514
```

You are now ready to continue mapping your scene.

Survey Tools

[Main Menu](#) | [Survey Tools](#)

This menu contains functions pertaining to the data in your Project.

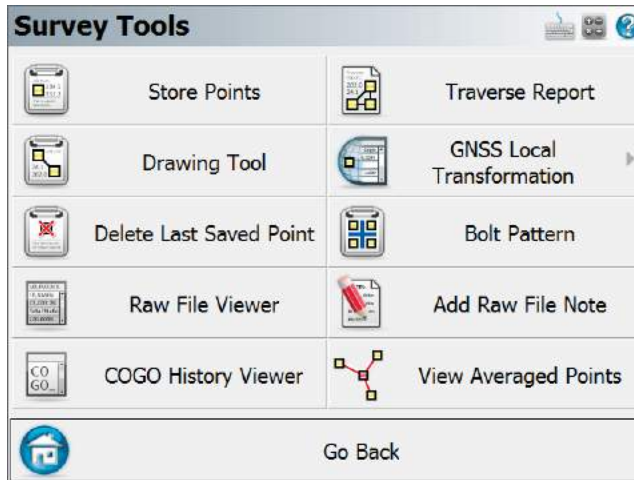

[Store Points](#)

Use this to enter new coordinates into your scene's database. Please see the [Store Points](#) topic for more information.

[Drawing Tool](#)

This starts up the [draw plan](#) tool.

[Delete Last Saved Point](#)

Use this to "delete" up to ten of the last points that were saved. Please see the [Delete Last Saved Point](#) topic for more information.

[Raw File Viewer](#)

Use this to open a viewer that will display your current raw file. Please see the [Raw File Viewer](#) topic for more information.

[COGO History Viewer](#)

Use this to display the results that were computed using the COGO commands. Please see the [COGO History Viewer](#) topic for more information.

[Traverse Report](#)

Use this to generate a traverse closure report based on your traverse setups. Please see the [Traverse Report](#) topic for more information.

[GNSS Local Transformation](#)

Use this to specify transformation parameters that can be used to localize GNSS data. Please see the [Transformation Setup](#) topic for more information.

[Bolt Pattern](#)

Use this to create and apply point patterns for example for bolt plates or pillars. Please see the [Bolt Pattern](#) topic for more information.

[Add Raw File Note](#)

Use this to add a comment to the raw file. Please see the [Raw File Comment](#) topic for more information.

[View Averaged Points](#)

Please see the [Point Averaging](#) topic for more information.

Store / Edit Points

[Main Menu](#) | [Survey Tools](#) | [Store Points](#)

This is a multi-use function that is used by many parts of the program. Essentially any time a point needs to be stored or edited, it will done via the store point screen. Depending on what it is you're doing, certain parts of the dialog will be disabled or not editable. Following is an explanation of what you should expect.

[Measured or Calculated Points](#)

Points that were measured or computed via any of our commands will automatically have their Survey Role set to **measured**. When these types of points are edited, only the description can be changed; the point id and coordinate values will be non-editable. The reason we do this is so the coordinates don't accidentally get altered. You can check a point's survey role by pressing the **Advanced** button. You can override this by changing the survey role type to "null".

Certain commands in FieldGenius are allowed to ignore the measured survey role, such as the Rotate/Translate/Scale command or the overwrite option that is triggered when you try to store a point using a point id that already exists in the Project.

Manually Entered or Imported Points

Point that have been manually entered or imported from an ASCII file for example, will have their Survey Role set to **null**. Points that have a Survey Role set to null can be edited except for the point id.

Point ID

Enter in the point number you would like to assign to the point. Note that by default it will display the next available point number. If you're editing an existing point, this field will not be editable.

Line/Spline/Arc Buttons



This is used to toggle on and off the draw lines function. When turned on as you shoot your points in the drawing they will be connected with a line. This button can only be used if you're storing a point after a measurement.



This is used to toggle on and off the draw curvy lines button. This function will draw a best-fit curve through your points as you shoot them. This button can only be used if you're storing a point after a measurement.



3-Point arcs can be started using the same method as for a Line or Curvy Line. This button can only be used if you're storing a point after a measurement.

Description

This is where you can enter a description for your point. This field is associated with your AutoMap library so as soon as you start typing in descriptions, a list appears displaying descriptions that match what you've entered. Simply press your **Enter Key** to accept your entry. You can also have FieldGenius notify you when the description you've entered isn't in your AutoMap library. To do this you need to make sure you have the **New Description Prompt** toggle turned on in the [Options](#) menu.

List Button

Press this to open the AutoMap Library screen. You will be able to choose the description that will be assigned to the point.

Northing, Easting, Elevation

Input your coordinate values in these fields when manually creating a new point using the add point function. If measuring a point, you cannot manually enter or edit coordinates.

Note Button

Press this to enter a note or record an audio note for the point. See the [Notes](#) topic for more information.

Prism Hgt (Height) / GNSS Hgt (Height)

When storing a point measured by a total station, you can set the Prism Height. When storing a point measured by a GNSS receiver, you can set the true or measured Antenna Height.

Review Measurement Button

This button is available when you have taken a measurement, and can be used to review the distance and angles measured.

GIS Attributes Button

If you loaded a feature list, then this button will be enabled. It allows you to access your [feature list](#) so you can edit feature attributes.

Store Pnt (point) Button

Press this to store the measured point.

Store SS (side shot) Button

Press this to store the point as a side shot. You would typically use this when not measuring traverse points. You will not see this button when measuring with GNSS.

Store TR (traverse) Button

Press this to store the point as a traverse point. You would typically use this when the measured point belongs to a traverse. You will not see this button when measuring with GNSS.

Cancel Button

Press this to cancel the measurement.

Advanced Button

Use this button to add or edit advanced tags to your point. You will mainly use this to help you distinguish points that are exported when you use the XML export.

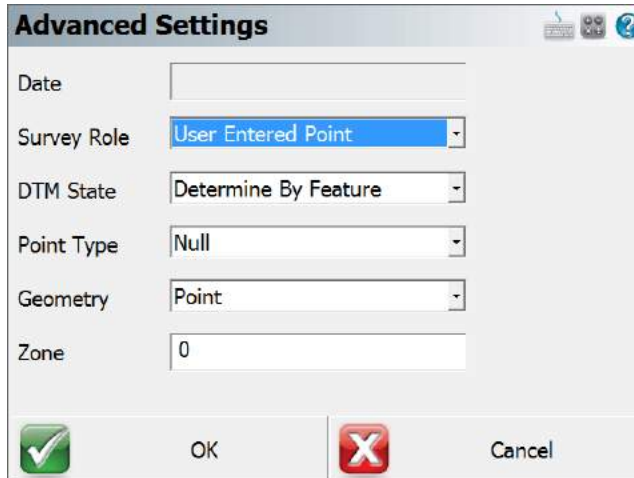

Advanced Settings

Date

Survey Role

DTM State

Point Type

Geometry

Zone

OK Cancel

Survey Role: Use this to edit the survey role for the point. By default points that are measured will have a role of **Measured**. Points with a **Measured** role type are read only when they're viewed with the store and edit screen. If you export an XML file, this information will be exported.

DTM State: Use this to choose the DTM attribute that will be written to the database file. **Determine By Feature** is the default value, if you don't want the point used in FieldGenius's modeling commands, you can set the DTM value to **Do not Include**. If you export an XML file, this information will be exported.

Point Type: Use this to enter a point type that will be written to the database file. If you export an XML file, this information will be exported.

Geometry: Use this to enter a geometry type that will be written to the database file. If you export an XML file, this information will be exported.

Zone: Use this to enter a zone number that will be written to the database file. If you export an XML file, this information will be exported.

Drawing Tool

[Main Menu](#) | [Survey Tools](#) | [Drawing Tool](#)

[Line Toolbar](#) | [Pencil button](#)

[Point Toolbar](#) | [Pencil button](#)

This tool allows you to quickly draw a plan such as a pad or a building footprint into your Project, and is typically used to recreate plans from a paper hard-copy. You can use this to either calculate new points, or to connect existing points that are already in your Project.

You must have at least one point in your Project before you can start, to define the starting position for your plan. If a point does not yet exist (for example if this is the first command you run in a new Project), you will be prompted to store a new point before you can proceed.

Line Mode

Use the Line draw mode to add straight line segments to your figure.

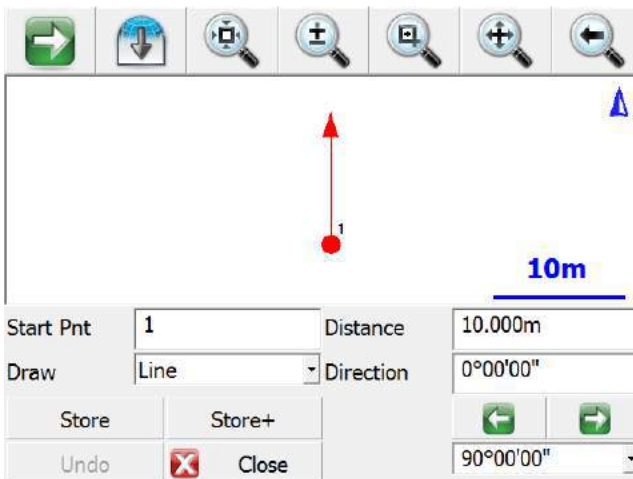

Start Point

Specify the start point for the new segment.

For starting a new plan, this should be set to an existing point in your Project, typically a corner that you will begin drawing the plan from.

As you continue adding subsequent points/segments to your plan, you will see the Start Point field automatically advance for you.

Distance

Specify the length of the line segment you wish to draw.

Direction

Specify the direction (Azimuth or Bearing) of the line segment you wish to draw. The easiest way to do this is to use the right/left arrow buttons, which will increment/decrement the direction value by the amount shown in the pulldown list below the arrows. You can select a common angle from the choices in the list (90, 45, or 30 degrees), or you can type any value if you need to increment it by some other amount.

Store

After you have defined the segment to add, press this to store the new point and line segment into your Project.

Store+

This does the same as the Store button, but you will see the [Store/Edit Point](#) screen. Use this to confirm or view the coordinates, or to specify a description.

Point by Line Mode

This is the same as the Line mode, except that when you press Store or Store+ it will only store the point, without drawing the line segment.

Arc Mode

Use the Arc draw mode to add arc segments to your figure.

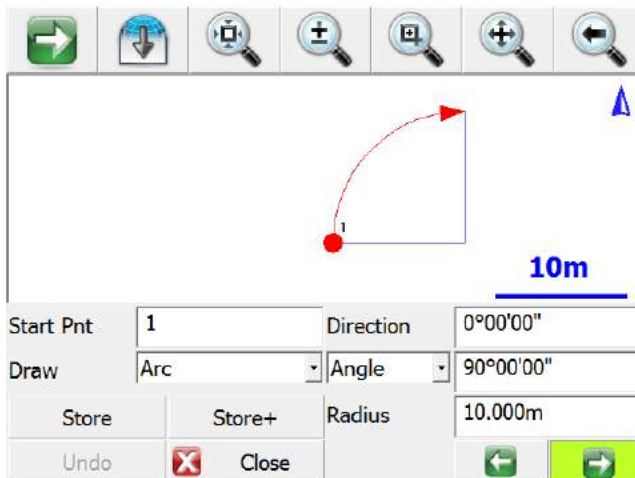

Start Point

Specify the start point for the new segment.

For starting a new plan, this should be set to an existing point in your Project, typically a corner that you will begin drawing the plan from.

As you continue adding subsequent points/segments to your plan, you will see the Start Point field automatically advance for you.

Direction

Specify the direction (Azimuth or Bearing) of the **tangent in** to the arc segment you wish to draw.

This will default to either the direction of the previous line segment or the tangent out of the previous arc segment, so as long as your arc is tangential to the previous segment you will not need to change this value.

Angle / Chord Length / Arc Length

Specify one of the three available methods to define your arc:

- Angle: Enter the interior delta angle of the arc.
- Chord: Enter the chord length of the arc.
- Arc: Enter the arc length of the arc.

Radius

Specify the radius to define your arc.

Clockwise / Counter-Clockwise Arrows

Use the Right/Left arrow buttons to define whether the arc rotates clockwise or counter-clockwise.

Store

After you have defined the segment to add, press this to store the new end and radial points, and draw the arc segment into your Project.

Store+

This does the same as the Store button, but you will see the [Store/Edit Point](#) screen. Use this to confirm or view the coordinates, or to specify a description.

Point by Arc Mode

This is the same as the Arc mode, except that when you press Store or Store+ it will only store the points, without drawing the arc segment.

Connect Points Mode

This mode lets you draw lines/arcs by connecting points that already exist in your Project.

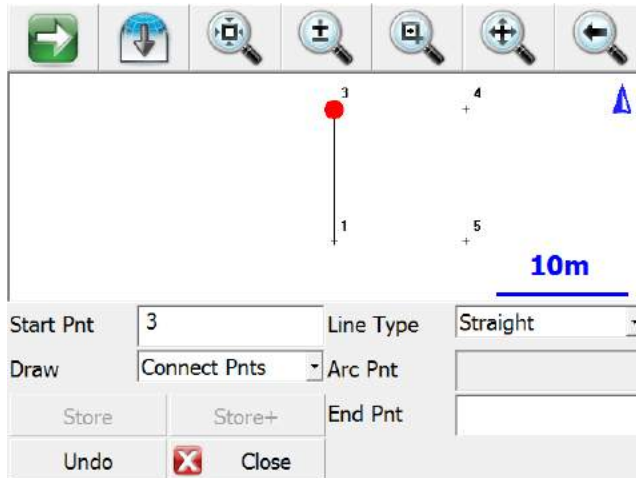

Start Point

Specify the start point for the new segment.

For starting a new plan, this should be set to an existing point in your Project, typically a corner that you will begin drawing the plan from.

As you continue connecting subsequent points to your plan, you will see the Start Point field automatically advance for you.

Line Type

Specify one of the five available methods to define your next figure segment:

- Straight: this will draw a straight line between the specified Start Point and End Point.
- Arc (CW): this will draw a clockwise arc between the specified Start Point and End Point, with the specified Radial Point.
- Arc (CCW): this will draw a counter-clockwise arc between the specified Start Point and End Point, with the specified Radial Point.
- Arc (3Pnt): this will draw an arc (clockwise or counter-clockwise) between the specified Start Point and End Point, going through the specified intermediate Arc Point (any point directly on the arc, does not need to be the midpoint).
- Spline: this will draw a curvy line between the specified Start Point and End Point.

Store / Store+

The Store and Store+ buttons are disabled for this mode, because new points are not being calculated for your Project. The line or arc segment will be automatically drawn into your Project after you specify its parameters.

Undo

Press the **Undo** button to undo the last segment you computed, removing both the point and/or the line segment (as appropriate) from your Project. You can undo multiple steps.

Note, there is no Redo function.

Close

Press the **Close** button to exit from the Draw Plan command, and you will be returned to the [map screen](#).

Delete Last Saved Point

[Main Menu](#) | [Survey Tools](#) | [Delete Last Saved Point](#)

Use this to delete the last point that was saved. When you delete a point, a record is written to the raw file indicating which point was deleted. You can only delete up to the last ten points that have been stored.

When you select the undo command, you will be asked to confirm that you would like to delete the last saved point.

Press **Yes** to undo.

Press **No** to cancel.

The point is now removed from the Project's map and database, but the original measurement data remains in the raw file.

Raw File

Using the example from above, this is what you will see in the raw file.

```
| SS,OP34,FP36,AR270.00000,ZE121.16010,SD2.5060,--TABLE  
| DP,PN36 |
```

The first line is the shot to point 36. The last line is a delete point record which is used to remove the point from the database.

Raw File Viewer

[Main Menu](#) | [Survey Tools](#) | [Raw File Viewer](#)

Use this button to open the raw file viewer. The raw file editor displays your scene's raw file and allows you to review it in an easy to read grid. For reference on the different raw file record types that FieldGenius uses you can refer to the [Raw File Record Types](#) topic for more information.

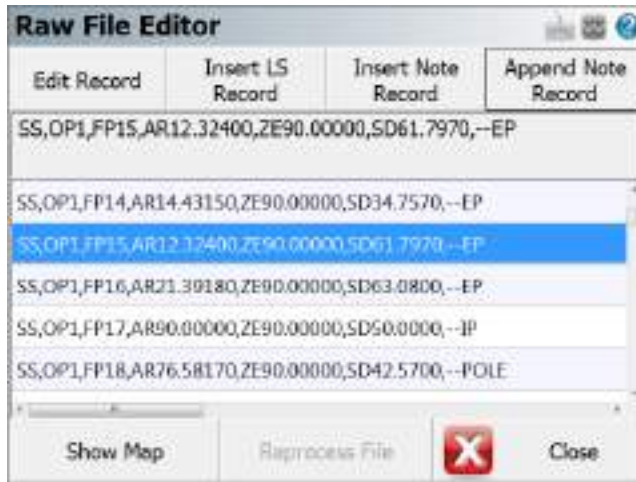

Edit Record

To edit a record simply tap the line in the raw file that has the record you want to edit. Then tap on the edit button to start editing the record.

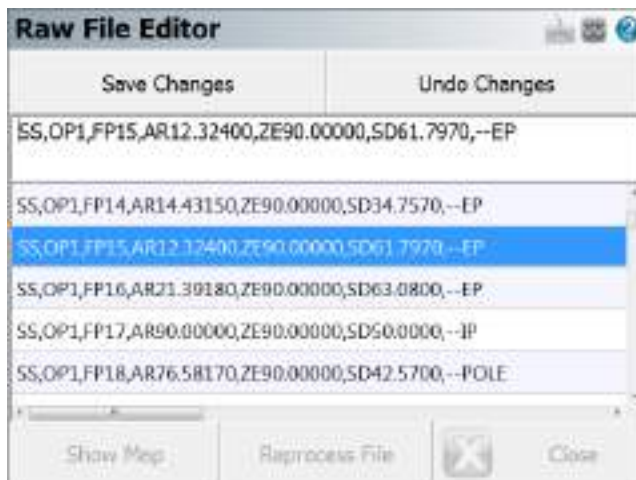

Save Changes: When you press the Save Changes button you will see the Raw File Edit screen which shows you the changes that will be made when you press the Yes button. Press No to cancel. After you press yes, the record will be changed and we will also write the original one to the raw file as a comment and it will be prefixed with the word "Edited".

Undo Changes: Undo will ignore your changes and return them to the original values.

Insert LS Record

The most common modification to the raw file is to insert a LS record. The LS record will be inserted above the highlighted row and a comment will be written as well to indicate that it was inserted.

Insert Note Record

This will allow you to enter a [comment](#). The comment will be inserted above the current line you have highlighted in the grid.

Append Note Record

This will allow you to enter a [comment](#). The comment will be appended to the end of the raw file.

Reprocess File

After you have made your changes you can re-coordinate the raw file so the changes are displayed on the screen and saved in the project database.

Note:

When you re-coordinate the raw file it will process the whole file from beginning to end. This means if you have changed the coordinate information for a point there is a chance that it will be changed back to its original value if it was measured and recorded in the raw file.

Show Map

This will change the raw file viewer to a split-screen display with a map view of your scene on half of the screen. When certain raw file records are selected, you will be shown the reference and backsight points, and the selected measurement record will be highlighted on the map.

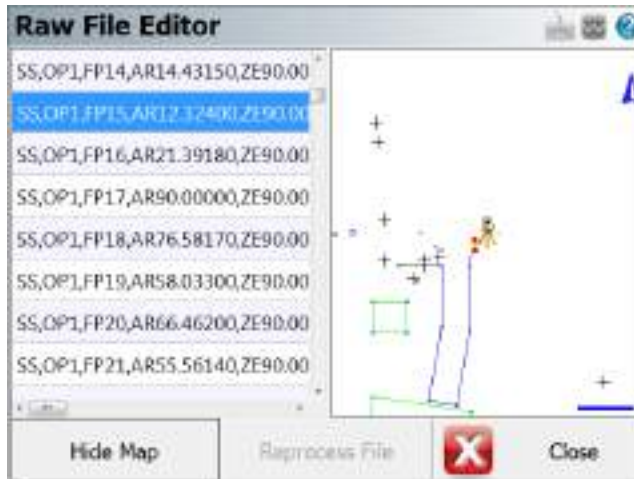

Raw File Backup

When you open the Raw File Editor a copy of the original raw file will automatically be made and saved in your project directory. The file will be named rawfile_bak#.raw, where the backup number increments with every backup file that is made. If you need to undo the changes you can close your project, re-open it and when the [Review Project Files](#) screen appears, use the raw file button to choose the backup file to load.

You can also exit FieldGenius and use a text editor to manually edit the names of the files.

COGO History Viewer

[Main Menu](#) | [Survey Tools](#) | [COGO History Viewer](#)

When you use the COGO history command a viewer will open displaying the results of your COGO calculations. This is a read only file and no changes can be made to it. The file is saved in your project directory and is saved as CogoCalcs.txt



Both the [Traverse / Intersect](#) and [Inverse](#) commands will save information to this file, as well as [Areas](#), [Volumes](#), and various other calculations.

The size of the text can be set to normal or large using the "Use large info text" option in the [program settings](#).

Traverse Report

[Main Menu](#) | [Survey Tools](#) | [Traverse Report](#)

Use this to compute a traverse closure based on traverse points you've measured and recorded. The traverse report scans your raw file for traverse records, which appear with a TR record type. You can save your shot as a TR record by choosing the TR button when the Measurement Info screen appears. TR records are also useful when you use the [Setup Occupy Point](#) function because your last TR shot will now become the current setup point and the BS point will be set to the last setup point for you automatically.

You can also balance your traverse using an angle, compass and vertical balance routine. See the [Traverse Adjustment](#) topic for more information.

The following examples will show you the traverse scenarios that FieldGenius supports. The open triangles depict known or computed points. TR records indicate all the foresight shots that were measured and recorded, and the OC record indicate the points that were occupied. Finally, the BK record indicates the point that was used for the initial backsight.

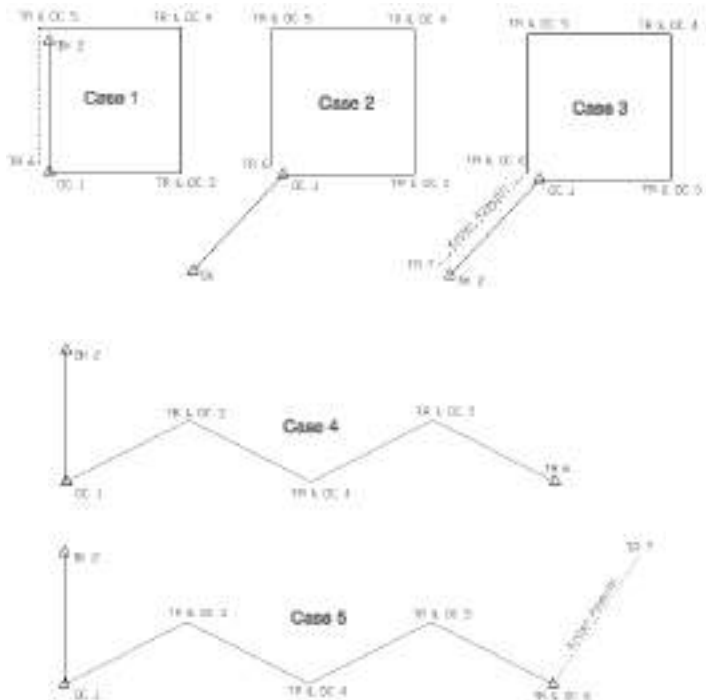

Traverse Definition (Foresight Method)

If we use CASE 1 as an example the user first setup on point 1 and backsighted point 2. He then foresighted and setup on points 3 to 5 and closed the traverse by recording one more TR record to point 6. To compute the traverse report you go to the Main Menu / Survey and choose the **Traverse Report** button. When selected, you will see the following screen.



The screenshot shows a dialog box titled "Traverse Definition". It contains a "Foresight Method" section with three radio button options: "Occupy point closes traverse", "Foresight point closes traverse" (which is selected), and "Foresight closes to direction". Below this are two input fields: "Foresight Compare Pnt" with the value "1" and "Occupy Compare Pnt" with the value "2". At the bottom, there are three buttons: a "View Report" button with a checkmark icon, a "Close" button with a red 'X' icon, and a small "Close" text label.

FieldGenius will automatically scan the raw file looking for the last TR foresight and the OC record that was used to measure the last foresight. It will then search for any point within a 3 meter radius and use it as the match or point that defines the original coordinates.

If more than one point is found in the 3 meter radius, it will use the one that is closest.

FieldGenius supports two closed traverse methods. Choose **Foresight Point Closes Traverse** if you want to do a "Text Book" traverse closure. If you choose the **Occupy Point Closes Traverse** method, FieldGenius will not use your last foresight observation and assumes that the original back-sight and occupy points are fixed. Choosing this method will close the traverse on the original back-sight point, not the original setup point.

When you press the **View Report** button you will see the traverse closure results.

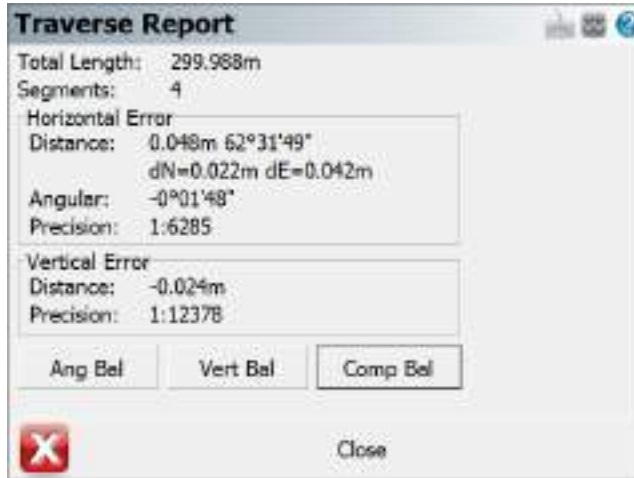

Total length

This is the total unknown legs that were measured in the field.

Segments

This is the total length traversed. Only unknown traverse legs will be added.

Horizontal Error

This is the horizontal closure and precision for your traverse. The closure direction is calculated from the known point to your measured point. If there isn't enough data to compute the angular error you will see the word "No Comparison" It also displays the delta northing and easting differences.

Vertical Error

This is the vertical error that is computed by comparing the elevations of the known point and measured closing point.

Traverse Definition (Foresight Method Bearing)

If we use CASE 3 as an example the user first setup on point 1 and backsighted point 2. He then foresighted and setup on points 3 to 6 and closed the traverse by recording one more TR record to point 7. To compute the traverse report you go to the Main Menu / Survey and choose the **Traverse Report** button. When selected, you will see the following screen.

Traverse Definition

Foresight Method

Occupy point closes traverse

Foresight point closes traverse

Foresight closes to direction

Last traverse foresight at 69.

Foresight Bearing

Last traverse occupy at 66.

Occupy Compare Pnt

View Report
 Close

FieldGenius will automatically scan the raw file looking for the last TR foresight and the OC record that was used to measure the last foresight. It will then search for any point within a 3 meter radius and use it as the match or point that defines the original coordinates. If more than one point is found in the 3 meter radius, it will use the one that is closest. In the **Foresight Bearing** field, enter in a known Bearing. When you press the **View Report** button you will see the traverse closure results.

Raw File

Several comments will be written to the raw file with the traverse report results for both Traverse Definition types.

```

--Traverse Report
-- Total Length: 600.10'
-- Segments: 3
-- Foresight control point: 1
-- Occupy control point: 2
-- Horizontal Distance Error: 0.10' 286°13'38"
-- Horizontal Angular Error: 0°00'30"
-- Horizontal Precision: 1:5762
-- Vertical Distance Error: 0.00'
-- Vertical Precision: No Error

```

Closing the Traverse (No Backsight Prism)

For closing the traverse, sometimes you may want to measure a closing angle and compare it to your previous backsight point or to a user entered bearing. For the traverse closure we need to store a TR record in the raw file and because of this a point needs to be computed. If you can't measure a distance to a prism you can use the [Manual Distance](#) Measure Mode which will record the plate reading from your instrument and prompt you to manually enter in a distance. Type in an arbitrary distance and a closing TR record will be computed.

Traverse Rules

- All [Measure Modes](#) on the [instrument toolbar](#), except for Sideshot (Auto Store), can be used to create TR records.
- The occupy point routine will be updated so the current setup is equal to your last TR shot, and backsight is equal to your last setup. You also need to do a setup directly after you shoot your TR record if you want to do "leap frog" traversing.
- You can have multiple traverses in the same raw file. To start a new traverse, you need to make sure the first setup point for the traverse isn't referenced in the raw file with a TR record. The most current traverse that you're working on will be used in the traverse computations.
- Only one TR record is allowed per setup.
- If you're importing your project into MicroSurvey CAD or inCAD we will automatically recognize your traverse points and create Station "traverse" setup for you in the MicroSurvey CAD or inCAD traverse file.

Traverse Adjustment

[Main Menu](#) | [Survey Tools](#) | [Traverse Report](#)

FieldGenius is capable of performing a traverse balance. You can adjust the traverse using a vertical, angle or compass balance. You can select any one of the three adjustment types or apply all three of them to the traverse.

The traverse routine uses traverse TR records in the raw file to define the traverse points that will be used for the adjustment. Please refer to the [Traverse Report](#) topic for more information on creating a traverse loop with FieldGenius.

When FieldGenius computes an adjustment it will write to the RAW file AP records with the new calculated coordinates for the traverse points.

FieldGenius will adjust the sideshots after you perform an adjustment. FieldGenius will scan the raw file from the beginning and re-process all setups (OC records) and sideshots (SS records).

Once you have completed your traverse and you would like to adjust it you need to do the following.

1. Define the closing points using the [Traverse Report](#) screen.
2. Compute the closure by pressing the **View Report** button.
3. Review the closure report confirming its validity.
4. Apply an adjustment using the **Ang Bal**, **Vert Bal**, or **Comp Bal** adjustment buttons at the bottom of the traverse report screen.
5. When you choose one of the adjustment types, you will be asked to confirm that you want to go ahead with the adjustment.
6. If you press Yes in the step 5, FieldGenius will adjust the traverse points and create AP records in the raw file. It will then re-process the raw file to re-compute the sideshots.

GNSS Local Transformation

Overview

Due to a variety of reasons, it may be necessary to adjust position coordinates for distortions which can include scale, rotation, translation in northing and translation in easting. The flexibility of FieldGenius's local transformation utility allows it to be used for a variety of applications and applied to positions derived from GNSS or terrestrial observations. For GNSS applications there are two possible reasons for the need of a transformation:

1. Translating from Local System to Plan System

GNSS receivers by default generate geodetic coordinates (latitude, longitude and ellipsoidal height) and the process of converting to Cartesian coordinates (northing, easting and orthometric height) or local system is done with existing well defined map projection systems such as Universal Transverse Mercator (UTM) or the State Plane Coordinate System (SPCS). Selection of the map projection in FieldGenius is done within the Datum page of the GNSS Configuration and a local zone is selected to minimize scale and meridian convergence distortion. Most land, boundary or property surveys are unique with regards to their generalized plane and coordinate origin for each Project. The coordinate system for these surveys is often referred to as a plan system with coordinate magnitudes being kept small for ease of recording and calculations. The majority of Projects can suffice with a simple translation in northing and easting to produce plan system coordinates from GNSS determined local system coordinates. The translation is easily determined by comparing a plan system coordinate and a local system coordinated for a single point.

2. Consideration for Scale and Rotation

Projects with larger extents need to take into consideration the curvature of the earth's surface which can be handled by the application of scale and rotation transformations plus the previously mentioned translations. In the case of mixing GNSS observations and terrestrial observations it does become important to apply a transformation, especially in scale, due to the fact that there is a difference in distance between positions measured on the ellipsoid and the terrain surface. As seen in Figure 1, coordinates derived from GNSS are always referenced to the surface of the ellipsoid as per the application of map projections. When the two points on the ellipsoid are projected upwards along the ellipsoid normals onto the earth's surface, they diverge, and a terrestrial distance observed between the points will be greater than the computed distance of the same two points on the ellipsoid. The effects of this zenith divergence becomes more evident as distance between the two points becomes greater and for larger terrain heights above the ellipsoidal surface.

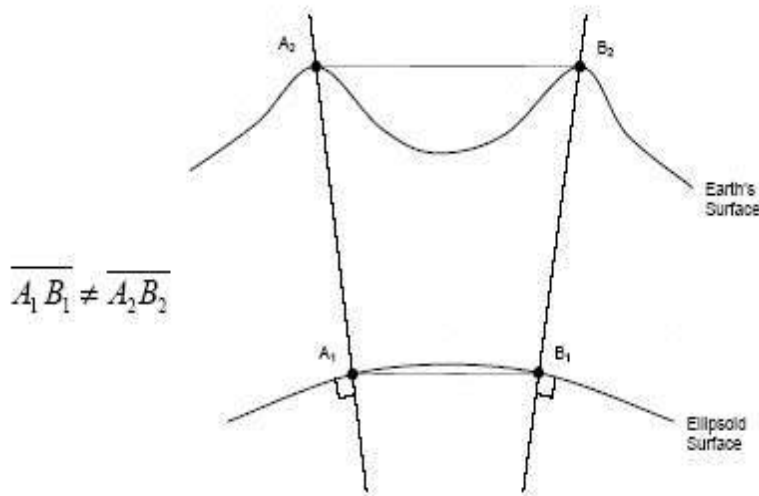

Figure 1. Divergence of Ellipsoid Normals.

Transformation Concepts

In order for the transformation parameters to be resolved, a sufficient number of control points are required with coordinates in both the plan system and local system. The determination of a four parameter transformation (two translations, scale and rotation) on a horizontal plane requires at minimum two physical points with each having two sets of corresponding coordinates as illustrated in Figure 2. Points A1 and B1 exist in what is termed the local system and are transformed into the plan system points of A2 and B2. The use of more coordinate observations will provide redundancy and the means to identify outliers for elimination. Solving for over constrained parameters is done with the application of least squares to provide the most rigorous minimization of residuals. Once transformation parameters have been resolved, newly observed or existing coordinates can easily be converted to the plan coordinate system.

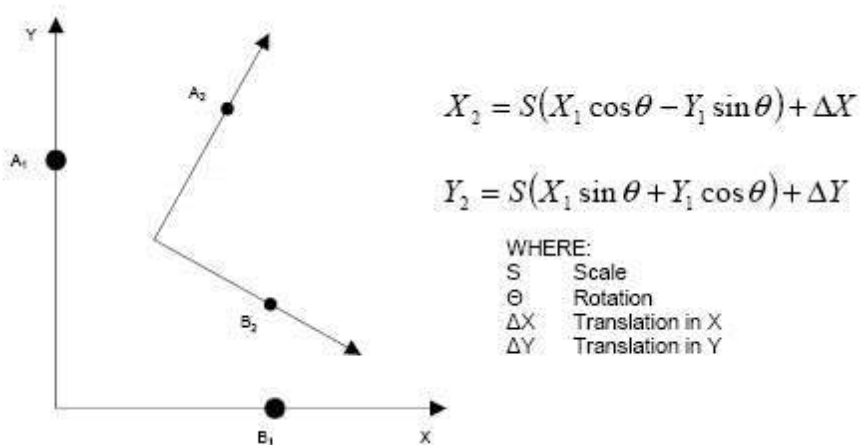

Figure 2. Horizontal Four Parameter Transformation.

The selection of control points for determining the transformation parameters are critical in reducing a colinearity condition along a particular axis. Colinearity will present itself if the control points are concentrated in a linear fashion as shown in Figure 3 (Poor Design) and thus weaken the parameters in a perpendicular direction. Control points should extend to the corners of the Project boundary and be extended with equal distances in both horizontal directions.

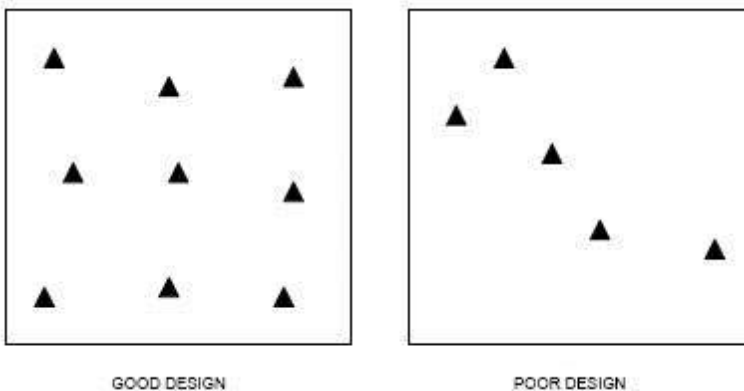

Figure 3. Transformation Control Design.

Vertical Transformation

The vertical transformation function of FieldGenius operates independently of the horizontal transformation. A sloped plane is calculated from the residuals of the constrained point pairs to determine a vertical bias, slope in X and slope in Y. To determine a vertical bias at least one point pair must be constrained and for all three parameters to be determined at least three point pairs must be constrained.

The use of the vertical transformation function should be restricted to cases where a geoid model is not available or there is a known problem with an existing geoid model.

Transformation Setup

[Main Menu](#) | [Survey Tools](#) | [GNSS Local Transformation](#)

Starting a new transformation, the following options will be available:



Modify Parameters

The Modify Parameters page allows the user to set the transformation method and parameters. This is always the first step of any local transformation. See the [Modify Parameters](#) topic for more information.

Import Parameters

FieldGenius has the ability to read in a localization file (*.loc) to apply a previously used transformation to the current Project. Select this button and navigate to the desired .loc file to load it in. There is no need to export the .loc file as it is automatically updated during the transformation routine.

Reset Parameters

Use this option to reset any previously applied transformation parameters. This cannot be undone.

NOTE: Depending on what the user specifies at the "Modify Parameters" page, additional options may become available:

Modify Control

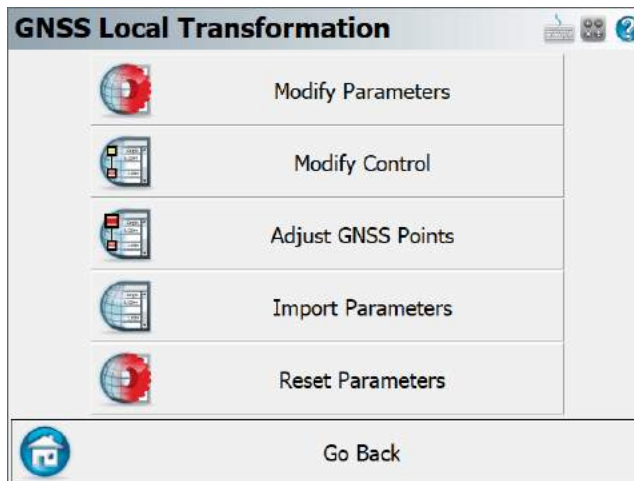

Only applicable for a "Similarity" method where the parameters are calculated by matching up control points. This option can be used to add, edit or delete control pairs used for the calculation of the transformation parameters. See the [Modify Control](#) topic for more information.

Adjust GNSS Points

When the transformation parameters are finalized, this option can be used to update the coordinates of every GNSS measured point in the database. The transformation parameters are always applied to the original Lat/Long of the measured point, to compute the adjusted grid coordinates.

Modify Parameters

[Main Menu](#) | [Survey Tools](#) | [GNSS Local Transformation](#) | [Modify Parameters](#)

The first step of a transformation is to specify the method to use: **None**, **Similarity** or **Helmert**. Depending on your selection, different input will be required.

None

For this method, the only input required are the [Scale Parameters](#).

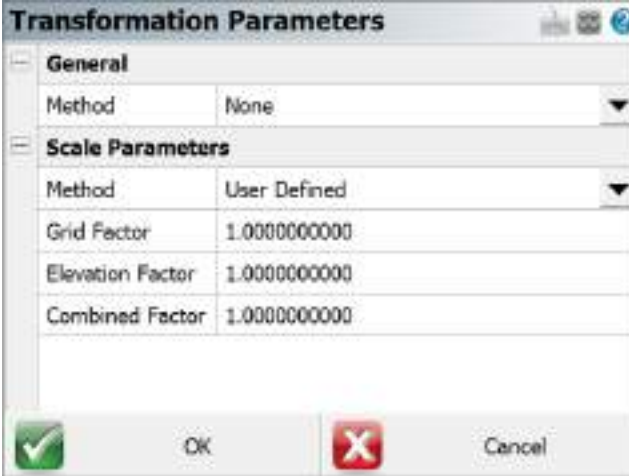

Transformation Parameters	
General	
Method	None
Scale Parameters	
Method	User Defined
Grid Factor	1.0000000000
Elevation Factor	1.0000000000
Combined Factor	1.0000000000

Similarity Method

Similarity transformation parameters can be calculated from control points, or manually defined:

- **Calculate Using Control** - Requires control points to be measured with GNSS.
 - An option exists to Calculate Slopes. This option should only be used if you do not have a geoid model to use for your vertical datum and you need your transformation to align well with the orthometric heights of your local control points. Use this feature with care as it can cause distortions in your elevations if it is used incorrectly.
 - An option exists to Calculate Scale. Disabling this option will ensure that no scale is calculated from the control points and the user may want to enter a pre-determined scale in the **Scale Parameters** section. When this option is enabled, the **Scale Parameters** should not be manually defined.
- **Manually Define** - Requires previously determined transformation parameter values. The user enters the Origin and Translate Point coordinates, Rotation, Scale Factor, Height Translation and Slopes.

Transformation Parameters

General

Method	Similarity
Parameters	Calculate Using Control
Calculate Scale	<input checked="" type="checkbox"/>
Calculate Slopes	<input checked="" type="checkbox"/>

Similarity Parameters

Origin North	0.000m
Origin East	0.000m
Translate North	0.000m

OK Cancel

Transformation Parameters

General

Method	Similarity
Parameters	Manually Define
Parameters	Press to Reset

Similarity Parameters

Origin North	0.000m
Origin East	0.000m
Translate North	0.000m
Translate East	0.000m

OK Cancel

Helmert Method

This method allows the user to manually enter the 7 Parameters of a Helmert Transformation (Translation X, Y and Z, Rotation X, Y, and Z, and Scale). These parameters will usually be pre-computed and/or published.

Transformation Parameters	
General	
Method	Helmert
Parameters	Press to Reset
Helmert Parameters	
Tx (mm)	0.0
Ty (mm)	0.0
Tz (mm)	0.0
Rx CCW (mas)	0.000
Ry CCW (mas)	0.000
<input type="checkbox"/> OK <input type="checkbox"/> Cancel	

Scale Parameters

The Scale Parameters can be:

1. **User Defined** - Manually enter the Grid Factor and Elevation Factor to determine the Combined Factor.
2. **Select From Database** - Pick a point from the database that was already measured with GNSS and stored. The Combined Factor of the point will be calculated.
3. **Measure GNSS Position** - Use the current position of the rover to calculate a Combined Factor.

NOTE:

In all cases the entered or calculated Combined Factor will be the inverse of the Combined Factor typically seen published or otherwise calculated.

The standard expression of the typical Combined Factor is:

Grid Distance = Ground Distance * Combined Factor.

We can refer to this as the "Ground to Grid" factor.

FieldGenius expects the "Grid to Ground" Combined Factor, which is the inverse of the typical Combined Factor.

NOTE: The transformation parameters are immediately applied to your current position and written to the Project's *.loc file when you confirm the values with **OK**.

Modify Control

[Main Menu](#) | [Survey Tools](#) | [GNSS Local Transformation](#) | [Modify Control](#)

Use this option to Add, Edit and Delete control points used to calculate the Similarity Transformation parameters.

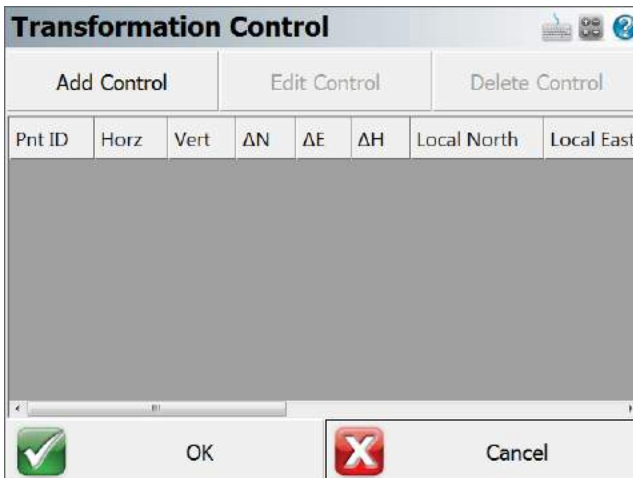

Add Control

Pick **Add Control** to match a Local Control point with a GNSS Control point. Control points can be matched 1D, 2D or 3D.

Transformation Control

Control Calculation

Apply Horizontal

Apply Vertical

Local Control

Point	Select Existing
ID	8
Desc	CP1
North	5523079.316m
East	311585.161m

OK Cancel

Transformation Control

East	311584.000m
Elev	100.000m

GNSS Control

Point	Select Existing
Point	Measure
Format	Geodetic
Latitude	N49°49'49.54496"
Longitude	W119°37'12.58931"
Height	381.869m

OK Cancel

- The Local Control section only allows the user to select an existing point from the database.
- The GNSS Control section allows the user to select an existing point from the database (must have been previously measured with GNSS) or to measure a position which can then optionally be added to the database.

Transformation Control	
East	311592.832m
Elev	100.000m
GNSS Control	
Point	Select Existing
Point	Measure
Format	Geodetic
Latitude	N49°49'49.10272"
Longitude	W119°37'13.63677"
Height	383.211m
 Cancel	

Edit Control

Select a row and then pick **Edit Control** to modify any component of a matched pair. For example, after reviewing the residuals of all the control points, it may be necessary to change a 3D match to a 2D match. The calculated parameters are immediately updated.

Delete Control

Select a row and then pick **Delete Control** to completely remove a control pair from the list. The calculated parameters are immediately updated.

Continue to add/edit/delete control until you are satisfied with the residuals. When done; press the **OK** button to take you back to the main GNSS Local Transformation dialog.

NOTE: The transformation parameters are immediately applied to your current position and written to the Project's *.loc file when you confirm the values with **OK**.

To complete the transformation and update previously measured GNSS points, pick the **Adjust GNSS Points** option.

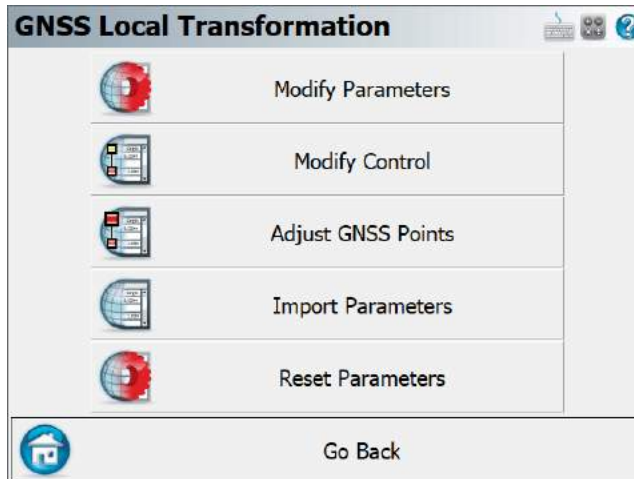

Bolt Patterns

[Main Menu](#) | [Survey Tools](#) | [Bolt Pattern](#)

This routine allows you to create or edit point patterns, and apply them to existing points in your project. This is useful for creating drill holes for bolt patterns, pillar columns, etc.

Note

The *.pattern data files are completely interchangeable between both FieldGenius and MicroSurvey CAD or inCAD, so any patterns created in one program can be edited or used in the other.

Pattern Toolbar

When you start the Point Pattern command, you will see the Pattern Toolbar along the bottom of your map screen.

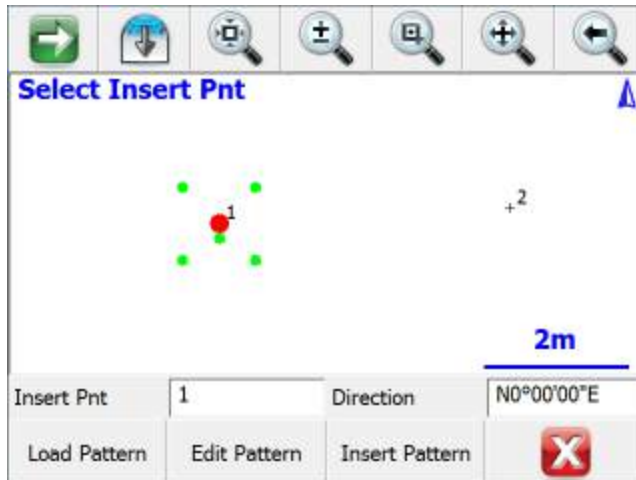

Insert Pnt

Specify the point ID for an existing point in your project, either by typing in its point ID, or by tapping on a point in the map screen to select it when this field has focus.

The selected point will be highlighted in the map view with a large red point, and the current pattern will be previewed with smaller green points.

Direction

Use this to specify a direction value for your pattern. The default direction of N0°00'00"E will orient the pattern exactly as it was defined.

To orient your pattern along any arbitrary line between two existing points, enter those two points using the pt#..pt# format like 1..2 and the direction between those two points will be automatically calculated for you. The pattern's X-axis will be applied along this direction.

Load Pattern

Press this button to load a previously saved *.pattern file.

Edit Pattern

Press this button to edit the currently loaded pattern, or to create a new pattern if you have not loaded one. Please see below for more information on the Pattern Editor.

Insert Pattern

Press this button to apply the currently pattern to the selected insertion point. New points will be stored in your project at the coordinates, as previewed by the green pattern points. All inserted points will be created with the description "Pattern", and with the same elevation as the selected insertion point.

To insert a pattern onto multiple points, simply change the insertion point and insert the pattern onto each point one-at-a-time as desired.

Pattern Editor

When you press Edit Pattern on the Pattern Toolbar, you will see the Pattern Editor screen.

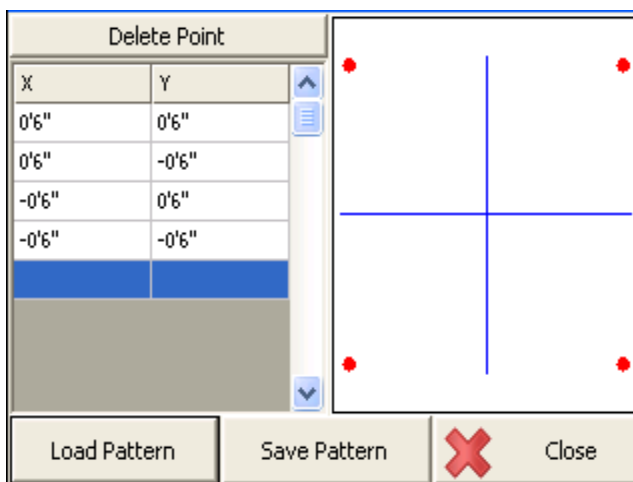

Enter the X and Y offset values for your pattern as desired. As you enter the points, they will be previewed in the grid, which will automatically zoom to the extents of your pattern. Please see the [Distance Entry & Recall](#) topic for options on entering the offset values in various units.

The 0,0 origin will always be located at the selected Insertion Point, so a point should not be included in your pattern at 0,0. You can also rotate the pattern into any orientation on the Pattern Toolbar (see above), so you do not need to create different variations of the same pattern to insert it in different orientations.

Press the Delete Point button to remove the selected X,Y offset from the pattern.

Load Pattern

Press this button to load a previously saved *.pattern file.

Save Pattern

Press this button to save the current pattern to disk.

This will always do a "Save As" type save, so you can specify a new filename, or select any existing pattern file to overwrite it with the changes. You will always be prompted for confirmation before overwriting an existing pattern file.

New Pattern

To create a new pattern, simply delete all of the existing points from the current pattern. When you press the Save Pattern button you will always be prompted for a new filename, so you will not lose the previous pattern.

Close

Press this button to close the Pattern Editor and return to the Pattern Toolbar. If you have not saved the current pattern, you will be prompted to confirm this before discarding your changes.

Add Raw File Note

Shortcut Key - X

At any time you can enter a note that will be recorded to the raw file. Simply press the X key on your keyboard device which will open the Enter Comment dialog. Enter a comment that you want appended to the end of your raw file. You are limited to 99 characters.

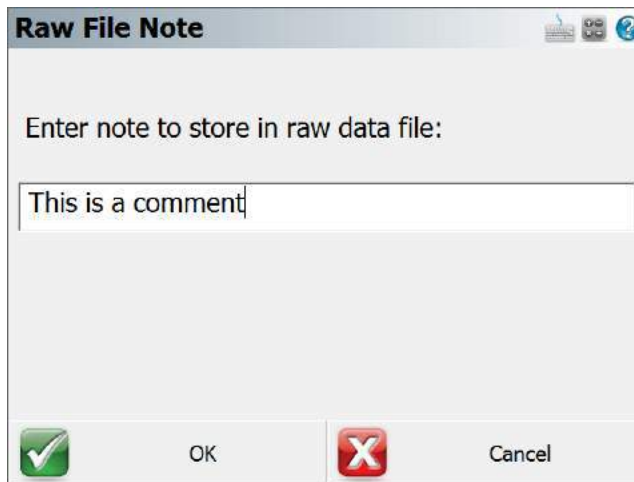

If you view your raw file your comments will appear as shown in the following example.

| --This is a comment |

You can also enter comments into the raw file by using the [Raw File Viewer](#).

View Averaged Points

[Main Menu](#) | [Survey Tools](#) | [View Averaged Points](#)

Please see the [Point Averaging](#) topic for more information.

Calculations

Main Menu | Calculations

The calculation menu contains calculation based functions that can be used to compute points, lines and other data.

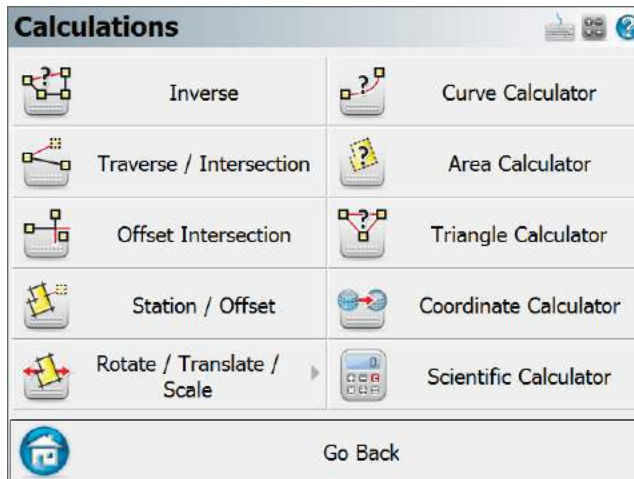

Inverse

Use this to inverse between points. Please see the [Inverse](#) topic for more information.

Traverse / Intersection

This will open the Traverse / Intersect toolbar. You can enter in directions and distances and perform common intersections such as bearing / bearing, distance/distance and many more. Please see the [Traverse / Intersection](#) topic for more information.

Offset Intersection

Use this to compute points that are located at computed intersections and offsets. This is essentially a bearing-bearing intersection, but you can specify offsets. Please see the [Offset Intersection](#) topic for more information.

Station / Offset

Use this to compute points at pre-defined stations and offsets. You can also use this to display the station and offset of existing points. Please see the [Station / Offset](#) topic for more information.

Rotate / Translate / Scale

Use this to compute coordinate shifts based on rotation, translation and scale parameters. Please see the [Apply User Defined Parameters](#) topic and the [Apply Control Calculated Parameters](#) topic for more information.

Curve Calculator

Use this to open a curve calculator. You define the values that you know, enter them, and then the remaining unknowns will be computed. Once you compute these values you have the option of storing the PT and Center points. Please see the [Curve Calculator](#) topic for more information.

Area Calculator

Use this to compute areas using points or lines in your project. You can also use this to compute pre-determined areas. Please see the [Area Calculator](#) topic for more information.

Triangle Calculator

Use this to compute a triangle solution using known angles or distances. Please refer to the [Triangle Calculator](#) topic for more information.

Coordinate Calculator

Use this tool to help you convert Geodetic coordinates to Cartesian coordinates. Please refer to the [Coordinate Calculator](#) topic for more information.

Scientific Calculator

Use this to display the RPN calculator. Please see the [Calculator](#) topic for more information.

Inverse

[Main Menu](#) | [Calculations](#) | [Inverse](#)

This command will calculate for you the inverse between two points. It will display the horizontal / slope distance, direction, vertical distance and slope between the two points. You do not need to have a line drawn between the points to use the inverse command.



The screenshot shows a software dialog box for the 'Inverse' calculation. The title bar displays the text "[1000 to 1001] 24.360m @ 45°12'46\"

A large font can be set for the results toolbar and COGO results. Please refer to the [Options](#) topic for more information.

All Inverse information is saved in the COGO History file called CogoCalcs.txt located in your Project folder. Please refer to the [COGO History Viewer](#) topic for more information.

Traverse Inverse

Function

1. Start the inverse command and make sure the **Traverse Inverse** and **Line** options are selected.
2. Enter or choose the first point to calculate from, and press your enter key to continue on to the next point.
3. Now you can choose or enter the second point and press your Enter button to compute an answer.
4. The inverse information will be displayed in the results toolbar.
5. In the COGO history you will see the following information for the two points:

```
-----  
INVERSE  
-----  
PNT 44 to 8 (HD 1352.84' @ NA 323°48'03.1") SD 1353.39' GR -2.85' VD -  
38.51' AR 323°48'03.1"
```

Your first inverse will calculate a right angle from north to the direction you inverted.

Multiple Lines

After you have specified two points, you can continue inverting from point to point. You should notice that the point id previously in the 2nd point field will move to the 1st point field, and the cursor will remain in the 2nd point field allowing you to quickly enter in your next point.

If you continue inverting from point to point, the angle right will not be referenced to north, but the last leg you inverted. Essentially this is computing a clockwise angle between the current and last legs you invert.

Perimeter Distance and Area

If you close back to the first point, a perimeter distance and enclosed area will also be computed.

Radial Inverse

You can compute radial inverses from a point.

Function

1. Start the inverse command and make sure the **Radial Inverse** and **Line** options are selected.
2. Enter or choose the 1st point to calculate from, and press your enter key to continue on to the next point.
3. Now you can choose or enter the 2nd point and press your Enter button to compute an answer.
4. The inverse information will be displayed in the results toolbar.
5. You can now continue computing radial inverses. The 2nd point field will remain activated allowing you to continue entering point numbers.

Radial Arc

You can compute the curve information for an arc defined by three points, PC (start), Radius Point, and PT (End)

Function

1. Start the inverse command and make sure the **Rad Arc** button is turned on.
2. Enter or choose the starting point for the arc in the Start field, and press your enter key to continue on to the next point.
3. Enter or choose the radius point in the Arc field, and press your enter key to continue on to the next point.
4. Enter or choose the end point for the arc in the End field, and press your enter key to compute an answer.
5. The inverse information will be displayed in the results toolbar.

Three Point Arc

You can compute the curve information for an arc defined by three points along the arc.

Function

1. Start the inverse command and make sure the **3 Pt Arc** button is turned on.
2. Enter or choose the starting point for the arc in the Start field, and press your enter key to continue on to the next point.
3. Enter or choose the point that falls on the arc in the Arc field, and press your enter key to continue on to the next point.
4. Enter or choose the end point for the arc in the End field, and press your enter key to compute an answer.
5. The inverse information will be displayed in the results toolbar.

Traverse / Intersection

[Main Menu](#) | [Calculations](#) | [Traverse / Intersection](#)

FieldGenius includes a powerful COGO function that allows you to compute new points. The toolbar allows you to specify the solution type, point numbers, directions and distances. When you enter enough information to compute a solution it will be draw visually on the screen. Pressing the Store Pnt button will store the point that you just solved.

Input

You can type in the point ID, or select a point by tapping on the map screen.

The direction and distance fields support the [direction](#) and [distance](#) recall features.

If you are measuring distances with a Leica Disto, just double tap in the distance field and choose the "Disto Observation" option.

Disto Distances

If you have a Leica Disto, you can send distances back to the distance edit fields. Simply double tap the distance field and select "Disto Observation" which will then set FieldGenius in a "waiting" mode. Take the measurement with the Disto, press the Bluetooth icon on the Disto, and the measured distance will be accepted by FieldGenius.

Calculator

You can open our calculator by double-tapping the Direction or Distance fields then pressing Calculator on the Keypad screen.

Information

You can review the results of your calculation by pressing the "i" information button. For intersections with multiple solutions, the results of both solutions will be displayed.

Solution Methods

Method: Traverse

The traverse method allows you to define a direction and distance that you want to traverse. After you solve your point and store it, it will become the new start point.

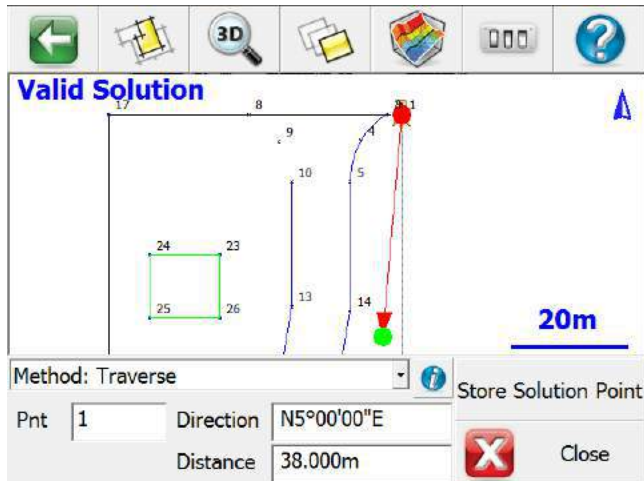

Method: Direction - Distance

This will compute two solutions based on the values you input. To store the solution, simply press the **Store Pnt** button which will ask you what solution to use, in this case either **A** or **B**.

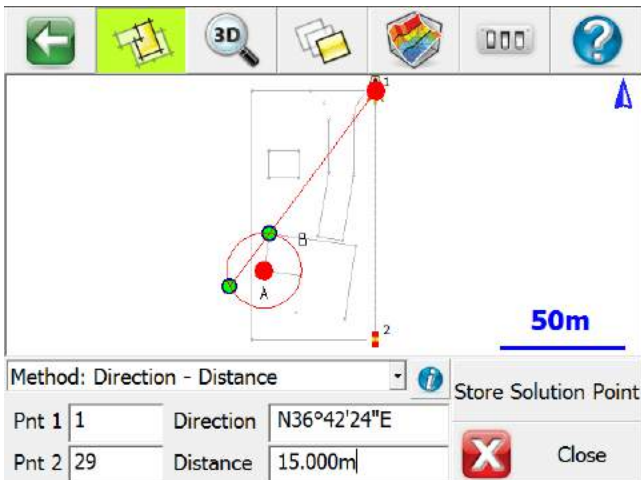

Method: Direction - Direction

Use this to compute a new point by computing an intersection using directions. After you enter your known values a solution will be displayed on the screen. To store the solution, simply press the **Store Pnt** button.

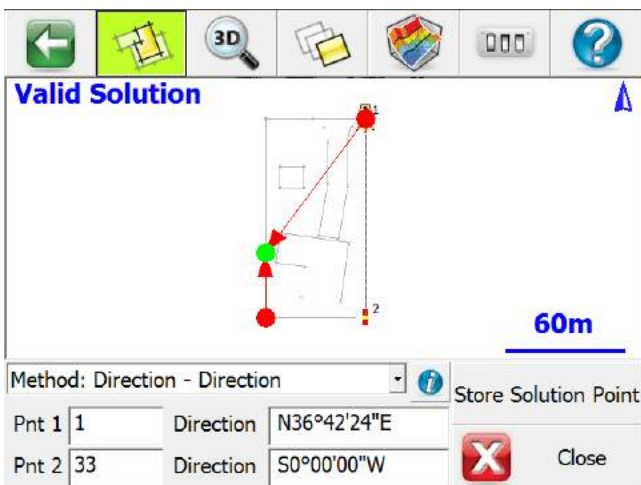

Method: Distance - Distance

Use this to compute a new point by computing an intersection using distances. This will compute two solutions based on the values you input. To store the solution, simply press the **Store Pnt** button which will ask you what solution to use, in this case either A or B.

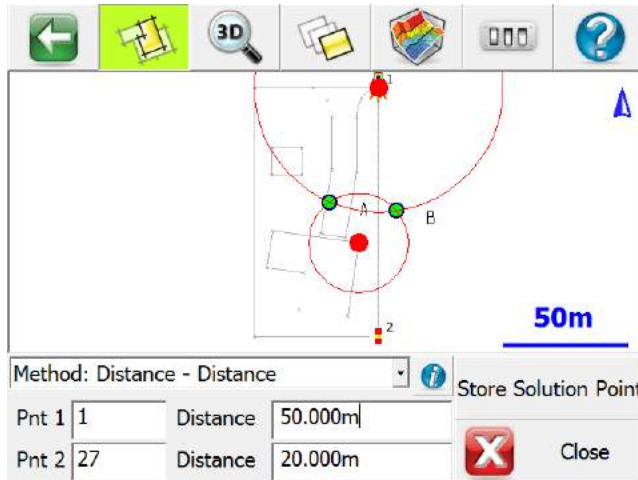

Method: Interior Angle Traverse

Use this to compute a new point by turning an angle from another point. Enter the current (setup) and previous (backsight) points, then the interior angle and the distance. Positive angles will be interpreted as angle right; if you want to turn an angle left, enter the angle as negative. To store the solution, simply press the **Store Pnt** button. After the point is stored, the points will automatically leapfrog so you can continue traversing by just entering the next interior angle and distance.

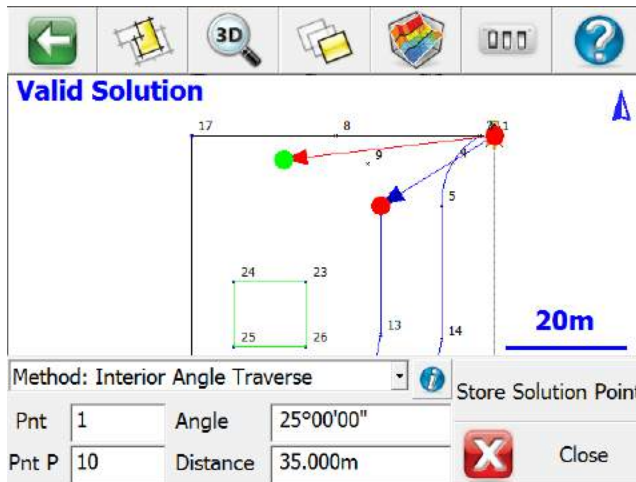

COGO Results

Every calculation you make is written to the file called CogoCalcs.txt located in your Project folder. Please see the [COGO History Viewer](#) topic for more information.

Offset Intersection

[Main Menu](#) | [Calculations](#) | [Offset Intersection](#)

Use this function to compute a point at specified offsets from an implied bearing-bearing intersection calculated from two existing points as shown.

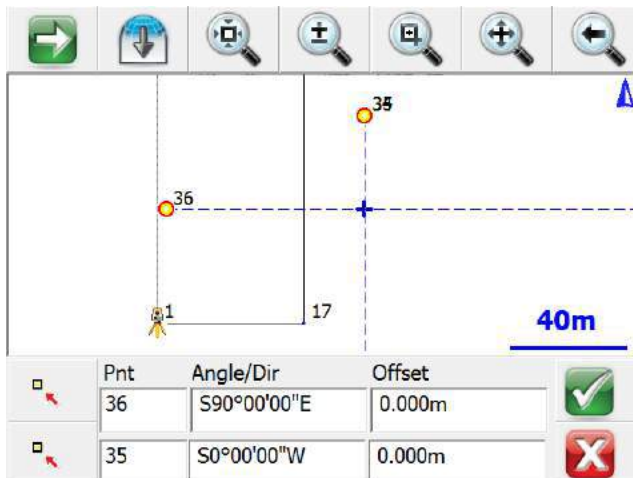

When you start the command you will see the offset intersection toolbar appear towards the bottom of the main interface. Use the point chooser to select the points that you want to use to define your directions. Offsets are computed positive to the right and negative to the left looking in the direction of the bearing you entered. You can use [angle](#) and [distance](#) recall features to help you compute your answer.

Function

1. Use the point chooser to select a point or manually type one in that defines the beginning of the bearing.
2. Enter a direction in the Angle/Dir field.
3. Enter an offset if needed. You are not required to enter an offset so the field can be left blank.
4. Repeat for the second point the first three steps.
5. Press the green checkmark to save your point. It will save the point using the [Store / Edit Points](#) function.

Station/Offset

[Main Menu](#) | [Calculations](#) | [Station/Offset](#)

This routine allows you to calculate and draw points and/or figures, offset from other existing points, figures, or DXF entities in your project. You can calculate points on a line or down and out from a line, or offset complete figures.

Selection Mode

Press the "Select Line" button to go into **Selection Mode**. You will also automatically go into Selection Mode if a line is not yet selected when you start this command.

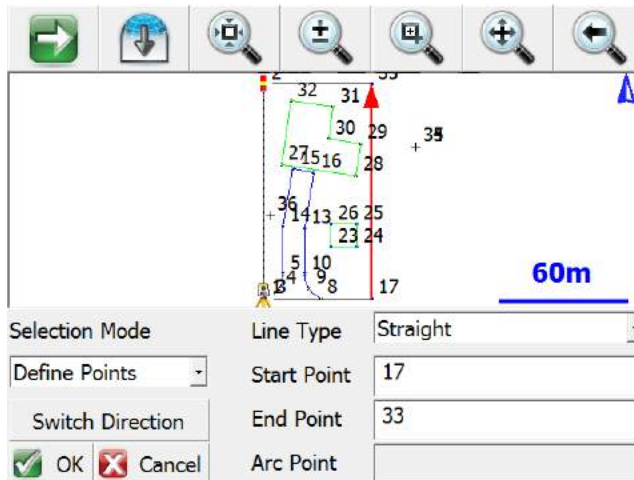

Whichever Selection Mode you use, the selected line will be highlighted in red in the map screen along with a direction indicator. If necessary, you can press the **Switch Direction** button to reverse the start and end of the selected line. Press OK to accept the selected line and proceed to the next step.

Selection Mode: Figure/DXF

Pick this mode to select an existing figure or DXF entity by selecting the desired figure from the map screen. You can select any of the following:

- Figures containing lines and/or arcs (but not curvy splines)
- DXF lines, arcs, and/or polylines (but not splines, splined polylines, or fitted polylines)

Selection Mode: Figure Segment

Pick this mode to select an individual line or arc segment from a complex figure, by selecting the desired segment from the map screen. You can select any of the following:

- a line or arc segment from a Figure (but not a curvy segment)
- (line or arc segments from a DXF polyline cannot be selected)

Selection Mode: Define Points

Pick this mode to select points in your project to define a line or arc. You can define the following line types:

- Straight Line: select a Start Point and End Point
- Arc (CW): select a Start of Curve Point, Radial Point, and End of Curve Point
- Arc (CCW): select a Start of Curve Point, Radial Point, and End of Curve Point
- Arc (3Pnt): select a Start of Curve Point, Point on Curve, and End of Curve Point.

Offset Point Mode

Use this mode to calculate a point measured Down and Out from the selected line.

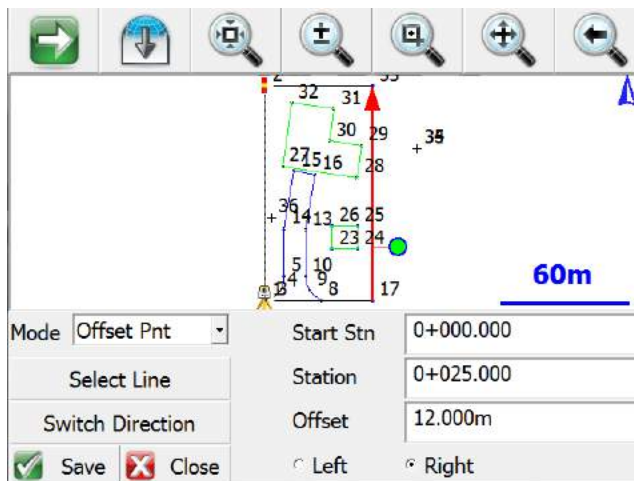

After selecting a line using any of the above Selection Modes, pick this mode and enter the Station/Offset distances and the offset direction (left or right, looking down the line).

The calculated point will be previewed in green in the map screen. Press the **Save** button to store this point.

Station Point Mode

Use this mode to calculate the Down and Out distances to a selected point, and to calculate a perpendicular intersection point on the selected line.

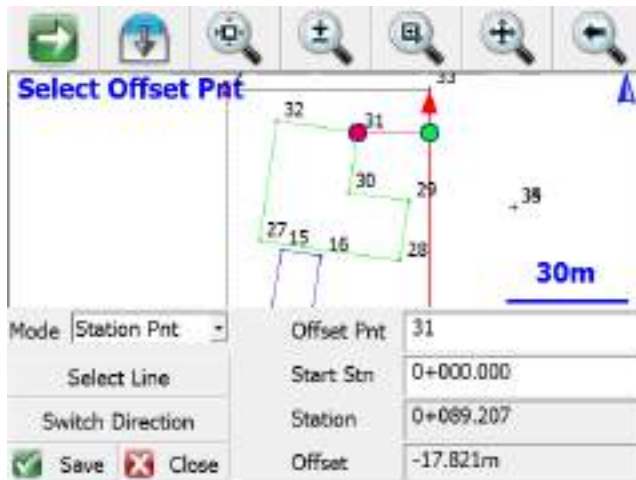

After selecting a line using any of the above Selection Modes, pick this mode and select the Offset Point by either typing in its Point ID or by selecting it from the map screen when the Offset Pnt field has focus.

The selected point will be highlighted in red in the map screen, and its Station/Offset distances from the selected line will be displayed.

A perpendicular intersection point on the line will be calculated and previewed in green in the map screen. Press the **Save** button to store this point.

Line Mode

Use this mode to draw a new line or figure, offset from the selected line.

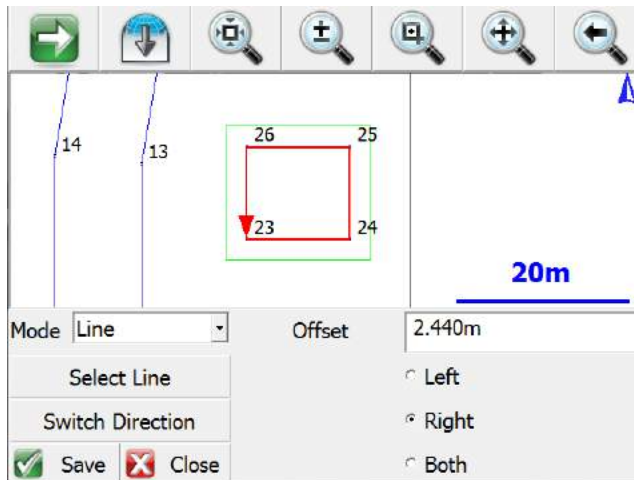

After selecting a line using any of the above Selection Modes, pick this mode and enter the distance and direction (left or right looking down the line, or both sides).

The offset line will be calculated and previewed in green in the map screen. Press the **Save** button to store this line. When a line is saved, points will be automatically stored at the start and end points, arc radial points if applicable, and polyline vertex points if applicable.

Rotate/Translate/Scale Points

Apply User Defined Parameters

[Main Menu](#) | [Calculations](#) | [Rotate/Translate/Scale](#) | [Apply User Defined Parameters](#)

Use this to rotate, translate and scale a point or group of points by entering the parameters. When this command is used notes will automatically be written to the raw file indicating what parameters were entered by the user. Coordinates that are updated with the RTS command will be recorded in the raw file with AP (Adjusted Points) records.

The RTS command has the three options located on separate screens. The user can specify more than one option at the same time, for example you could rotate a group of points by 45° CW, then translate them 25' east. This can be done in one operation, instead of two separate ones.

All of the fields have [extended edit](#) functionality. On the direction or distance fields, if you double tap them you will see a popup menu. From there you can start the calculator or use the inverse command.

When using the inverse option, simply type the two numbers for the inverse, then press the ESC key to automatically copy the value that was computed during the inverse.

The RTS function can also be accessed from the [coordinate database](#). Accessing it from there allows you to select your points from the list which in some cases might be easier than entering a point range.

Rotate: Simple Angle

This is the simplest form of rotating your points. Specify the base point for the rotation, and a rotation angle.

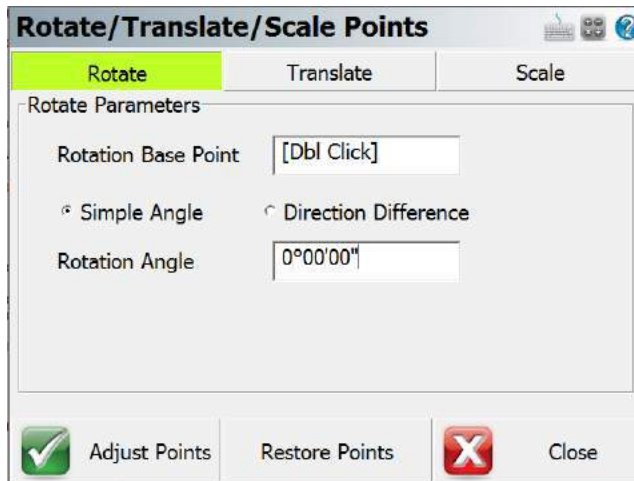

Rotation Base Point

Use this to specify the pivot point for the rotation. You can select the point by double tapping in the edit field. Use the point chooser to select the point from the map, or simply enter the point number.

Rotation Angle

Specify the desired rotation in degrees, minutes seconds (or whatever your project units are set to). You can also use the direction recall feature and enter #.# to inverse between two point numbers.

Rotate: Azimuth Difference

This allows you to define two azimuths, usually used to compute the angle needed to rotate a group of points to match a field azimuth to one from a plan.

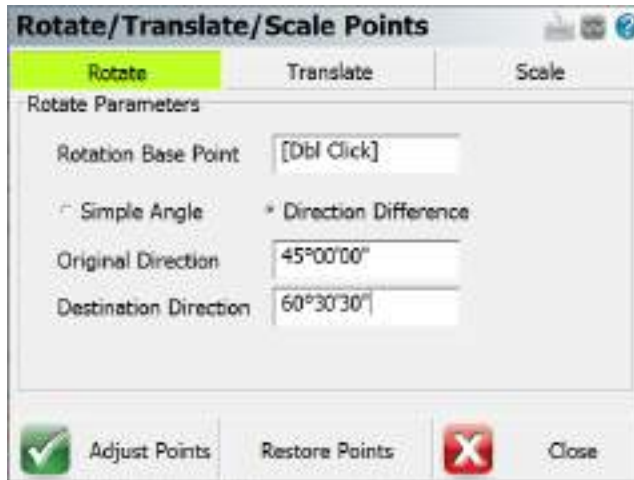

Rotation Base Point

Use this to specify the pivot point for the rotation. You can select the point by double tapping in the edit field. Use the point chooser to select the point from the map, or simply enter the point number.

Original & Destination Direction

Specify the desired rotation in degrees, minutes seconds. Depending on your project units, you will be entering either a bearing or an azimuth. You cannot use the direction recall feature such as #.#. Instead use the inverse command that appears when you double tap the field.

Translate

Use this option to specify a shift to a point or group of points. The translation is separated into three groups, shift from point to point, shift by coordinate change and shift by direction and distance. In most circumstances you will only need to use one of the three types, but you can use them in conjunction with one another if you need to.

For example, you could specify that the points are to be shifted by coordinate difference between points 10 and 20, then shifted again to the east by 50 feet.

Rotate/Translate/Scale Points

Rotate **Translate** Scale

Translate Parameters

Original Point [Dbl Click] Destination Point [Dbl Click]

Northing 0.000m

Easting 0.000m

Elevation 0.000m

Add Direction 0°00'00" Distance 0.000m

Adjust Points Restore Points Close

Original & Destination Points

These work in conjunction with one another. The difference in coordinates to get from one point to the other is calculated and added to all points. You can use the point chooser to select your points or simply type the points in the fields. The horizontal differences in the northing and easting is computed and applied to the points being transformed. The elevation of the points will remain unchanged.

Add Northing, Easting, Elevation

Any one or combination of these shifts can be applied. Simply input the value for each shift in the appropriate fields. Both negative and positive values are valid.

Add Direction and Distance

Define the shift by direction and distance. The coordinate shift in Northing and Easting will be calculated using the direction and distance you enter in the fields. If desired you may apply two shift components at the same time. For example, shift your selection of points by Direction and Distance, but also add 100.00 to the elevation. You can use [angle](#) and [distance](#) recall features to help you compute your answer.

Scale

You can scale a group of points using the scale option.

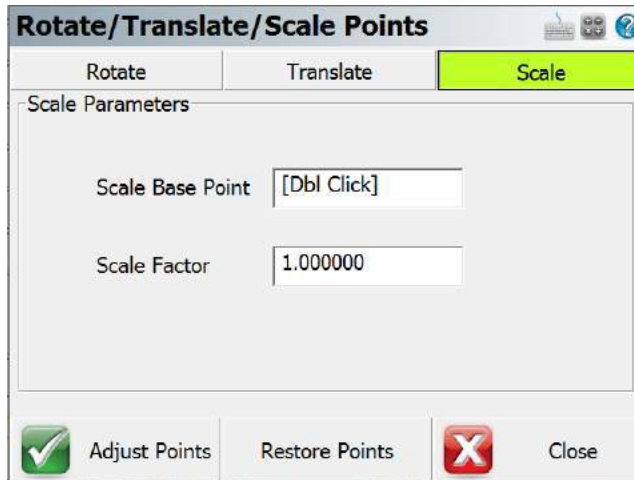

Scale Base Point

This will be the base point for the scaling and all points selected will be scaled from this point. You can enter the point number in the field or use the point chooser to select the scale point.

Scale Factor

Use this to specify the scale to apply to your selection.

Adjust Points

Once you've specified your options and parameters, press the Adjust Points button to apply to your coordinates. Once you press it, you will see a screen that will allow you to specify which points you want to apply the calculation to.

Restore Points

After you adjust a group of points with the RTS command, you have the option of undoing your changes and restore the points back to their previous coordinate values. You can only undo the last operation that was done. Also if you close FieldGenius, the restore coordinate values are not saved.

Reset All Parameters

After the RTS command is used, if you start the command you will see a message "Reset All Parameters?" If you choose yes, then FieldGenius will restore all the RTS fields back to their default settings. If you choose no, then your previously inputted data is retained.

Apply Control Calculated Parameters

[Main Menu](#) | [Calculations](#) | [Rotate/Translate/Scale](#) | [Apply Control Calculated Parameters](#)

Use this to rotate, translate and scale a point or group of points by matching up control points. When this command is used notes will automatically be written to the raw file indicating what parameters were entered by the user. Coordinates that are updated with the RTS command will be recorded in the raw file with AP (Adjusted Points) records.

Adding Control

Pick “Add Control” to add a control pair.

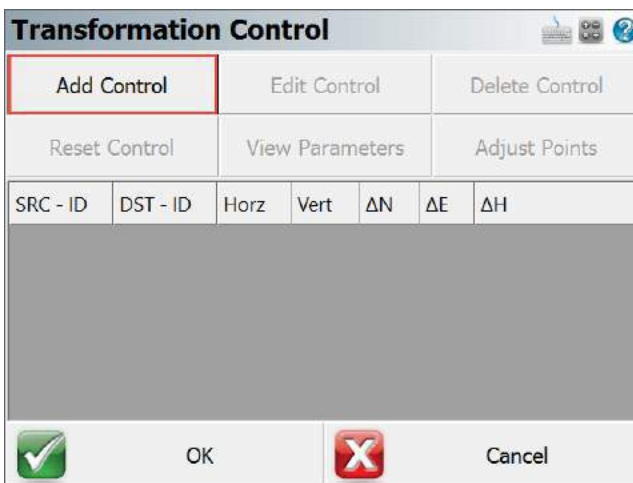



Confirm the Control type (2D or 3D, or none) by selecting the “Apply Horizontal” and “Apply Vertical” checkbox options. Pick the “Select” option for Source Control Point selection and Destination Control Point selection. The standard Point Picker tool is opened to enter or select the point.

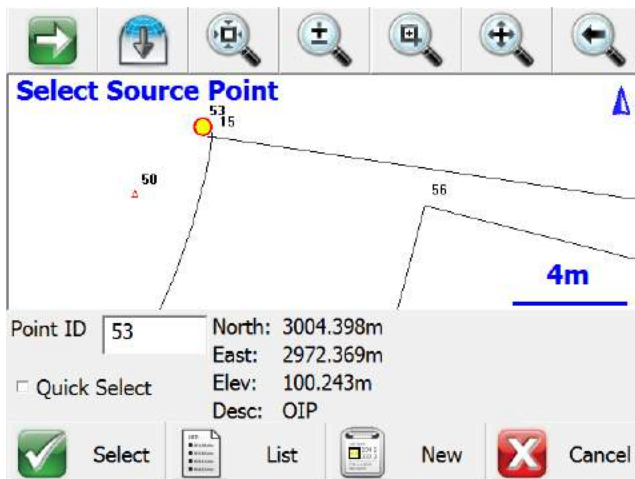

Editing Control

Select a control pair, then pick “Edit Control” to edit the control pair. The resulting dialog allows the user to modify any of the parameters of the control pair.

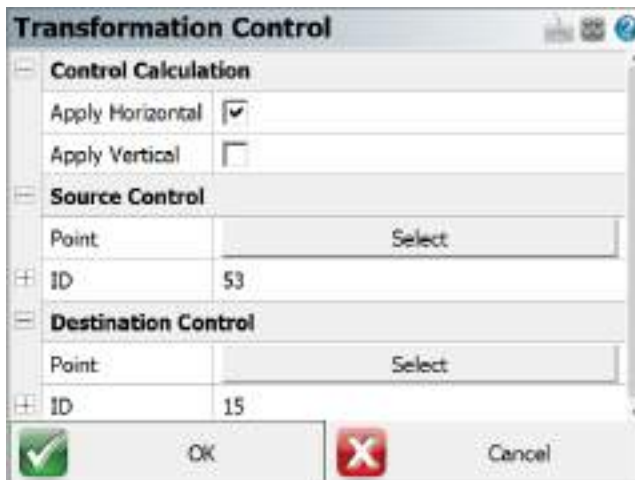

Deleting Control

Select a control pair, then pick "Delete Control" to delete the control pair. A confirmation screen is presented.

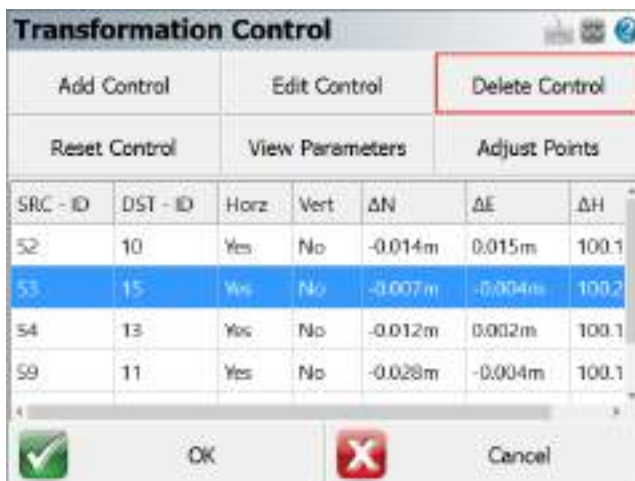

Resetting Control

Pick "Reset Control" to remove all control pairs. A confirmation screen is presented.

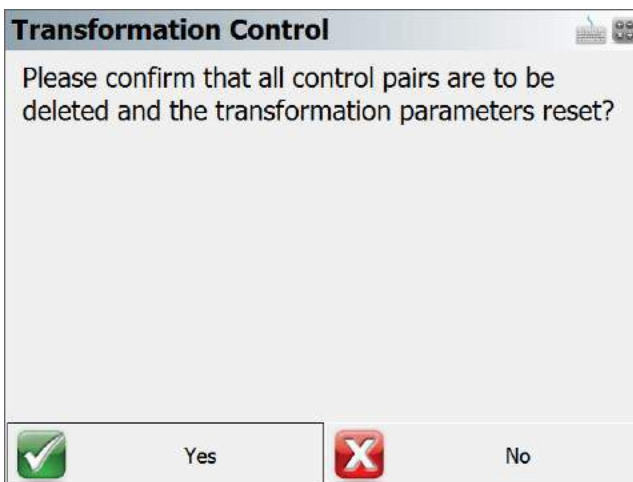
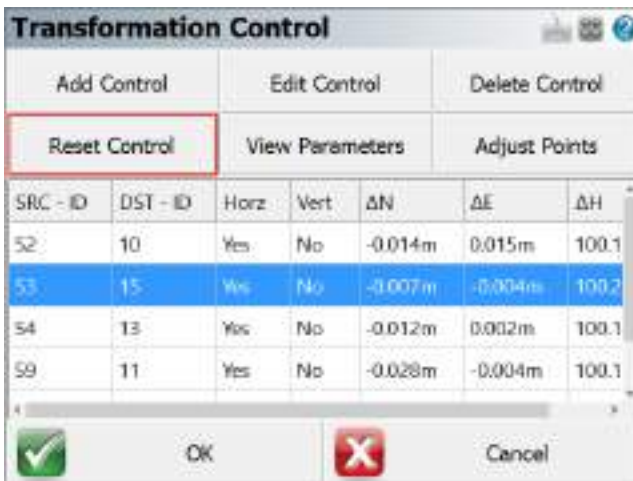

Viewing Transformation Parameters

Pick "View Parameters" to view the calculated parameters of the transformation, and to toggle the application of the calculated scale factor. By default the scale will not be calculated.

Transformation Control

Add Control Edit Control Delete Control

Reset Control **View Parameters** Adjust Points

SRC - ID	DST - ID	Horz	Vert	ΔN	ΔE	ΔH
52	10	Yes	No	-0.014m	0.016m	100.1
53	15	Yes	No	-0.007m	-0.004m	100.2
54	13	Yes	No	-0.012m	0.002m	100.1
59	11	Yes	No	-0.028m	-0.004m	100.1

OK Cancel

Transformation Parameters

Similarity Parameters

Calculate Scale

Translate North 472.121m

Translate East -411.199m

Translate Height 0.000m

Rotation 8°30'08.86068"

Scale 1.0000000000

OK

Adjusting Points

Pick "Adjust Points" to apply the calculated parameters to points in the project. The Point Selection dialog allows the user to pick the option to transform points measured with total station. This option will scan the raw file to extract all Point IDs that were observed with a total station. In addition (or instead), the user can enter the point(s) to be transformed.

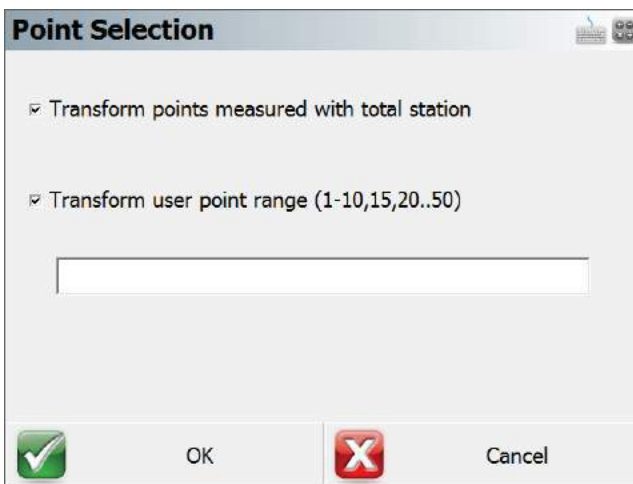

Additional Notes

1. From the main “Transformation Control” screen, the **OK** menu option will save the current state of the entered parameters and then exit to the Map Screen. The **Cancel** menu option will not save any changes made since the current instance of the routine was started.
2. The program saves the values of the point coordinates at the time they were added as control. After points have been adjusted, the parameters that are stored will not be updated with the new coordinates, and as such they can become “stale”. This is to allow transforming additional points with the original parameters. When point coordinates have changed, the program will alert the user of the modified coordinates. If additional control will be added to re-calculate a transformation, it is best to use the “Reset Control” option and re-add all the control pairs.

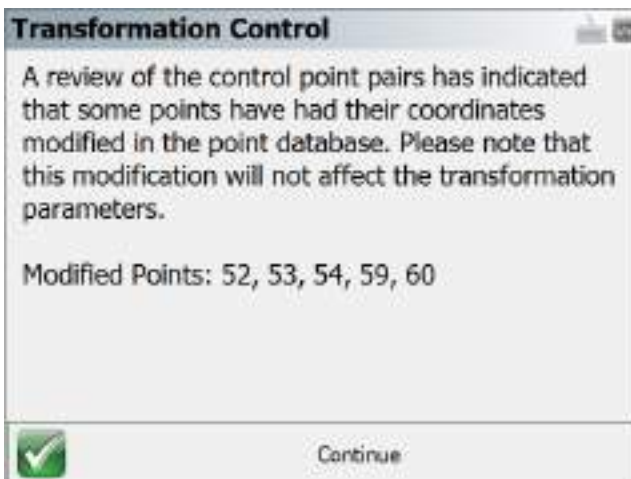

Curve Calculator

[Main Menu](#) | [Calculations](#) | [Curve Calculator](#)

FieldGenius includes a curve calculator that can be used to check curve data and also compute and curve points.

Radius - Arc Length	
Arc Direction	Right
Arc Length	0.000m
Arc Radius	0.000m
Arc Chord Length	0.000m
Arc Chord Bear	0°00'00"
Arc Delta Angle	0°00'00"
Deg of Curve (arc)	0°00'00"
Deg of Curve (chord)	0°00'00"
Tangent Length	0.000m

Store PT Pnt Store Center Pnt  Close

Define Known Data

You first have to define what known information you want to use to compute the curve. If you click on the drop down list you will see a list of all the options that can be used to compute the unknown values.

Enter the Known Data

Once you define the known data format, you will see grayed out fields which indicate they can't be edited. White areas indicate fields that can be edited, and these fields will match what you defined in the first step.

1. You always have to define the direction for the curve, either right or left.
2. Enter your know values.
3. If you want to store points, you need to define the PC point. You can enter the point id or use the point chooser.
4. You also need to define the PC Tangent direction, so FieldGenius knows the orientation of the curve.

Store Points

Once you have computed your curve data, you have the option of storing the PT and Center points. When you press either button you will see the store and edit screen.

Area Calculator

Main Menu | Calculations | Area Calculator

The area calculator is used to compute areas as well as predetermined areas.

When defining the boundary area, you can select points, lines and arcs from the map, or type the point numbers in manually. Lines and points from DXF files are also valid and can be selected using the Define Area toolbar.

Defining an Area

Define Area Toolbar (Points)



Select Point

The define area toolbar is used to help you define an area. If the first button is set to **Select Point**, the toolbar is in "point selection" mode and will only accept points picked from the map or point numbers that are typed in. This button acts as a toggle and will toggle between Select Point and Select Line.

Line

If you are defining a straight segment, then you should leave the **Line** button turned on. Simply select two points from the map, or enter the point numbers manually.

Rad Arc

Use this to define a curved segment where you know the start, radius, and end points. You need to first pick the start of the arc, then press the **Rad Arc** button to define the radius point. After doing so, the program will automatically switch back to the Line segment type which at that time you should select the end of the arc.

3 Pnt Arc

Use this to define a curved segment where you know three points on the arc. You need to first pick the start of the arc, then press the **3 Pnt Arc** button which will allow you to define two more points on the arc for a total of three points. The program will automatically switch back to the Line segment type after the third point is selected.

Remove Previous

Use this to remove segments that were defined for the area boundary. This will remove the segments one at a time starting with the last segment that was defined.

Define Area Toolbar (Line)



Select Line

The define area toolbar is used to help you define an area. If the first button is set to **Select Line**, the toolbar is in "line selection" mode and will only accept lines picked from the map. This button acts as a toggle and will toggle between Select Point and Select Line.

Switch Direction

Since this routine accepts FieldGenius figures as well as DXF entities, at times you need to switch the direction of a DXF line so that it matches the direction that you are traversing around to define the area boundary. As you select lines from the map you will see a red marker appear at the end of the line.

Remove Previous

Use this to remove segments that were defined for the area boundary. This will remove the segments one at a time starting with the last segment that was defined.

Enclosed Area Calculation

To compute an area you need to make sure you have the **Calculate Area** tab selected. You can then press the **Define Area** button to define the boundary that will outline the area perimeter. It is important to note that you are not required to "close" the area by selecting the original starting point.

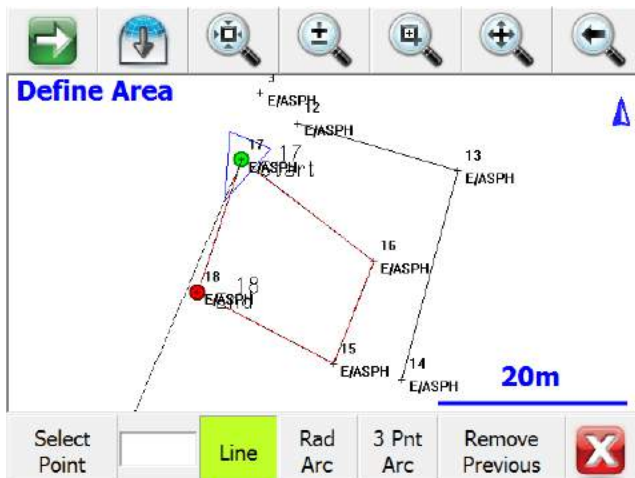

The green marker indicates the start of the area perimeter, whereas the red marker indicates the last point on the perimeter. When ready to compute the area, simply press the exit button (red X) on the Define Area toolbar.

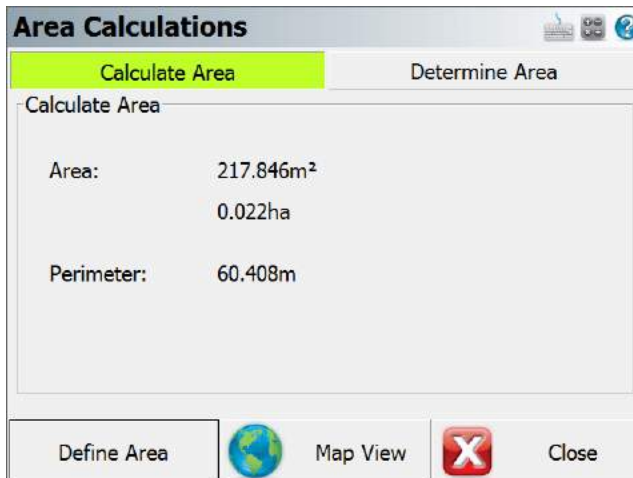

Determine Area (Predetermined)

FieldGenius can compute predetermined areas using the **Hinge** or **Parallel** Methods.

The Hinge Method allows you to specify a fixed point that the new boundary should hinge from.

The Parallel Method helps you compute the location of a new boundary using a user entered direction, usually parallel to one of the fixed sides.

Hinge Method

The first thing you need to do when using the hinge method is define the fixed sides of your boundary. Once you do this, on the determine area screen you can enter the predetermined area amount you want to compute a solution for, plus define what point is fixed and is to be used as the hinge point.

The start and finish points (markers) are represented using a green and red circle marker. You can always press world button on the [Display toolbar](#) which will place text labels next to the start and finish points.

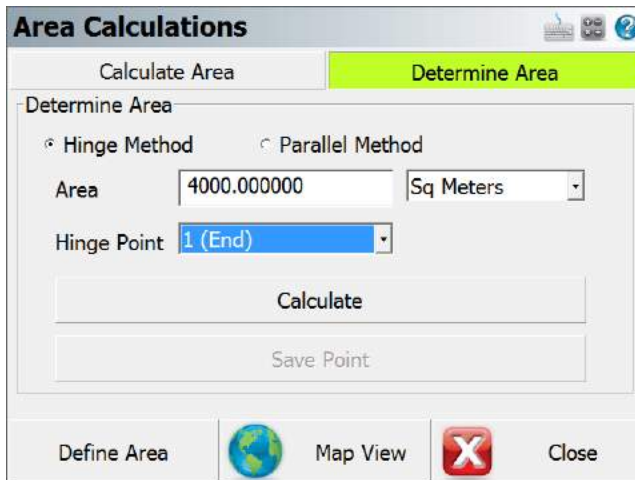
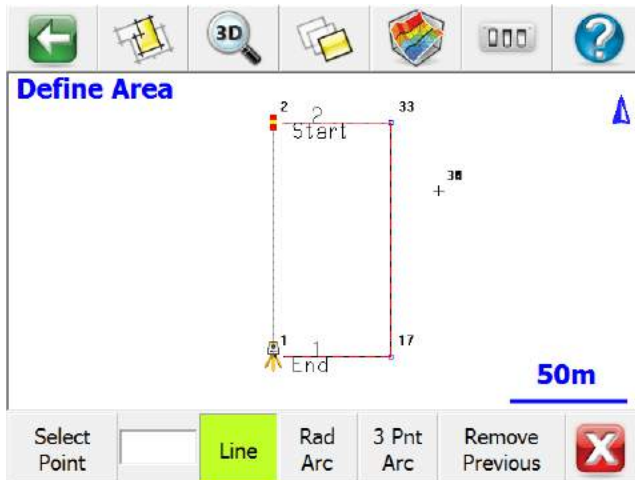

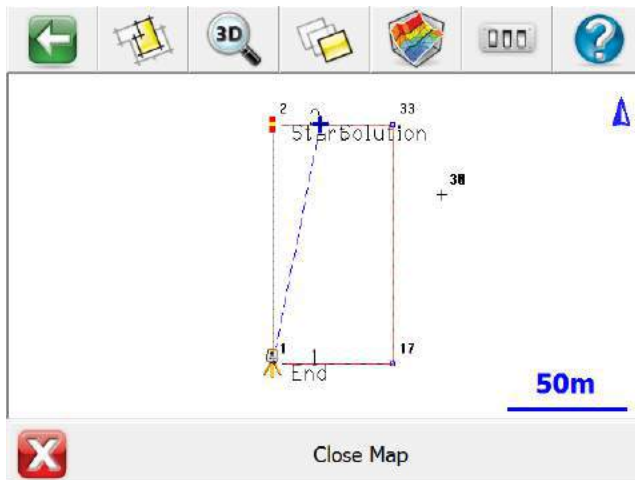

FieldGenius will compute the new boundary so that it intersects the boundary segments connected to the start and finish points that were defined.

In the example below, the original left side of the lot now has two segments that define it. In this example, the solution would have to intersect the boundary segments from (108 - 9001). If we use the same predetermined area parameters as above, FieldGenius will not be able to compute a solution because the solution does not intersect the segment between (108 - 9001). It actually would intersect the line from (9001 - 109).

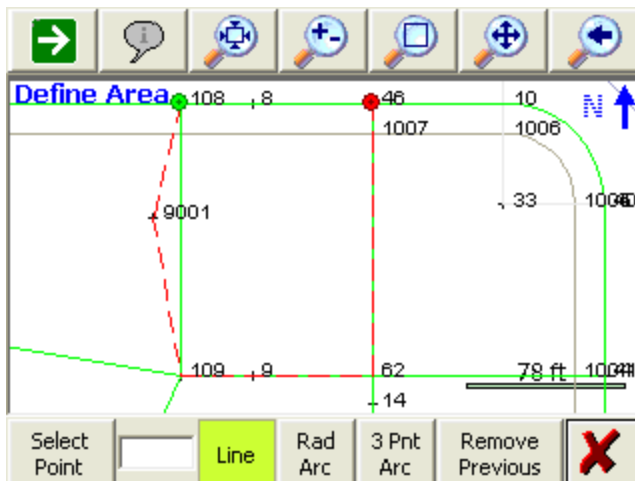

However if we increase the predetermined area amount from 10000 to 12000, a solution can be computed because the solution can now intersect the segment between point 108 and 9001. If you did want to use an amount of 10000, all you would need to do is change the start point from 108 to 9001.

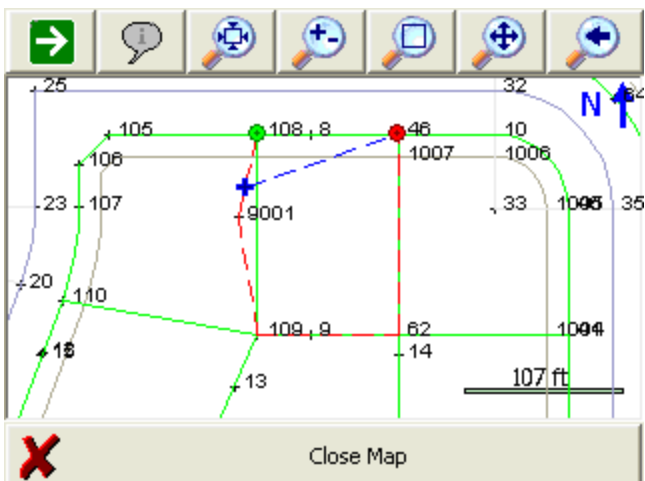

Parallel Method

The first thing you need to do is define the fixed sides for your area. It is important to note that FieldGenius will try to compute the new boundary so that it intersects the segments connected to the start and finish points that you define.

The start and finish points (markers) are represented using a green and red circle marker. You can always press world button on the [Display toolbar](#) which will place text labels next to the start and finish points.

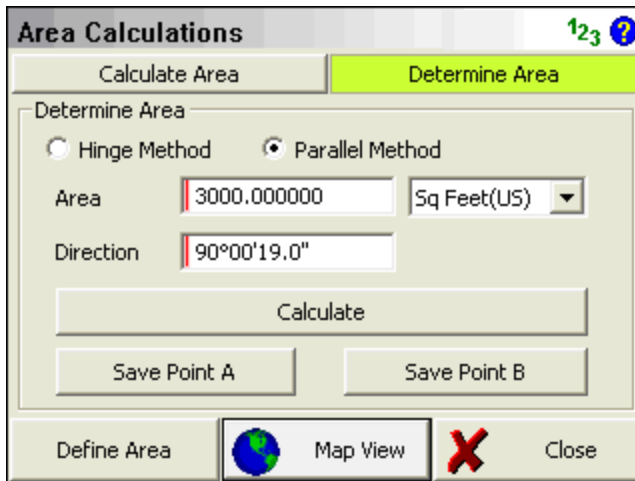
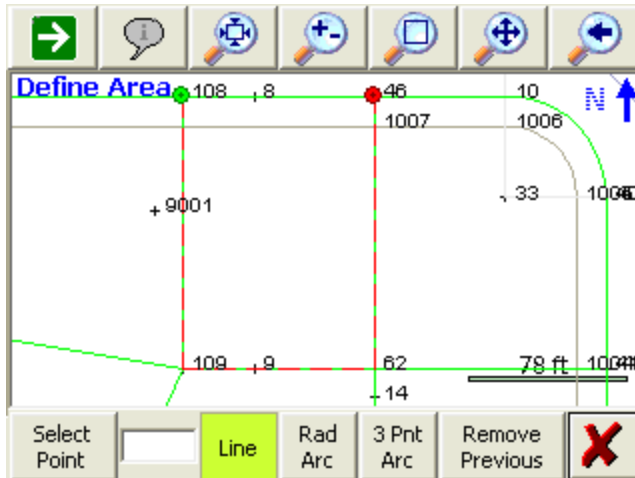

Once a solution has been found you can always preview it by pressing the **Map View** button.

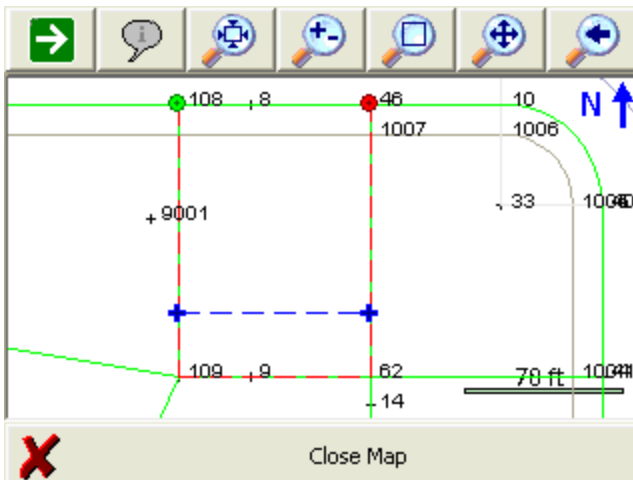

As mentioned above, **FieldGenius** will compute the new boundary so that it intersects the boundary lines connected to the start and finish points that were defined.

In the example below, the original left side of the lot now has two segments that define it. In this example, the solution would have to intersect the boundary segments from (108 - 9001) and from (46 - 62). If we use the same predetermine area parameters as above, FieldGenius will not be able to compute a solution because the solution does not intersect the two segments.

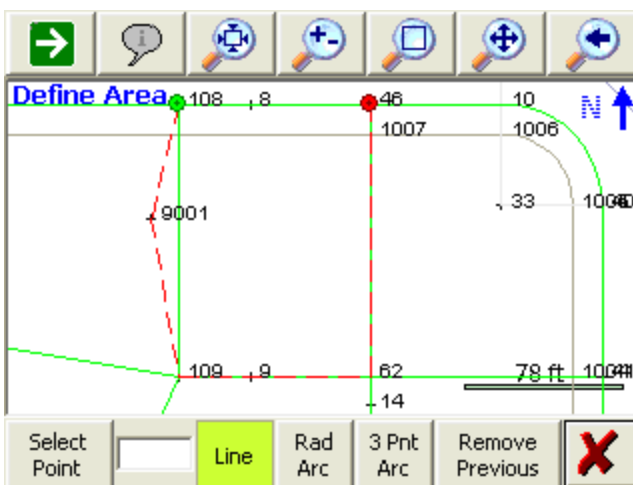

However if the direction for the boundary is changed to 130° , and the area amount changed to 7000, a solution can be computed because the solution intersects the two segments connected to the start and finish points.

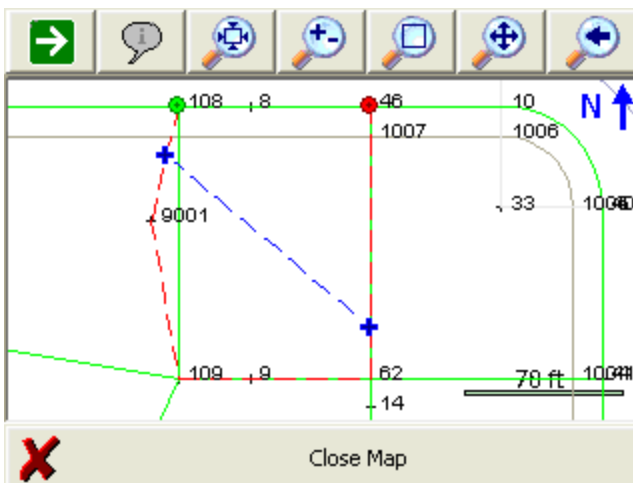

If you did want to keep the same area amount and direction, all you would need to do is change the starting point.

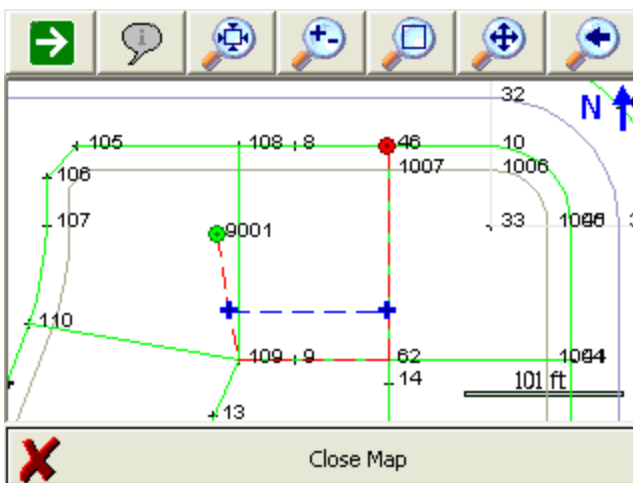

Storing a Solution

When you have a solution that you want to store simply press the **Save Point** button or buttons depending on the solution method you used. If you used the parallel method you will have two solutions to choose from. You can switch to the **Map** view and turn the **World** button off if you want to see some temporary text labels next to the computed solution points.

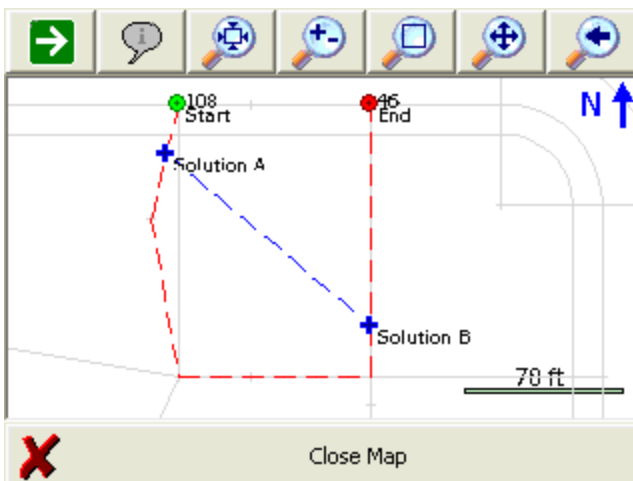

Triangle Calculator

[Main Menu](#) | [Calculations](#) | [Triangle Calculator](#)

The triangle calculator can be used to solve unknown sides or angle of a triangle given three know components.

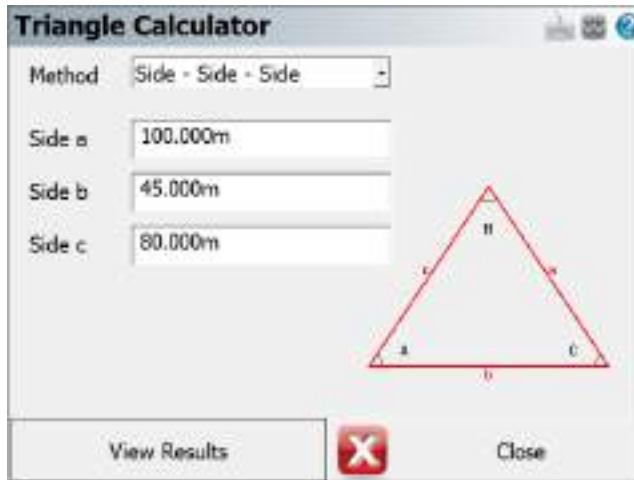

You first need to select a Method for the triangle calculation. There are 5 methods available to choose from and you can decide what method to use based on your known triangle components.

- **Side-Side-Side:** Use this when you know the length of the three sides of a triangle.
- **Angle-Side-Angle:** Use this when you know two angles and the distance between them.
- **Side-Angle-Angle:** Use this when you know two angles and one side. The know side must not lie in between the two known angles.
- **Side-Angle-Side:** Use this when two sides and the angle between them are known.
- **Side-Side-Angle:** Use this when two sides and one angle that is not between the known sides are known. This method will produce two solutions.

After you choose the solution method and enter the known components of the triangle, press the **View Results** button to complete the calculation.

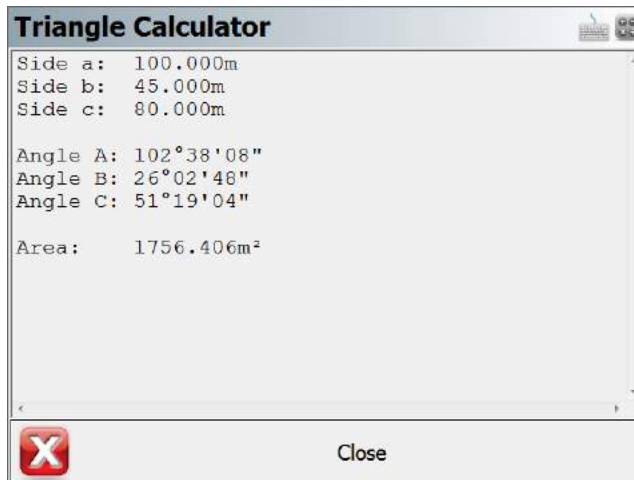

Coordinate Calculator

[Main Menu](#) | [Calculations](#) | [Coordinate Calculator](#)

The coordinate calculator is used to convert Geodetic coordinates to Cartesian coordinates and vice versa. You can also use it to convert ellipsoid heights to orthometric heights if you have defined a geoid.

Define Coordinate Systems

Press the Select Coordinate Systems button to select the coordinate system and geoid you want to use.

In the following example the user chose to convert between UTM NAD83 Zone 11 to Lat and Long WGS 84. Also at the same time the elevation is being converted from an ellipsoid height to an orthometric height using the Canadian HT2.0 geoid.

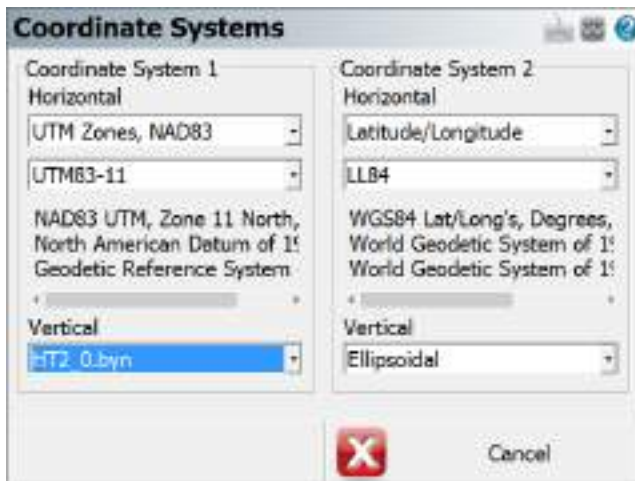

Convert Coordinate

Once you've defined the coordinate systems you want to convert between you can then enter some numbers.

Press the Convert button to make the computation.

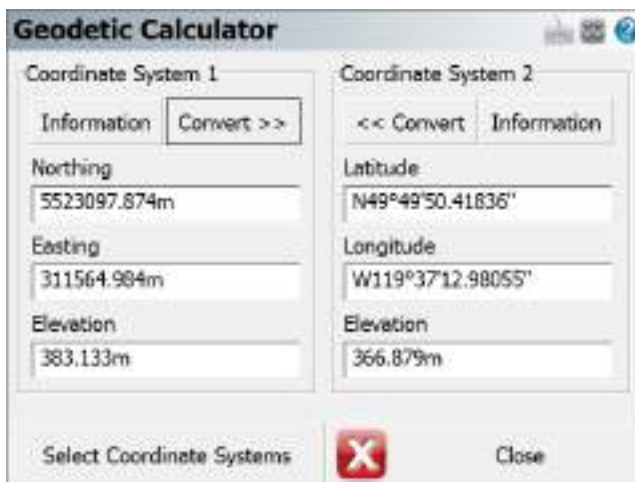

Information

Press the information button to see details about the coordinate system such as grid scale, and convergence angle.

Scientific Calculator

[Main Menu](#) | [Calculations](#) | [Scientific Calculator](#)

FieldGenius includes an RPN (Reverse Polish Notation) Calculator. RPN Calculators (such as the HP48) are stack based, where values are popped from a stack, and the results of the calculation are pushed back onto the stack. This type of calculator may seem foreign at first, so several examples of its use are included below.

The calculator can be launched several ways:

1. By tapping inside certain numeric entry fields to directly open the Calculator. This will copy whatever value is currently in that entry field into the calculator's command line, and the calculated value can then be automatically copied back into the field which the calculator was launched from.
2. By tapping inside most text and numeric entry fields to open the keypad, and then tapping the "Calculator" button on the keypad. This will copy whatever value was currently in that entry field first into the keypad and then into the calculator's command line. The calculated value can then be automatically copied back into the keypad and then to the field which the calculator was launched from.
3. It can be launched from the map screen using its Keyboard Shortcut (default is the F key).
4. Or it can be launched through the menu system.



The Stack

The stack is a series of memory storage locations for numeric data. Each location in the stack is called a Level. There are a maximum of 20 Levels available in the Stack.

As you push new values on the stack, the stack grows to accommodate them: the new data moves into level 1, and older data is pushed to a higher level. Data in level 1 will move to level 2, data in level 2 to level 3, and so on. Any data in level 20 will be bumped off the stack if new data is added, and is unrecoverable. As you pop data off of the stack, the number of levels decrease as data is automatically bumped down to lower levels.

The stack display always shows levels 1 to 5, and you can use the scroll bar to view the other levels up to level 20.

The Command Line

The command line is where you enter or edit data. You can enter up to 20 characters in the command line.

The command line is closely tied to the stack. You use it to enter or edit data and then process it, and the results are pushed onto level 1 of the stack.

Function

Numeric Entry

You can enter values using the keys provided on the calculator or use the numeric keys on your keyboard.

[0] - [9] - Types numeric data into the command line

[←] - Types a backspace into the command line. You can also use the Backspace key on your keyboard.

Stack Operations

Functions are available to help you manipulate data that is currently stored in the stack.

[**EDIT**] - Pops data from level 1 of the stack into the command line, bumping all other data down one level.

[**SWAP**] - Switches positions of the data in levels 1 and 2 of the stack. Or you can highlight a level on the stack and pressing the Swap button will move the value to level 1.

[**CLEAR**] - Deletes all data from the stack.

[**DROP**] - Deletes the data in level 1 of the stack, bumping all other data down one level.

[**ENTER**] - Pushes data from the command line into level 1 of the stack, bumping all other data up one level. You can also use your keyboard's Enter key.

The Shift Button

[**SHIFT**] - This is used to show the reverse functions of each operation.



When the shift key highlighted in grey, it indicates that the shift key is currently depressed, press it again to un-shift



The OK/Cancel button

[OK] copies the value in level 1 of the stack back into the either the keypad or the numeric entry field which was double-tapped to launch the calculator, and closes the calculator.

[Cancel] closes the calculator, without copying the data anywhere

Note:

All data will remain on the Stack, and will be available the next time the calculator is re-started. On Exiting from FieldGenius, all data on the stack is written out to a file called CalcStack.bin and will be automatically re-loaded when FieldGenius is re-started.

Converting Units

[METER] , [FEET] , [FTUS]

Assigns a linear unit to the data in the Command Line, and places it on the Stack. If the Command Line is empty, then the unit is applied to the data currently in Level 1 of the Stack.

[DEG] , [RAD] , [GRAD]

Assigns an angular unit to the data in the Command Line, and places it on the Stack. If the Command Line is empty, then the unit is applied to the data currently in Level 1 of the Stack.

Note:

You do not need to press enter before pressing a unit button, it will automatically move whatever data is in the Command Line into Level 1 of the Stack.

Example: determine the metric equivalent of 15 feet:

[1][5] [FEET] [METER]

1: 4.572_m

Example: determine the gradient equivalent of 45 degrees:

[4][5] [DEG] [GRAD]

1: 50_grad

Basic Mathematical Operations

[+], [-], [×], [/]

Performs a mathematical operation on the data in Level 1 and Level 2 of the Stack, or on Level 1 and the Command Line.

Note:

You do not need to press [ENTER] before pressing a math button, it will automatically move whatever data is in the Command Line into Level 1 of the Stack.

Example: determine the sum of 2 + 3

```
[2] [ENTER] [3] [+]
1: 5
```

Advanced Mathematical Operations

Note:

You do not need to press [ENTER] before pressing a math button, it will automatically move whatever data is in the Command Line into Level 1 of the Stack.

[P>R], [R>P]

Convert data between Polar and Rectangular notation

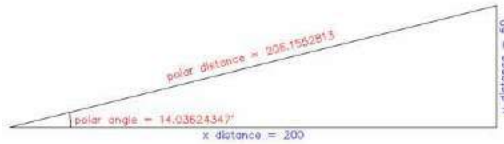

Example: Convert 206 feet at 14° to Rectangular components.

```
[2][0][6][ENTER][1][4][P->R]
2: 199.8809196
1: 49.83591049
```

Example: Convert x=200, y=50 to Polar components.

```
[2][0][0][ENTER][5][0][SHIFT][R->P]
2: 206.1552813
1: 14.03624347_°
```

[DMS>], [>DMS]

Converts data between Degrees/Minutes/Seconds and Decimal Degrees

Example: Convert from 12° 34' 56" to decimal degrees

```
[1][2][.][3][4][5][6][DMS->]
1: 12.58222222_°
```

Example: Convert from 12.3456° to degrees, minutes, seconds

```
[1][2][.][3][4][5][6][SHIFT][->DMS]
1: 12.204416
```

[DMS+], [DMS-]

Add or subtract DMS angles

Example: 12° 34' 56" + 1° 2' 3"

```
[1][2][.][3][4][5][6][ENTER][1][.][0][2][0][3][DMS+]
1: 13.3659
```

[SIN], [COS], [TAN], [ASIN], [ACOS], [ATAN]

Trigonometric calculations

Example: Cosine of 12.3456°

```
[1][2][.][3][4][5][6][COS]
1: 0.9768757205
```

Example: Cosine of 12° 34' 56"

```
[1][2][.][3][4][5][6] [DMS->] [COS]
1: 0.9759844006
```

Example: Arc Cosine of 0.3456°

```
[0][.][3][4][5][6] [SHIFT] [ACOS]
1: 69.78157371
```

- [1/X]** Inverse of X. Example: $1/4 = [4] [1/X] = 0.25$
- [√x]** Square Root of X. Example: $\text{ROOT}(9) = [9] [\sqrt{x}] = 3$
- [LOG]** Logarithm (Base 10). Example: $\text{LOG}(1000) = [1][0][0][0] [\text{LOG}] = 4$
- [+/-]** Change Sign. Example: $[3] [\text{ENTER}] [+/-] = -3$
- [x²]** X Squared. Example: $3^2 = [3] [x^2] = 9$
- [LN]** Natural Logarithm. Example: $\text{LN}(148) = [1][4][8] [\text{LN}] = 4.997212274$
- [EEX]** Scientific Notation. Example: $3 \times 10^4 = [3] [\text{EEX}] [4] = 30,000$
- [pi]** Pushes pi onto the stack. Example: $[\text{SHIFT}] [\text{pi}] = 3.141592654$
- [x√y]** X'th root of Y. Example: $3\text{ROOT}(8) = [8] [\text{ENTER}] [3] [\text{SHIFT}] [x\sqrt{y}] = 2$
- [10^x]** 10 to the X. Example: $10^3 = [3] [\text{SHIFT}] [10^x] = 1000$
- [y^x]** Y to the X. Example: $2^3 = [2] [\text{ENTER}] [3] [\text{SHIFT}] [y^x] = 8$
- [e^x]** Exponent of X. Example: $e^1 = [1] [\text{ENTER}] [\text{SHIFT}] [e^x] = 2.718281828$

Instrument Selection

Main Menu | Connect

The Instrument Selection screen allows you to choose the type of equipment you will be connecting to FieldGenius. An Instrument Profile can be created for each different instrument you will be working with, to make changing between different hardware a breeze. Once you have setup a profile for each different instrument you will be using, switching between them is a simple matter of selecting the appropriate profile and pressing **Connect**.

Note, this screen is not available if FieldGenius is running onboard your instrument.



For all future Projects you create with FieldGenius, when you create a new or open an existing Project you will see the Instrument Selection screen with the profiles you have already created. It will default to the last Profile you used, so if you are using the same instrument just press **Connect**. If you are using different equipment, just select the appropriate Instrument Type and Profile (or add a new profile if one does not yet exist for it), then press **Connect**.

Your profiles are stored in the **Settings.xml** file within the ...**MicroSurvey\FieldGenius\FG Projects** (Windows CE/Mobile) or ...**Documents\MicroSurvey\FieldGenius\FG Projects** (Windows Tablet/PC) directory so once you have configured one data collector, you can copy this file onto other data collectors to make the profiles available on them. This file should also be backed up for easy recovery.

Total Station

When you select the **Total Station** instrument type, you will be able to Add, Delete, or Edit a profile for your conventional and robotic total stations. See the [Total Station Configuration](#) topic for more details about configuration for your total station.

For more information on connecting to your instrument please refer to the [Conventional Total Station](#) and [Robotic Total Station](#) topics.

GNSS Reference / GNSS Rover

When you select the **GNSS Reference** or **GNSS Rover** instrument type, you will be able to Add, Delete, or Edit a profile for your GNSS receiver. When you edit a GNSS Rover or GNSS Reference profile, you will see the [Configure Rover](#) or [Configure Reference](#) screens. For more information about using FieldGenius for GNSS surveying, you should review the [GNSS Overview](#) topics.

If you have not purchased the GNSS module for FieldGenius, then you will not have access to the GNSS commands and you will see a "Requires GNSS module license" message.

Disto/Laser

When you select the **Disto/Laser** instrument type, you will be able to Add, Delete, or Edit a profile for your supported Leica Disto and supported Laser Technology Inc devices. Please review the [Dis-to/Laser Reference](#) topic for more details.

Simulators

GNSS Rover Demo

When you select *GNSS Rover Demo* from the **Simulators** instrument type, you will be able to Edit and Connect to a profile for a simulated GNSS Rover receiver. When you edit the RTK Demo profile, you will see the [Configure Rover](#) screen. For more information about using FieldGenius for GNSS surveying, you should review the [GNSS Overview](#) topics.

The *GNSS Rover Demo* will simulate connecting FieldGenius to a GNSS Rover receiver. The coordinates in the GNSS Demo are located outside our office in Westbank, British Columbia, Canada, so to use the GNSS Demo mode you need to set your Coordinate System Settings to UTM Zones, NAD83, UTM83-11, Ellipsoidal.

Total Station Demo

When you select *Total Station Demo* from the **Simulators** instrument type, you will be able to Edit and Connect to a profile for a simulated Total Station. All measurements are manually entered, but point coordinates and the raw file are updated as if connected to an instrument.

None

Use this option if you're not connecting anything to FieldGenius. With this mode, the instrument toolbar will not be displayed in the map screen.

Staking Menu

[Main Menu | Staking](#)

[Instrument Toolbar | Measure Modes | Staking](#)

This menu contains staking related functions.

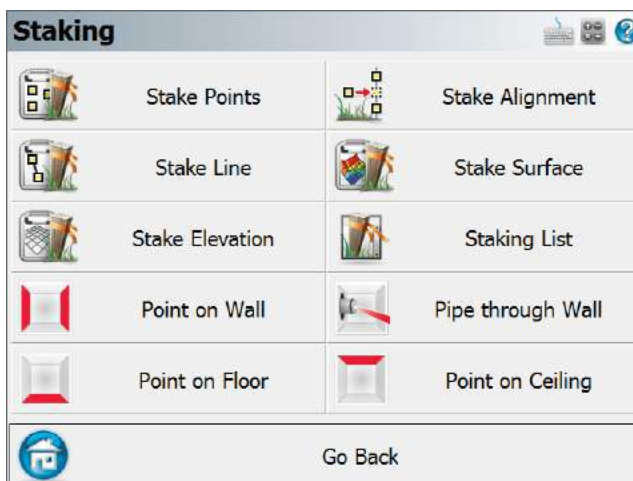

[Stake Points](#)

Use this to stake points from a list or from a screen selection. Please see the [Stake Points](#) topic for more information.

[Stake Line](#)

Use this to stake lines and arcs. Please see the [Stake Line](#) topic for more information.

[Stake Elevation](#)

Use this to stake a specific design elevation. Please see the [Stake Elevation](#) topic for more information.

[Stake Alignment](#)

Use this to open the alignment tools screen. Please see the [Stake Alignment](#) topic for more information.

[Stake Surface](#)

Use this to stake to a DTM (Digital Terrain Model) surface. Please see the [Stake Surface](#) topic for more information.

Staking List

Use this to define a staking list that can be used for staking. Please see the [Staking List](#) topic for more information.

Point on Wall

Use this to auto-locate on the wall surface where an offset point intersects perpendicular. Please see the [Point on Wall](#) topic for more information.

Point on Floor and Point on Ceiling

Use this to auto-locate on the floor or ceiling surface where an offset point intersects perpendicular. Please see the [Point on Floor or Ceiling](#) topic for more information.

Pipe through Wall

Use this to auto-locate on the wall surface the intersection point of the projection of a pipe. Please see the [Pipe Through Wall](#) topic for more information.

Stake Points

[Main Menu](#) | [Staking](#) | [Stake Point](#)

[Point Toolbar](#) | [Stake](#)

Step 1: Select Design Point

When you start the stake points command you will be able to pick a point from the map, or enter a point id in the point id field, or use a point list by turning on the "Use List" toggle.



Point Staking

Point ID: Prev Next



Point Desc: Nearest

Staking List 

Design Point Offset

Direction			
<input e"="" type="text" value="N0°00'00"/>	X	5523092.000m	 Multi-Offset Mode
Distance	Y	311584.000m	
<input type="text" value="0.000m"/>	Z	<input type="text" value="100.000m"/>	

Do not show this screen again.

 Stake Point  Close

Point ID

This allows you to manually enter in the point you would like to stake.

Point Desc

This shows the description of the current design point.

Previous & Next

Use this to automatically advance to the next or previous point in your database. Note that you need to have a value entered in the point number field.

If you have a staking list defined, using these buttons will advance to the next or previous point sequence in the staking list.

Nearest Search

This will automatically select the closet point to stake.

Use List

Use this to force the staking routine to use the staking list you created. If you haven't created a staking list yet, you can press the Edit List button which will take you to the staking list editor.

Edit Staking List

Use this to open the staking list editor. Please see the [Staking List](#) topic for more information.

Offset Direction & Distance

Use this to compute an offset from your design point. If you leave the distance field set to zero, an offset will not be computed. You can use [angle](#) and [distance](#) recall features to help you compute your values.

Northing, Easting, & Elevation

This will display the design coordinates for the point listed in the point number field. If you specify an offset, then the northing and easting will be recalculated based on the offset you entered. The elevation is of the point listed in the point id field, and is not affected by an offset.

Multi-Offset Mode

This feature has been recently added to FieldGenius and allows the user to compute and stake multiple offsets from a single point without having the Point ID automatically increment.

Stake Point button:

If you're using a non-robotic instrument, you will see the "turn to" screen displaying the angle and distance you need to measure to stake the point. Please see section Step 2a below.

If you're using a robotic instrument or GPS, you will see the map screen and the [point staking toolbar](#). Please see section Step 2b or 2c below.

Step 2a: Non Robotic Total Station Layout

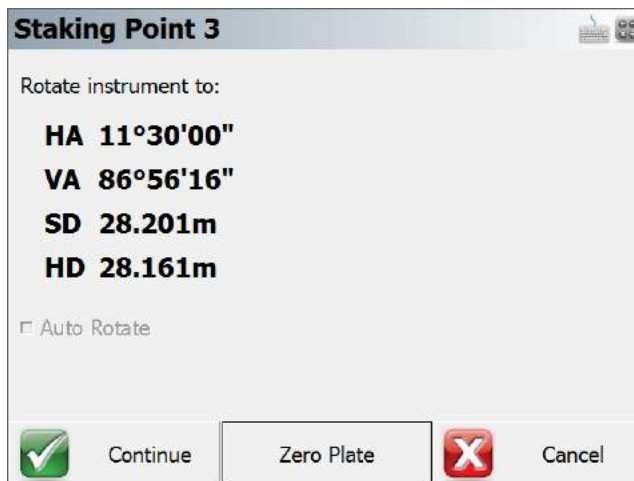

Rotate instrument to:

From this screen you will see what angle and distance you need to turn to on your instrument to stake your point.

At this point you can turn your instrument to match the angles and when ready to start, press the Continue button. The Turn To information is also available on the next screen in case you need to see it again.

Note: Your target height is used to determine the vertical angle for the stake point.

Auto Rotate

If your instrument has servo motors and FieldGenius supports your instrument, this option will be available. It will be on by default and will automatically turn to match both the horizontal and vertical angles needed to stake the point. The instrument will begin to turn when you press the Continue button.

Zero Plate

This is used to modify plate reading on your instrument in such a way that if you manually turn to zero you will be facing towards the point you want to stake.

When you do so, you will see a message "Zero the plate circle to the design point and update the backsight setup?" Press Yes to continue, or No to Cancel. After you press Yes, a new backsight reading is set on the instrument and a BK record is written to the raw file.

You will also note that the turn to angle will now display zero, which is the angle you now need to turn to on the instrument.

You can continue using this for any other points you want to stake. Since the plate reading is changing a lot, you will want to check the backsight frequently to make certain any error meets your tolerances.

Continue

Press this button to continue. You will now see the map screen and the [point staking toolbar](#).

Step 2b: Robotic Total Station Layout

If you're using a robotic instrument and have the [Robotic Staking option](#) enabled, the layout routine will bypass the screen and steps explained in the Step 2a section. Instead, FieldGenius will take you directly to the map screen where you will see our [point staking toolbar](#).

By default, FieldGenius will have the robotic staking option enabled for all robotic total stations.

Some users may need their robotic instrument to automatically turn to the layout point instead. If this is desired, just disable robotic staking.

Step 2c: GNSS Rover Layout

When connected to a GNSS rover, the layout routine will bypass the screen and steps explained in Step 2a. Instead, FieldGenius will take you directly to the map screen where you will see our [point staking toolbar](#).

Staking Toolbar

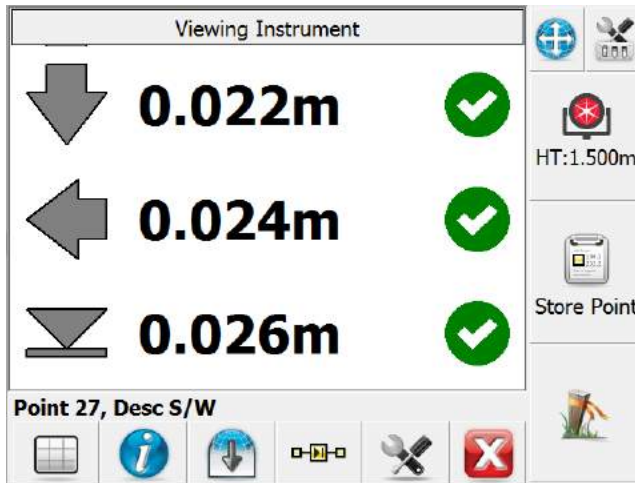

The staking toolbar is used in conjunction with the [Observation Toolbar](#) to help you navigate to your stake point. If you're using a robotic or conventional instrument the staking process will be similar.

The staking toolbar can be accessed by pressing the Stake Point button on the [Stake Points](#) screen. It will also be accessed from many other commands that require a point to be staked.

When you first see the staking screen you may be asked to take a measurement first so it can calculate the current position of the rod. Press the measure button if you're using a conventional instrument, or turn on the cursor tracking button if you're using a robot or GNSS.

You should define a map orientation in the [staking settings](#). Setting this will twist your map view to help you with your stakeout and change the way the "move by" distance are reported. Press the top button "Viewing North/Instrument/Prism" to adjust your Orientation Reference setting. For best results, set the Orientation Reference to Prism for a conventional total station, Instrument for a robotic total station, North for GPNS staking.

Grid Staking Mode is selected by default, select the Grid button on the bottom-left corner will allow you to choose Map staking mode that relies on Observation Toolbar, or Compass staking method if you are using a GNSS receiver or robotic total station.

Note that Compass staking mode for GNSS will require movements to determine the orientation to the point you are trying to stake. Once you are close to the point, the screen will automatically switch to Grid mode for precise staking. The threshold of this switch can be found inside Staking Settings menu.

Buttons



Store Point

When this is pressed the [Store / Edit Points](#) screen will appear so you can store the position of the rod. The default is to store a point in the project database as well as write raw records to the raw file. You might not want to store a point for the staked position but want to have a record of it in the raw file. This can be done by turning off "Store Staked Point" in Stake Settings. (This button not available for GNSS staking, use the Measure button to record the point.)

Viewing Instrument

Select Viewing Direction

This opens up Viewing Direction dialogue where you can select options depending on the current instrument

Current options include: Viewing North/Instrument/Prism/User Point.

Select Staking Method

Depending on the instrument selected, this button allows you to choose from Map, Grid, Compass staking modes.



Staking Information

This displays information about the point you are staking. It will list the coordinates of the point plus other information that will help you during your stakeout.





Toggle Observation View

This button allows you to see or hide the [Observation Toolbar](#).



Select Next Point

This button opens up options to select next point to Stake



Zoom

Map View only - This will automatically zoom to the extents of your current target position and the point you're staking.



Settings

This will open the [Staking Settings](#) screen which allows you to setup parameters that will be used during the stakeout such as your Tolerance, Orientation Reference, and more.



Close

This will close the Staking Toolbar, and return you to the previous screen.

Staking Method - Map View

For each of the following methods, if you are within the Tolerance setting defined in the [Staking Settings](#), then the direction/distance text will be green; if you are outside the tolerance then the text will be red. You can also switch pages within the [Observation Toolbar](#) at any time to see other measurement information, for example if you want to see the rod elevation instead of a Cut/Fill.

Turn An Angle

This method will display both the required and measured horizontal angles in the [Observation Toolbar](#) near the top of the screen. This method is useful while staking with a conventional total station, to quickly get online with the design point.

Directional

This method will display the In/Out and Left/Right (or N/S/E/W), and Cut/Fill distances from the current rod position to the design point in the [Observation Toolbar](#) near the top of the screen. This method is useful while staking with a conventional or robotic total station, but be sure to set the "Orientation Reference" option to Prism for a conventional total station, Instrument for a robotic total station, or North for GNSS staking.

Radial

This method will display the Direction (Bearing or Azimuth) and Distance from the current rod position to the design point in the [Observation Toolbar](#) near the top of the screen. This method is useful while staking with a robotic total station or GNSS.

Conventional Total Station Tips

If you're using a conventional total station you need to press the measure button on the instrument toolbar before the navigate distances are displayed.

To help with navigating, set your map orientation to Prism in the staking settings screen. This will force the map to orientate itself so the prism is at the top and the instrument is at the bottom.

You can use the Turn An Angle method to quickly get online with your point, then switch to the Directional method to navigate accurately to the point.

Robotic Total Station Tips

If you're using a robotic instrument you need to turn on the cursor tracking button on the instrument toolbar before the navigate distances are displayed. Note that with a robotic instrument, there is no need to press the measure button as the cursor tracking provides real-time positions to the Observation Toolbar.

To help with navigating, set your map orientation to Instrument in the Settings screen. This will force the map to orientate itself so the instrument is at the top and the prism is at the bottom.

You can set the EDM mode on the instrument toolbar to use a fine measurement setting that can be used to record the position of the point. When cursor tracking is on it uses a coarse mode which might not be suitable for the storing the point, but suitable enough to for navigation. For precise stakeout you can use the following procedure:

1. Use cursor tracking to navigate to your point.
2. When you attain the position to be staked you can do one of two things:
 - a. If tracking mode is precise enough for your needs you can turn off cursor tracking, then press the Lock button to stop the instrument from tracking the prism. It is useful to do this as the instrument will still be pointed at the stake location and prevents the instrument from following the prism if you have to lay it down.
 - b. If you need to take a more accurate position before marking the point or pounding in your stake: You can turn off cursor tracking, then press the measure button to help you locate the stake point. By doing this it will use the EDM mode set in the instrument toolbar (make certain it is set to a fine mode) instead of using the coarse (tracking) mode. Once the point is located, make sure to press the Lock button to stop the instrument from tracking the prism. It is useful to do this as the instrument will still be pointed at the stake location and prevents the instrument from following the prism if you have to lay it down.
3. Mark your point or pound in your stake.
4. Set the prism on the point you just marked and press the No Lock button which will initiate a search. Since you stopped the instrument from tracking in the previous step the instrument should lock onto the prism very quickly.
5. Press the Measure button to record one final position for the stake point.
6. Press the Store Point button on the staking toolbar to store the final location of the point you just staked.

GNSS Tips

To help with navigating, set your map orientation to North in the settings screen. This will force the map to orient itself so that North remains up on the screen.

Use cursor tracking to navigate to your point (this provides real-time positions to the Observation Toolbar) then when you attain the final position to be staked press the Measure button. The usual GNSS Measurement procedure will apply, and your current tolerance mode and masks will be in effect for the measurement.

Raw File

When you store your point several records are written to the raw file. Following is an example of a point that was staked out:

```
| SP,PN1400,N 715346.319,E 2381454.812,EL1.009,--  
| CF,EL1.0087,GD1.0000  
| DE,PN342,N 715346.319,E 2381454.770,EL1.000,--  
| SD,ND-0.000,ED-0.042,LD-0.009
```

```
| SK,OP251,FP1400,AR180.00000,ZE89.05000,SD63.0500,--Design Point: 342 |
```

The SP record is the point that was recorded when you pressed the Store Point button.

The CF record displays the measured elevation versus design.

The DE record displays the design coordinates for the point to be staked.

The SD record displays the delta values of the staked point. This is the DE record - SP record.

The SK record is the recorded raw observation used to compute the store point (SP) record.

Note: If you turned off "Store Staked Point" in the staking settings, then no SP or CF record will be stored in the raw file.

Stake Line/Arc

Main Menu | Staking | Stake Line

Line Toolbar | Stake

Stake Line

When you start the command from the Staking Menu you will see the [Select Line Toolbar](#) that will allow you to select the object you want to stake.

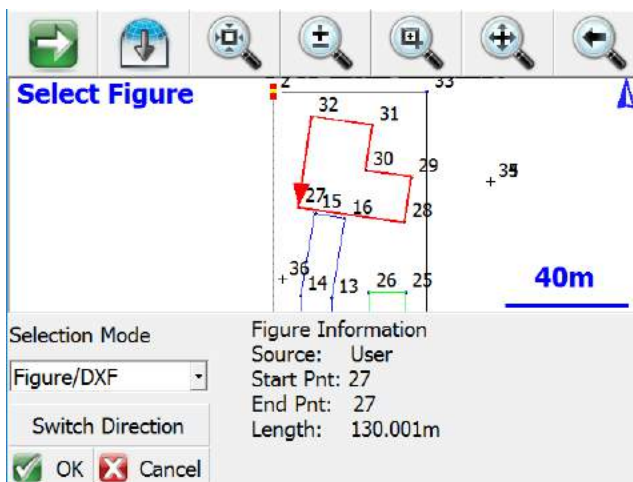

Press OK to continue on to the Line Staking Method screen.

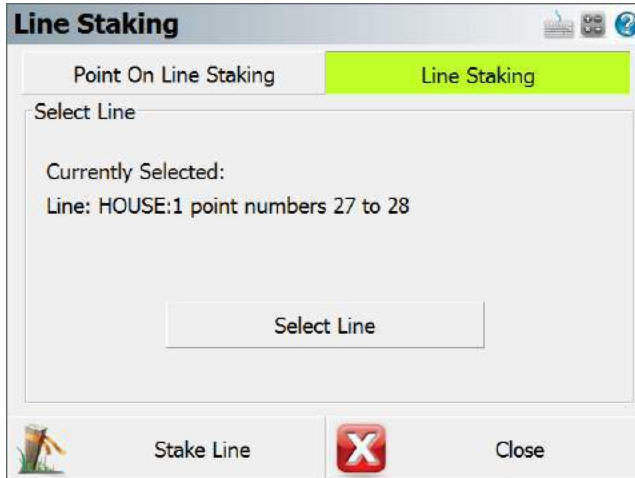

If you want to stake the line, just press the **Line Staking** button which will take you to the Map View screen and wait for an observation to be taken.



If you want to stake a specific point along the line, select the Point On Line Staking button and specify the station/offset distances then press the **Stake Point** button which will display the [stake point toolbar](#) for the specified design point.

When the stake line toolbar opens you have to take a shot before any information will appear on the toolbar.

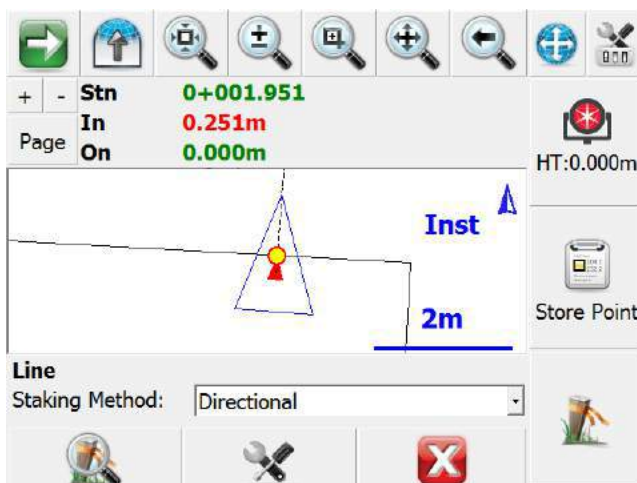

Staking Methods

For each of the following methods, if you are within the Tolerance setting defined in the [Staking Settings](#), then the direction/distance text will be green; if you are outside the tolerance then the text will be red. You can also switch pages within the [Observation Toolbar](#) at any time to see other measurement information, for example if you want to see the rod elevation instead of a Cut/Fill.

Directional

This method will display the current Station (perpendicular from the rod, as marked by a blue circle on the line), the In/Out, Left/Right, or N/S/E/W distance to the line (from the rod to the red x on the line, keeping the same horizontal angle), and the Cut/Fill distance (from the rod to the interpolated elevation of the station point marked by the blue circle, where a cut represents that the rod is higher than the interpolated station elevation, and a fill represent that the rod is lower than the interpolated station elevation) in the [Observation Toolbar](#) near the top of the screen.

When using this method, be sure to set the "Orientation Reference" option to Prism for a conventional total station, Instrument for a robotic total station, North for GNSS staking, or use one of the other reference options if preferred.

You can force FieldGenius to display either In/Out or Left/Right distances by changing the Line Mode option in the [Staking Settings](#).

Stationing - Absolute

This method will display the current Station, Offset, and Cut/Fill distances relative to the line in the [Observation Toolbar](#) near the top of the screen. The station point is marked by a blue circle on the line, the Offset is the Left/Right distance from the blue station point to the current rod position, and the Cut/Fill is the elevation difference from the current rod position to the interpolated elevation of the station point where a cut represents that the rod is higher than the interpolated station elevation, and a fill represent that the rod is lower than the interpolated station elevation.

Stationing - Relative

This method will display the current Station, Offset, and Cut/Fill distances relative to the line in the [Observation Toolbar](#) near the top of the screen. The station point is marked by a blue circle on the line, the Offset is the Left/Right distance from the blue station point to the current rod position, and the Cut/Fill is the elevation difference from the current rod position to the interpolated elevation of the station point where a cut represents that the rod is higher than the interpolated station elevation, and a fill represent that the rod is lower than the interpolated station elevation.

Note:

Please refer to the [Point Staking Toolbar](#) topic for additional information and tips.

Stake Arc

The process is identical whether staking a line or an arc - the only difference is you begin by selecting or defining an arc instead of a line.

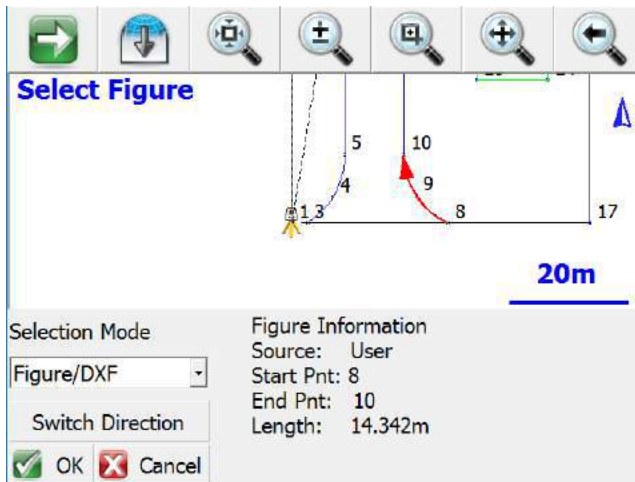

Just like staking to a line, Staking to an Arc gives the user the option to either stake anywhere along the selected arc by selecting the "Line Staking" button. Or the user can also indicate a desired point along the line by selecting the "Point On Line Staking" button and enter in a station and offset.

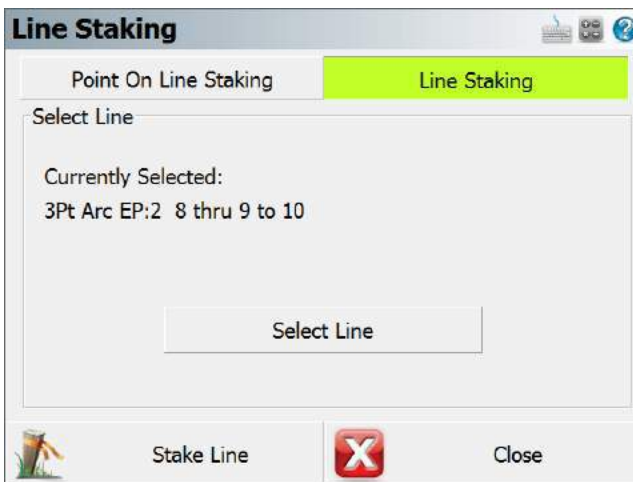

The dialog box is titled "Line Staking" and has two tabs: "Point On Line Staking" and "Line Staking". The "Line Staking" tab is selected and highlighted in green. Below the tabs, the text "Select Line" is displayed. Underneath, it says "Currently Selected:" followed by "3Pt Arc EP:2 8 thru 9 to 10". A "Select Line" button is centered below this text. At the bottom of the dialog, there are three buttons: "Stake Line" with a shovel icon, a red "X" button, and "Close".



The dialog box is titled "Line Staking" and has two tabs: "Point On Line Staking" and "Line Staking". The "Point On Line Staking" tab is selected and highlighted in green. Below the tabs, the "Station" section contains an "Interval" field with "10.000m", a "Start" field with "0+000.000", and a "Stake" field with "0+000.000". There are "Prev" and "Next" buttons to the right of the "Stake" field. The "Offset" section contains an "Interval" field with "1.000m" and a "Stake" field with "0.000m". There are "Left" and "Right" buttons to the right of the "Stake" field. At the bottom of the dialog, there are three buttons: "Stake Point" with a shovel icon, a red "X" button, and "Close".

Stake Alignment

[Main Menu](#) | [Staking](#) | [Stake Alignment](#)

When this is selected, the [Alignment Staking](#) screen will be displayed. Note you first need to define an alignment in the [Road Manager](#) screen. Use this to quickly continue staking your alignment.

Please see the Road Reference section for more detailed information about creating and defining alignments.

[Tell me more about ...](#)

[Road Settings](#)

[Manual Entry - Alignment C/L](#)

[Manual Entry - Vertical Profile](#)

[Manual Entry - Template](#)

[LandXML Cross Sections](#)

[Alignment DTM Surface](#)

[Alignment Staking - Part 1](#)

[Alignment Staking - Part 2](#)

[Alignment Slope Staking](#)

Stake Surface

[Main Menu](#) | [Staking](#) | [Stake Surface](#)

The Stake Surface command allows you to take a shot anywhere on a surface and a cut or fill value will be computed. The current northing and easting position of the rod is based on the measurement, but the Z value is computed by intersecting the surface at the rod location.

You will first be prompted to select a surface to stake. If you have already imported and turned on the TIN or Contours for any surfaces, they will be displayed in the list for you to choose from. If the list is empty, you need to use the Surface Manager to import or enable one. Please refer to the [Surface Manager](#) topic for more information on how to load a surface.

When you first see the staking toolbar you may see the words "Waiting for data" in the Observation Toolbar which means you need to take a measurement first so it can calculate the current position of the rod. Press the measure button if you're using a conventional instrument, or turn on the cursor tracking button if you're using a robot or GPS.



Once you take a shot you will see the following information in the [Observation Toolbar](#) near the top of the screen: the Design elevation based on the surface model's elevation at your rod's horizontal position, the actual Height or elevation of the rod, and the Cut or Fill between the two. To help you visualize where your shot is in relation to the surface you can always use our [3D view](#) capabilities.

Staking Method

Unlike Point or Line/Arc staking, there is only one available staking method: Height.

Store Point

When this is pressed the [Store / Edit Points](#) screen will appear so you can store the position that was staked. Also a raw record will be written to the raw file.

Information

This isn't applicable when staking to a surface and will be grayed out.

Zoom

This isn't applicable when staking to a surface and will be grayed out.

Settings

This will open the [Staking Settings](#) screen which allows you to setup parameters that will be used during the staking process.

Note:

Please refer to the [Point Staking Toolbar](#) topic for additional information and tips.

Stake Elevation

[Main Menu](#) | [Staking](#) | [Stake Elevation](#)

This routine allows you to stake to a specific elevation (called the **Design** elevation). The routine will report the cut and fill values from the selected (Design) elevation to your current rod elevation. The horizontal position is not the focus of this routine.

Why would I want to use this? Maybe you may want to use this function if you have to stake a building pad before concrete is poured and you know what the height of the pad should be. You enter this value in the **Elevation** field and walk around your pad. This routine will inform you of how far your rod is above or below the design elevation.

The first step is to define your constant elevation. You can either type in a design elevation manually into the **Elevation** field, or you can use the **Get elevation from point...** button to select a point from your points database, and use its elevation.

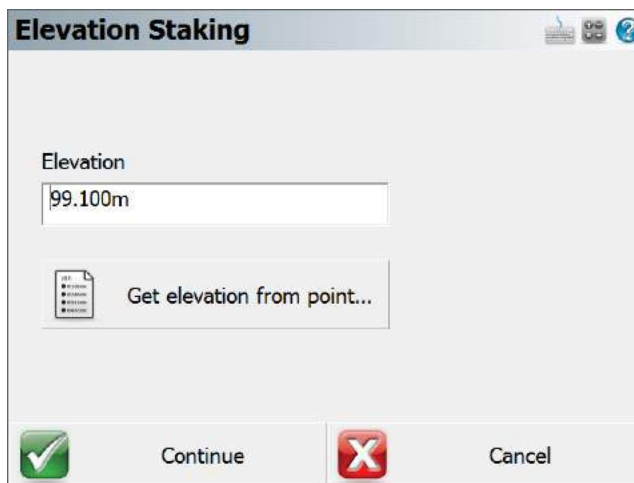

Continue

Press this button to continue to the Map view. You will now see the map screen displaying the [Staking](#) toolbar. The [Display](#) toolbar displays the design elevation (the intended or desired elevation), the actual measured elevation (displayed in the Elev field), and the cut/fill amount required to get to the design elevation from the measured elevation.

Design = Elev + Fill amount or

Design = Elev - Cut amount

Get elevation from point...

Press this button to acquire an elevation from a selected point's elevation. The point database dialog will open and you can select a point to use its elevation.

The **Elev** and **Cut/Fill** text fields will display values that are within your staking tolerance in the colour green. Measurements made outside of your staking tolerance are displayed in the colour red.

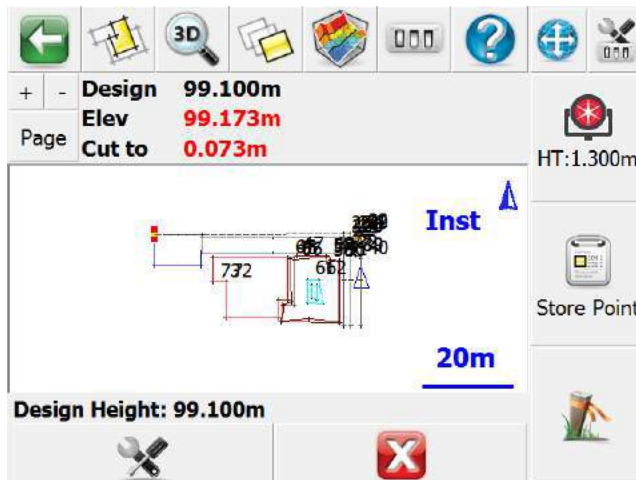

Staking List





[Main Menu](#) | [Staking](#) | [Staking List](#)



Use a staking list to stake points from a predetermined list of points.

Why Use a Staking List?

The staking list is separate from the Points database. We have added intelligence to the staking list specifically for staking out. After importing points and assigning the "To Stake Out" survey role to them, you will never have a measured point appear as a point to be staked out. Moreover, the staking list will always search for and present the next nearest point (shortest path) from the current position as the next point to stake out. This functionality was added to help you stake out more points in a day.

When you start the staking list command you will see the staking list screen and it will be empty, if you haven't previously added any points to it. The image below is of a staking list that contains points.

Staking List		
Point ID	Description	Staked Status
9	HOUSE	
8	HOUSE	
7	HOUSE	
6	HOUSE	
5	HOUSE	

Sort By Point ID		Sort By Shortest Path	
Find Points	Remove Points	Move Up	 Stake Pnt
Select Point	Remove All Points	Move Down	 Close

Sort By Point ID

Use this to sort the staking list by Point ID.

Sort By Shortest Path

Select the first point you want to stake, then use this to sort the staking list by shortest path distance from the selected point.

Find Points

Use this to find points that will be added to the list. You can find points based on the Point ID (which includes the ability to select points based on a window crossing in the mapview screen, by point ID range or by a single point and radius) Coordinate, or Description. The system will look in the Points database for points to add to the staking list.

Find Point Records

Point ID	Coordinate	Description
----------	------------	-------------

Point ID Criteria

Select an Area

Range Example: 1-10, 15, 20..50

Point and Radius

Radius Point

Search Radius

Find Cancel

Find Point Records

Point ID	Coordinate	Description
----------	------------	-------------

Coordinate Criteria

	Minimum	Maximum
Northing	<input type="text"/>	<input type="text"/>
Easting	<input type="text"/>	<input type="text"/>
Elevation	<input type="text"/>	<input type="text"/>

Find Cancel

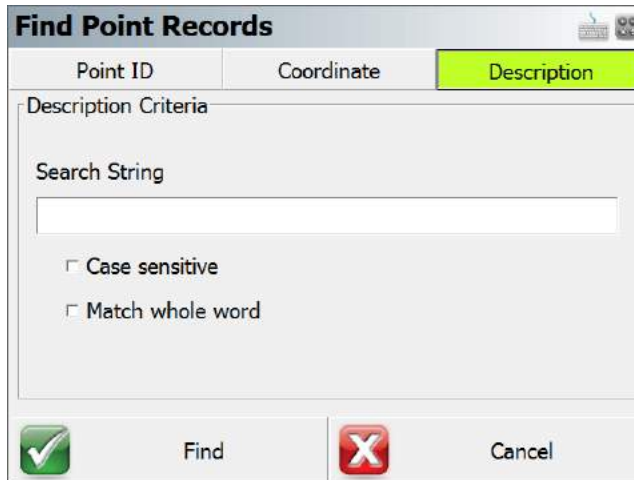

Select Point

Use this to pick a point from the map. Points will be added to the list in the order they're selected.

Remove Points

Use this to delete a single row or multiple rows. This will only remove the points from the list and will not delete any points from the Points database.

Remove All Points

Use this to clear the current list. This will only remove the points from the list and will not delete any points from the Points database.

Move Up

This will move the currently highlighted point up one row.

Move Down button:

This will move the currently highlighted point down one row.

Stake Pnt

This will take you to the staking toolbar to stake out the point that is currently highlighted in the list.

Staking Status

If a point in your staking list has not been staked yet, it will have a stake icon displayed in the Staked Status column. You will see a green checkmark icon if the point has already been staked.

Point ID	Description	Staked Status
1	Nail	
2	Nail	

As you can see in the image above, point 1 has been staked, and point 2 has not.

Adding Points to the Staking List

There are two ways to add points to a staking list. You can add points that already exist in the Points database via the staking list screen by pressing the **Find Points** button. The alternative (and possibly the easiest) way is to assign the survey role of **To Stake Out** to points being imported via the **ASCII Coordinate File Import** button in the [Import/Export Menu](#). When points are imported using the **ASCII Coordinate File Import** button and are assigned the survey role of **To Stake Out**, these points will automatically be added to the staking list.



Working From the List

To work from the list simply highlight the point you wish to stake and press the **Stake Pnt** button which will begin the process. Please see the [Point Staking Toolbar](#) topic for more information. Since you started from the staking list, it will automatically turn on the **"Use Staking List"** checkbox in the [Stake Points](#) screen.

When you store your stake point, the stake point command will automatically go to the next point in the list.

Survey Role Setting

The status of a point is controlled by the Survey Role type in the project database. You can view the role by using the [Coordinate Database](#) viewer. If the point is pending, it will have a survey role type of "to stake out" (point 2 in the image below). If it has been staked, it will have a survey role of staked out (point 1 in the image below).

1		5523958.627m	312330.376m	393.413m
2		5523853.287m	312321.092m	392.877m

Auto-Locate - Point On Wall

[Main Menu](#) | [Staking](#) | [Point on Wall](#)

The Auto Layout Point on Wall mode is only available for the following equipment:

- Leica 3D Disto
- Robotic Total Station such as Leica TS, MS and iCON products

This advanced layout mode allows you to compute the position of a point on a wall using only the non prism EDM mode. The routine will interpolate and determine the location of the wall and will compute the theoretical perpendicular offset from the design point to the plane defining the wall. The laser pointer on your instrument will point to the location that you should mark.

MEP Module

This advanced feature is available when the MEP module is enabled.

Procedure

Define Wall

When you start the routine you will see the Auto-Locate Point on Wall dialog.

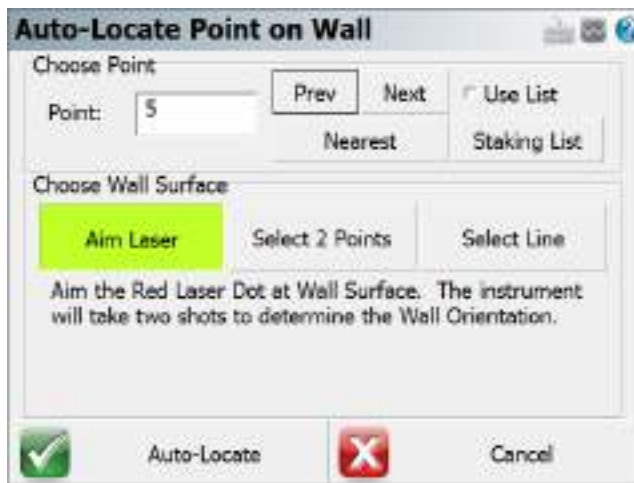

On this dialog you can specify the point you want to locate on the wall, plus define the plane that defines the wall.

The first option allows you to point your instrument at the existing wall and lets the software determine the existing location of the wall by taking some shots automatically to determine the plane.

The second option lets you define the wall by using an existing line in your project or by defining the wall by two points.

Target Heights

When using the auto-locate routines you will not need to use a vertical offset. The routine will always default the vertical offset to "No Vertical Offset" and enable "Use Auto-Location".

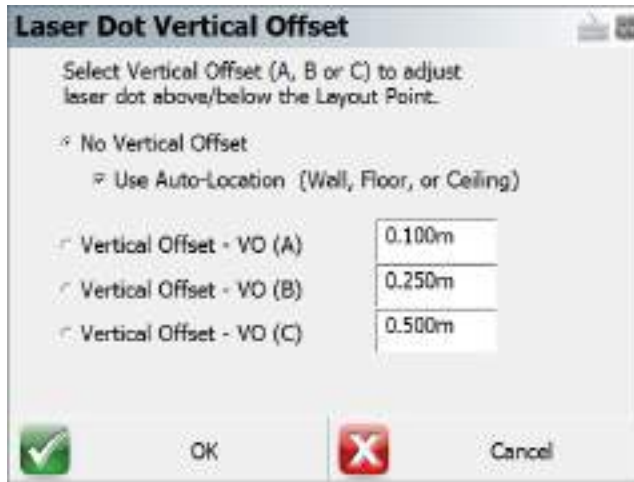

Important Notes

It's important to understand the importance of finding the plane that defines the wall. In the following image you will see that a design point is to be located and marked on the wall. During construction, walls are never perfect and will differ from the design location. Since the laser pointer is being used to locate this point, if all the instrument did was turn to and point at the theoretical position you will see that it would mark a spot clearly in the wrong location.

Layout will prevent this from happening by determining where the wall is by taking several shots to derive a plane. The point is then intersected with this plane and the instrument will then turn to and point directly at the intersection point.

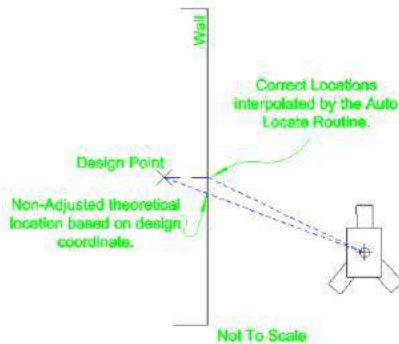

Once the location is marked you can then store it and locate your next point.

Auto-Locate - Point On Floor or Ceiling

[Main Menu](#) | [Staking](#) | [Point on Floor or Point on Ceiling](#)

The Auto Layout Point on Floor and Point on Ceiling modes are only available for the following equipment:

- Leica 3D Disto
- Robotic Total Station with reflectorless capabilities such as Leica TS, MS and iCON products

These advanced layout modes allow you to compute the position of a point on a floor or ceiling using only the non prism EDM mode. The routine will interpolate and determine the location of the floor or ceiling and will compute the theoretical intersection using the x,y location of the point. The laser pointer on your instrument will point to the location of the layout point. Your layout points don't need to have elevations, and only require x,y coordinates.

MEP Module

This advanced feature is only available when the MEP module is enabled on your license.

Procedure

Enable Auto-Location

The user must first enable the Auto-Locate feature to access the MEP functions. To do this go into the Instrument Settings and click on the "Enable Auto-Location" button. This feature will only be available if the license has the MEP module added.

- Note turning the Auto-Location will automatically turn on the instruments reflectorless laser. Ensure the instrument is not pointing in the direction of you or anyone else.

Operating the MEP Routines Point on Floor and Point on Ceiling

These MEP routines are now accessible from the staking window in Layout Mode. Because the MEP functions are all done with the reflectorless laser you will notice the Target Manager option is now disabled from the instrument Tool Panel and only an instrument height is required when orientating.

After the instrument has been orientated, select the point you wish to stake out from the Map View Screen and press the Staking icon and indicate whether you wish to layout the point on the ceiling or the floor. The instrument will then take two shots to determine where the ceiling or floor is and continue to take observations to auto locate the particular point on that plane. The staking results will be displayed in the observations information window. This will also display the vertical distance from the point staked to the plane it has been staked to.

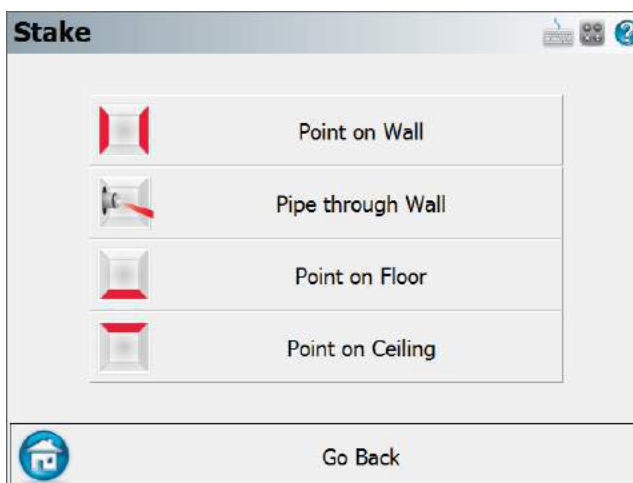

After the user has selected to stake to either the Point on Ceiling or Point on Floor the screen below will now be displayed.

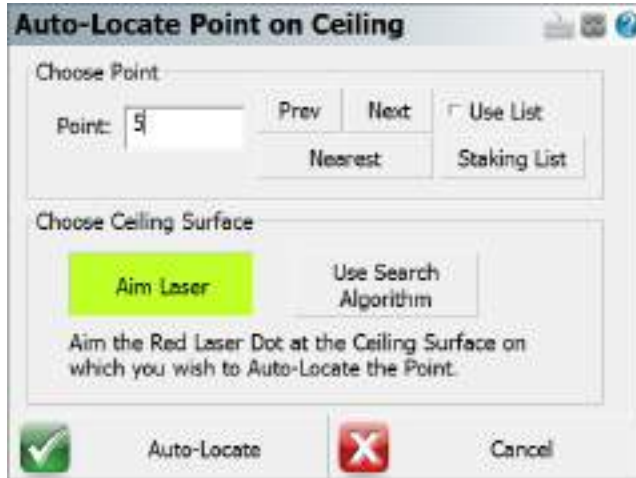

This Auto-Locate options screen allows the user to select how the instrument searches for the point on the plane. It also allows the user to switch the point that needs to be staked.

- Aim Laser - This option will require the user to point the instrument at the desired surface to stake the point to.
- Use Search Algorithm - This option will automatically take as many observations as need to define the surface to stake the point to.



After the routine has located the point on the surface the staking results screen will pop up and will display the point details and also prompt the user to either Store the Point and Continue or Continue without storing. After this has been selected it will take you back to the Stake Point screen for the next point to be laid out.

Target Heights

When using the auto-locate routines you will not need to use a vertical offset. The routine will always default the vertical offset to "No Vertical Offset" and enable "Use Auto-Location".

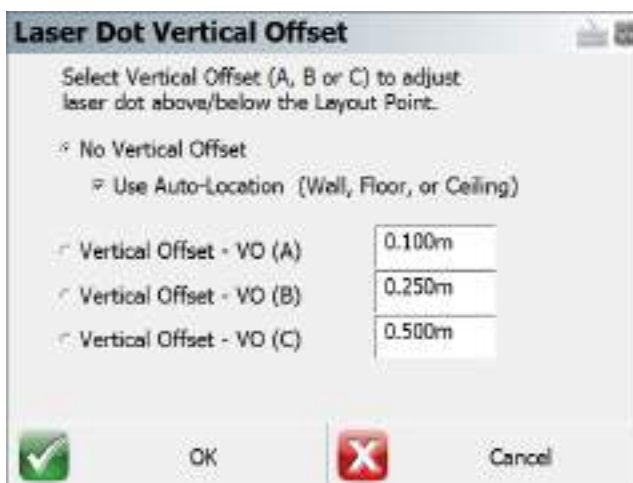

When you start the routine it will automatically start taking measurements on the floor or ceiling depending on the layout mode selected. The measurements will determine a plane that the design point will be projected onto for layout.

Important Notes

It's important to understand the importance of finding the plane that defines the floor or ceiling. In the following image you will see that a point with coordinates (1, 1, 0) is being located on the floor and ceiling. Since the laser pointer is being used to locate this point, if all the instrument did was turn to and point at the theoretical position you will see that it would mark a spot clearly in the wrong location.

Layout will determine where the floor or ceiling is by taking several shots to derive a plane. The point is then intersected with this plane and the instrument will then turn to and point directly at the intersection point.

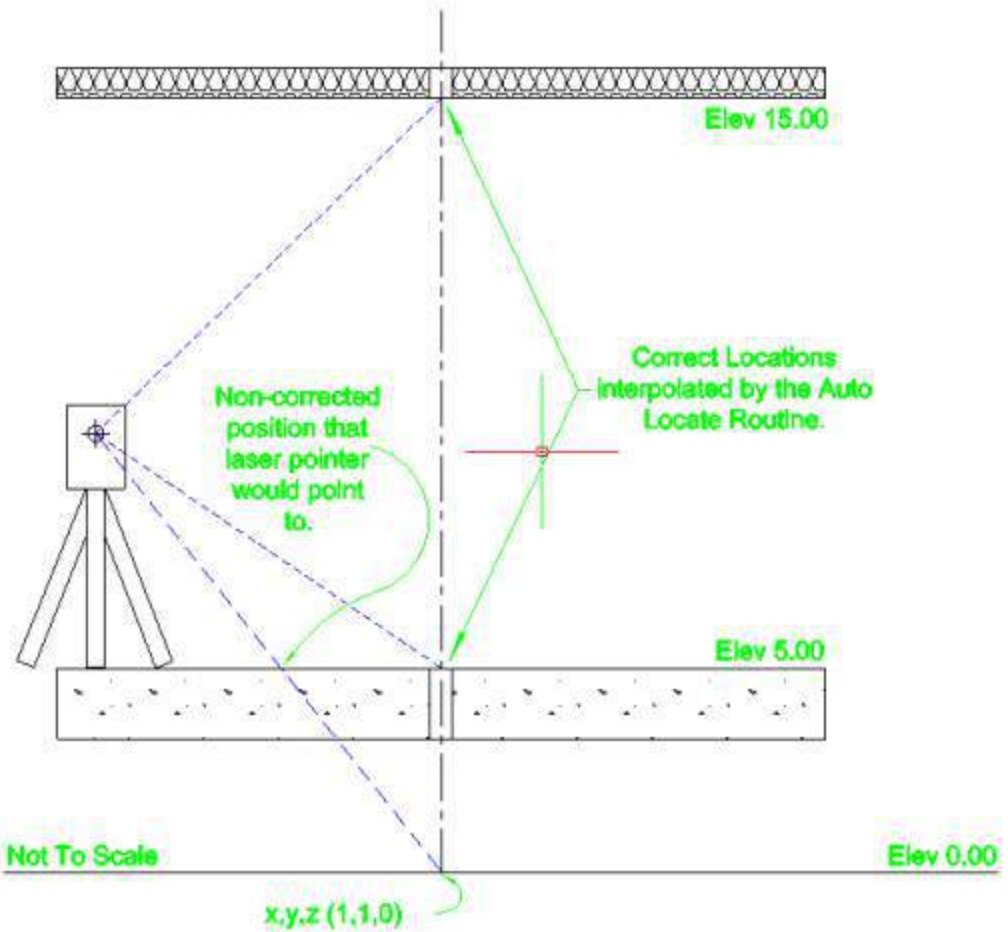

Once the location is marked you can then store it and locate your next point.

Auto-Locate - Pipe Through Wall

[Main Menu](#) | [Staking](#) | [Pipe Through Wall](#)

The Auto-Locate Pipe Through Wall mode is only available for the following equipment:

- Leica 3D Disto
- Robotic Total Station such as Leica TS, MS and iCON products

This advanced layout mode allows you to compute the penetration location of a pipe through a wall using only the non prism EDM mode. The routine will interpolate and determine the location of the wall and will compute the theoretical penetration point and the laser pointer on your instrument will point to the location that you should mark.

MEP Module

This advanced feature is available when the MEP module is enabled.

Procedure

Define Pipe and Wall

When you start the routine you will see the Auto-Locate Point on Wall dialog. On this dialog you can specify the pipe centerline by selecting two points or an existing line in your project.

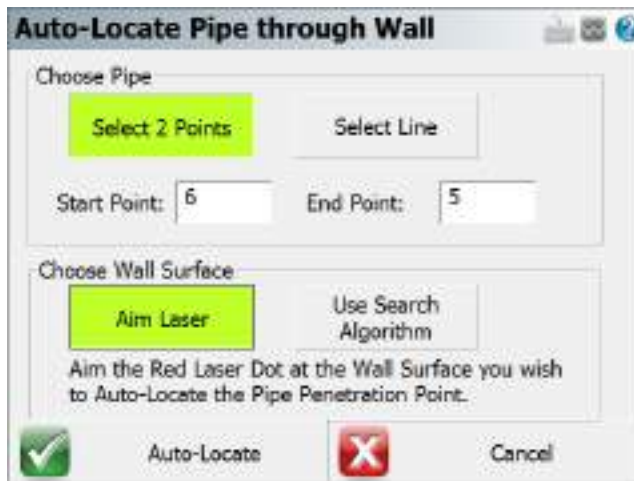

The second option lets you define the wall by pointing at it with your instrument, or by letting the software find the wall automatically.

Target Heights

When using the auto-locate routines you will not need to use a vertical offset. The routine will always default the vertical offset to "No Vertical Offset" and enable "Use Auto-Location".

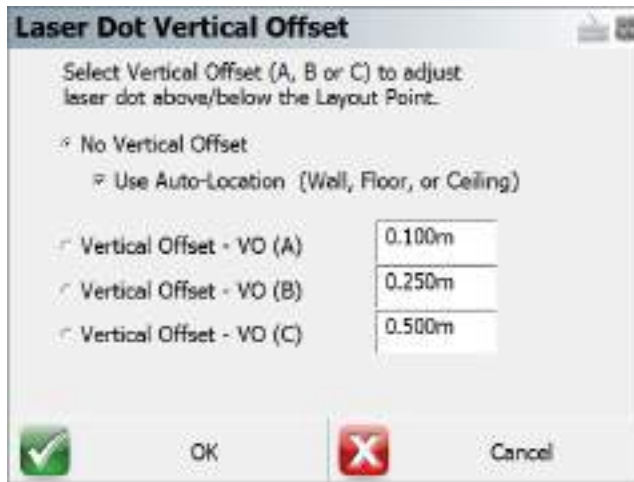

Important Notes

It's important to understand the importance of finding the plane that defines the wall. During construction, walls are never perfect and will differ from the design location. Since the laser pointer is being used to locate the penetration point, the software must determine the current location of the wall.

Layout will determine where the wall is by taking several shots to derive a plane. The pipe line is then intersected with this plane and the instrument will then turn to and point directly at the penetration point.

Import / Export

[Main Menu](#) | [Import / Export](#)

Use this menu to display different options for importing data into or exporting data out of your Project.

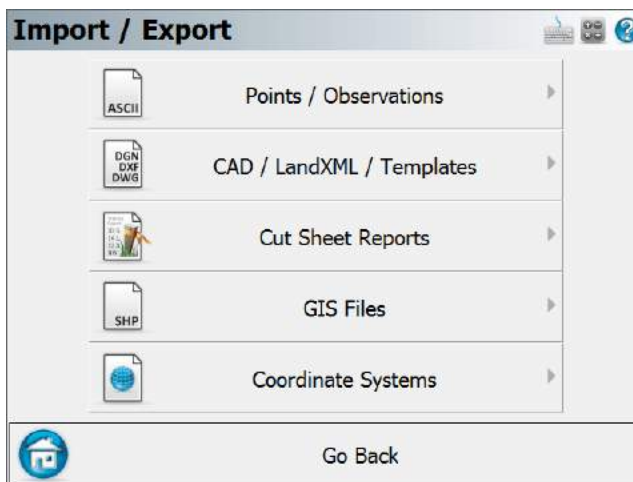

Points / Observations

ASCII Coordinates

You can import and export ASCII coordinates to/from your current Project. Please see the [Import ASCII Coordinates](#) and [Export ASCII Coordinates](#) topics for more information.

SIMA

FieldGenius now supports the importing and exporting the SIMA format. Please see the [SIMA Import](#) and [SIMA Export ASCII](#) topics for more information.

SDR Export

The SDR Export in FieldGenius will convert the existing raw file into a SDR 33 compatible format. Please see the [SDR File Export](#) topic for more information.

Fieldbook File Export

Use this to export a Softdesk FBK file that will contain your coordinates, raw observations and figure information. Please see the [Fieldbook File Export](#) topic for more information.

CR5 Coordinates

FieldGenius now supports the exporting of the CR5 format in both sequential and non-sequential formats. Please see the [CR5 Export](#) topic for more information.

GNSS Survey Report

You can export out a report with important GNSS information relating to the horizontal and vertical system used, individual stored point statistics including satellites used, accuracy and solution type as well as other information relating to the point location. The report will be in PDF or HTML format, depending on your device. Please see the [Survey Report](#) topic for more information.

CAD / LandXML / Templates

DXF/DWG/DGN

Import DXF/DWG/DGN files into your current Project. Please see the [Import DXF/DWG/DGN File](#) and [Map Data Layers](#) topics for more information. When importing in a DWG or DGN files there are some limitations with regards to the file size being imported and the data collector being used. Should you experience any graphical display issues, try importing in a smaller file or unloading the file entirely to clear it up.

Export DXF/DWG files of your current Project. The file will contain drawing entities of your points and lines. Please see the [Export DXF/DWG File](#) topic for more information.

LandXML

Import and export LandXML files. Exported files can contain CgPoints and Chains. The file will be saved in your current Project directory. Please see the [LandXML Import](#) and [LandXML Export](#) topics for more information.

Templates

Import and export templates of figures and points to/from your current Project. Please see the [Import Template](#) and [Export Template](#) topics for more information.

Cut Sheet Reports

FieldGenius can create various cutsheet reports. Please see the [Cutsheet Reports](#) topic for more information.

GIS Files

Shapefiles

FieldGenius now supports the importing and exporting of ESRI shapefiles. Please see the [Shapefile Export](#) topic for more information.

KML Export

FieldGenius now supports the ability to export out a KML file format. Please see the [KML Export](#) topic for more information.

Coordinate Systems

You can import and export user-defined coordinate systems. Please see the [Coordinate Systems](#) topic for more information.

Notes:

- For importing DXF/DWG/DGN, LandXML, and raster image files, please see the [Map Data Layers](#) topic in the [Data Manager](#) menu.
- For importing DTM surface files, please see the [Surfaces](#) topic in the [Data Manager](#) menu.

Points / Observations

ASCII Coordinate Import

[Main Menu](#) | [Import / Export](#) | [Points / Observations](#) | [ASCII Coordinate Import](#)

Use this option to import a list of coordinates to the current Project.

Import Coordinate File

File Name

Field Delimiter

File Format

Assigned Role

Write SP record to raw file
 Overwrite Existing Coordinates

This may be required if a separate coordinate file is uploaded to the device by itself (not as part of a Project with linework). This is also useful for transfer of points from one file to another.

Function

1. Click on the "Browse for File..." button to navigate to and select your file.
2. Choose the field delimiter, either Comma or Space.
3. Choose the file format. See below for more information regarding file format. If you are uncertain, use the **Standard** format.
4. Use the assigned role field to select the survey role of the points being imported. If these points are to go into the staking list, then select **To Stake Out** as the survey role.
5. **Write SP** (Store Point) **record to raw file** will store the imported coordinates to the raw file. This is very useful if you wish to reprocess coordinates later, so we recommend that you select this when importing points.
6. **Overwrite Existing Coordinates** - allows you to control whether points will be overwritten during the import.
7. **Set as Control Points** – will set a flag in the database that will prevent these points from being edited or changed in FieldGenius (under any circumstances!)
8. Choose **OK** to import the coordinates, **Cancel** to abort the import.
9. You will be shown a confirmation of how many points were imported to the current Project.

File Formats

Both space and comma delimited files are supported.

For all formats, the order of the Northing and Easting fields are determined by setting the Coordinate Order in the [Options](#) screen.

Standard

```
| ID, Northing/Y or Easting/X, Easting/X or Northing/Y, Elevation, Descrip- |  
| tion>Note |
```

This format expects the file to be in a standard ASCII format. If your descriptions have a colon in them, then FieldGenius will store everything before the colon as a description, and everything after the colon will be considered to be a note.

Standard with Header

Same as the Standard format, but the first row in the file is ignored.

Extended

```
ID, Northing/Y or Easting/X, Easting/X or Northing/Y, Elevation, Description, Note, Latitude, Longitude, Ellipsoidal Height, Latitude StdDev, Longitude StdDev, Height StdDev
```

This format is different than the standard such that notes are separate from descriptions. Also if you collected GNSS data, the WGS 84 information can also be included and imported along with other information related to the GNSS point.

Extended with Header

Same as the Extended format, but the first row in the file is ignored.

More about the Extended Format

If you import a FieldGenius extended file format ASCII file, FieldGenius will create EP and GS records in the raw file. Also, the coordinates will be imported and stored in the database. Importing this type of file is useful for seeding points when using the OmniStar GNSS system or to create a list of geodetic and cartesian points that you can select while programming a GNSS base receiver.

ID	Northing	Easting	Elevation	Description	Note	Latitude	Longitude	Ell
100	5523097.874	311564.984	399.387	CONTROL		49.83067177	-119.6202724	
101	5523168.871	311529.912	401.188	CONTROL		49.83129864	-119.620794	
102	5523164.192	311507.476	400.85	CONTROL		49.83124955	-119.6211034	
103	5523135.07	311511.185	399.795	CONTROL		49.83098906	-119.6210377	
104	5523099.336	311521.81	399.552	CONTROL		49.83067133	-119.6208728	
105	5523074.024	311506.919	399.233	CONTROL		49.83043923	-119.6210673	
106	5523046.282	311521.379	398.049	CONTROL		49.83019451	-119.620853	
201	5523161.883	311526.004	400.632	CONTROL		49.83123463	-119.6208449	
202	5523159.786	311530.386	400.665	CONTROL		49.83121716	-119.620783	
203	5523167.28	311538.864	401.095	CONTROL		49.83128716	-119.6206689	
204	5523165.261	311551.194	400.946	CONTROL		49.8312729	-119.6204967	
205	5523172.776	311493.661	401.686	CONTROL		49.83132233	-119.6212995	

Importing Cartesian and Geodetic Coordinates

Above is an example of an Extended ASCII file. For the format to work correctly, each point should include Cartesian and Geodetic coordinates for each point. The standard deviations are not needed unless the point is going to be used to "seed" a position for use with the OmniStar/VBS system. **The Latitude and Longitude values are required to be stored in decimal degrees.**

So if this type of file is imported into FieldGenius the following will occur:

- A point is stored in the Project database using the Cartesian Coordinates.
- A GS record is written in the raw file using the Cartesian Coordinates as a reference.
- An EP record is written to the raw file using the Geodetic Coordinates as a reference.

Importing Geodetic Coordinates Only

You can create an Extended ASCII Point file that only contains a point number, description, note and Geodetic coordinates. Upon import FieldGenius will use the Geodetic coordinates and your defined coordinate system in your [coordinate system settings](#) to compute Cartesian coordinates to be stored in the database.

So if this type of file is imported into FieldGenius the following will occur:

- Using the horizontal and Vertical datum settings you've defined in your [coordinate system settings](#), FieldGenius will compute a Cartesian coordinate for each point using the Geodetic values imported from the ASCII file.
- A point is stored in the Project database using the Cartesian Coordinates that was computed. The point will be assigned the point number that was imported from the ASCII file.
- A GS record is written in the raw file using the Cartesian Coordinates as a reference.
- An EP record is written to the raw file using the Geodetic Coordinates as a reference.

ASCII Coordinate Export

[Main Menu](#) | [Import / Export](#) | [Points / Observations](#) | [ASCII Coordinate Export](#)

Use this option to export a coordinate list from the current file.

This is useful for transfer of points from one file to another.



Function

1. Specify a range of point to export in the form **##.##**. Accept default of **All** if desired.
2. Specify the number of decimal places to carry on the export. (maximum=6)
3. Specify if you want to export them with either a space or comma delimiter.
4. Specify the Angular format.
5. Specify the Encoding format.
 - ANSI - This is the default format for ASCII, which is compatible with majority of the CAD programs such as Autodesk products.
 - UNICODE - This is for use with non-English characters in the Description or Note fields.
6. Include Header will add a header row to the exported file.
7. Include Averaging Measurements - This will include all the temporary observations of all the averaged points into the exported file
8. Choose the file format type that you want to use. See below for more details about the different file formats. If you are uncertain, use the **Standard** format.
9. Choose **Export** to export the coordinates, or **Cancel** to abort the export.
10. Browse to the folder where you want to save the file, enter a filename including an extension, then press **Save File**. FieldGenius will not add any extension to the filename you enter.
11. You will be shown a confirmation of how many points were exported.

File Formats

Both space and comma delimited files are supported.

For all formats, the order of the Northing and Easting fields are determined by setting the Coordinate Order in the [Options](#) screen.

Standard

```
ID, Northing/Y or Easting/X, Easting/X or Northing/Y, Elevation, Description:Note
```

This format will append any notes you have to your description, separated by a colon.

FieldGenius has recently added two check boxes to include the Header and the Averaging Measurements to the ASCII file when exporting.

Extended

```
ID, Northing/Y or Easting/X, Easting/X or Northing/Y, Elevation, Description, Note, Latitude, Longitude, EllipsoidalHeight, LatitudeStdDev, LongitudeStdDev, HeightStdDev
```

This format is different than the Standard such that notes are separated from descriptions.

If you collected GNSS data, the WGS 84 information will also be exported along with other information related to the GNSS point. The WGS 84 information will be extracted from your GS records in the raw file.

Extended with Header

Same as the Extended format, but with Header data in the first row.

CST

This is a predefined format intended for Leica ELLIPSE Neo software

Custom Formats

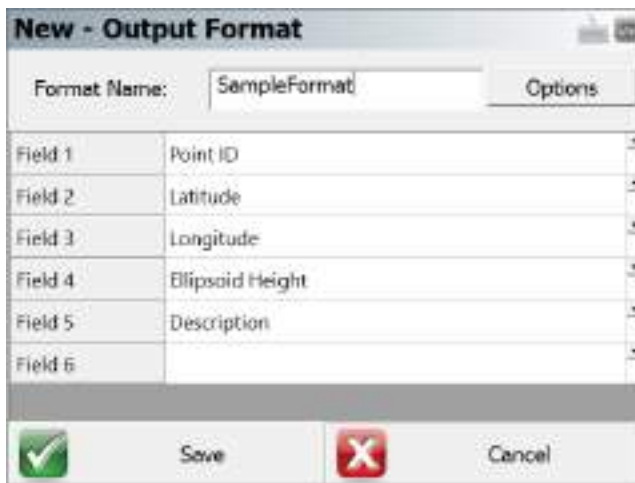

FieldGenius has the option to create a customized ASCII file for exporting. This option allows the user to add additional information to the standard ASCII file format. Simply click in the grey area to add in an extra info line and select what you wish to add in from the pull down menu.

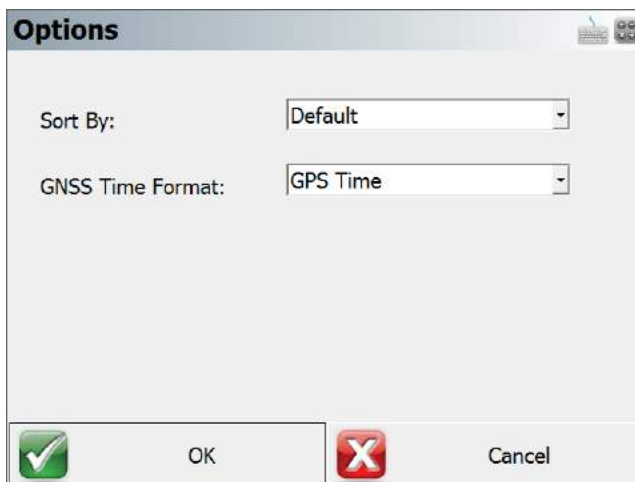

There is also an "Options" button in the upper right corner where you can specifically request the ASCII file to either sort by Point ID or Measurement type as select what GNSS time format.

More about the Extended Format

If you import a FieldGenius extended file format ASCII file, we will create EP and GS records in the raw file. Also, the coordinates will be imported and stored in the database. Importing this type of file is useful for seeding points when using the OmniStar GNSS system.

There is more detailed information about the extended format in the [ASCII Coordinate Import](#) topic.

SIMA Import

[Main Menu](#) | [Import / Export](#) | [Points / Observations](#) | [SIMA Import](#)

FieldGenius supports importing coordinates stored in SIMA format. SIMA is a Japanese domestic standard.

SIMA Export

[Main Menu](#) | [Import / Export](#) | [Points / Observations](#) | [SIMA Export](#)

FieldGenius supports exporting coordinates in SIMA format. SIMA is a Japanese domestic standard.

SDR Export

[Main Menu](#) | [Import / Export](#) | [Points / Observations](#) | [SDR Export](#)

The SDR Export in FieldGenius will convert the existing raw file into a SDR 33 compatible format. It is important to note that currently not all existing raw record types are exported through the SDR export.

Currently the following types are exported:

- Store Points
- Job Info
- Units
- Notes / Comments
- Occupy Setups
- Sideshots
- Stakeout shots
- Target Heights
- Resection measurements are not exported, but computed resection point exported as Store Point.
- The resulting SS or TR shot for multisets will be exported as a sideshot.
- The resulting SS or TR shot for angle or distance offsets will be exported as a sideshot.
- Calculated points will be stored as a Store Point
- Adjusted Points are exported as Store Points

The following record types are not currently exported:

- GNSS Datum Settings
- GNSS Transformation Parameters
- GNSS Measurements

Fieldbook Export

[Main Menu](#) | [Import / Export](#) | [Points / Observations](#) | [Fieldbook Export](#)

Use this option to export FieldGenius database points and figure information from the current project in a Fieldbook (.FBK) format for import into non-MicroSurvey desktop software such as AutoCAD's Land Development Desktop.

FieldGenius users who have MicroSurvey CAD or inCAD Desktop software will not need to use this function as our products import standard FieldGenius raw data.

This function is designed for post processing so is best used after all fieldwork is complete. The raw file observations are not included in the FBK file, you can read the FieldGenius raw file into Survey Link included with LDD. You can then make your edits to the raw file and import it to LDD.

Importing into LDD

To import the FBK file into LDD you will need to use the Import Field Book from the Data Collection / Input menu.

If you haven't already done so you will want to edit your Description Key list and Figure Prefix Library in LDD so the points and figures will be automatically layered for you.

Export CR5 (Sequential)

[Main Menu](#) | [Import / Export](#) | [Points / Observations](#) | [CR5 Export \(Non-Sequential\)](#)

This option creates a non-sequential binary CR5 file of all the points in the coordinate database.

Export CR5 (Non-Sequential)

[Main Menu](#) | [Import / Export](#) | [Points / Observations](#) | [CR5 Export \(Sequential\)](#)

This option creates a sequential binary CR5 file of all the points in the coordinate database.

GNSS Survey Report

[Main Menu](#) | [Import / Export](#) | [Points / Observations](#) | [GNSS Survey Report](#)

Creates a report in PDF format (if FieldGenius is running on a Windows PC/Tablet) or HTML format (if FieldGenius is running on a mobile device). The report includes information about the project, settings, and GNSS survey information.

Below is a sample of the Point information included in the report.

-----Reference Information-----

Reference ID: 53
 Mount Point: OLMP23
 Reference Format: RTCM2
 Latitude: N47°02'41.43501"
 Longitude: W122°53'42.72349"
 Ellipsoid Height: 9.695'

-----Measured Points-----

Antenna NGS_ID:	"APSAPS-3	NONE"	
NGS_L1:	90.6mm	NGS_L2:	81.2mm
Point ID:	100	Description:	
Antenna Height:	6.562	Solution:	RTK Fixed
No. Satellites:	16	No. Epochs:	180
GPS Start Time:	22:04:07		
Northing:	24643.9478	RMS North:	0.0096
Easting:	1147073.2874	RMS East:	0.0130
Elevation:	59.1132	RMS Elev:	0.0245
HDOP: 0.7	VDOP: 1.1	PDOP:	1.35

CAD / LandXML / Templates

DGN/DXF/DWG Import

[Main Menu](#) | [Import / Export](#) | [CAD / LandXML / Templates](#) | [DGN/DXF/DWG Import](#)

Use this function to import CAD DXF files into a FieldGenius Project.

FieldGenius supports all Point nodes, Lines, Arcs, Polylines, Text and 3D Faces in the DXF file.

FieldGenius does not support Blocks or any other entities not mentioned above in the DXF file.

All items from the DXF file will be drawn in their respective layers as defined in the DXF file. These layers may be toggled on and off using FieldGenius's layer manager.

Importing Steps

1. From the main menu, press the **Data Manager** button then the **Map Data Layers** button.
2. Press the **Add File** button on the Layer Manager.
3. Using the browse window, find the DXF file you would like to import and press the **Open File** button.
4. Use the Layer Manager to turn on or off any layers you don't want to view.
5. Press **Close** and return to the map view.
6. Press the zoom extents button to see your entire DXF file.

For more information on the layer manager please visit the [Layer Manager](#) topic.

Important Notes:

- Your CAD desktop system likely has a super fast processor and 1GB or more of RAM but most current Windows CE devices run at 206Mhz and have 32 or maybe 64MB of RAM. For this reason, you will not be able to manipulate a 5MB DXF file with the same speed as your desktop system so minimize the size of the DXF files for most efficient operation.

- TEXT is the biggest performance reducer in your DXF files. For best performance, minimize the amount of text in the DXF files or turn off layers containing text when not needed.

DXF/DWG Export

[Main Menu](#) | [Import / Export](#) | [CAD / LandXML / Templates](#) | [DXF/DWG Export](#)

Use this to export your current FieldGenius drawing as a DXF or DWG file. This allows for easy import of linework and nodes into most cad or graphic systems

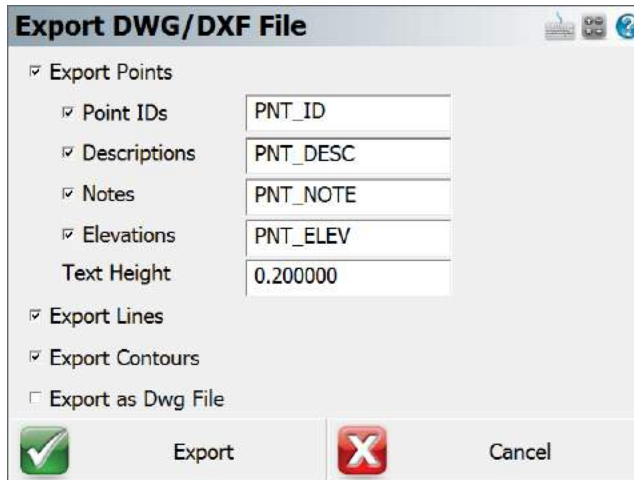

Function

1. Select the options for your DXF file.

Export Points: If this is checked, your coordinate point nodes will be exported to the DXF file. You can also specify what layer you want the labels to go on and a default text height.

Export Lines: If this is checked, all figures (lines, arcs, and splines) will be exported to the DXF file.

Export Contours: If this is checked, all contour lines drawn using the [Surface Manager](#) will be exported to the DXF file.

2. Click **Export**.
3. Browse to the folder where you want to save the file, enter a filename, then press Save File. FieldGenius will add a .dxf extension to the filename if you did not include it.
4. The DXF file is created and you can copy it to your desktop computer.

Notes about DXF files:

- Upon export, FieldGenius will compare the figure name to see if it has a match in the AutoMap file. If it does, FieldGenius will draw the points along the figure, as well as draw the figure on the layer specified in the AutoMap library.
- Points that are exported will match the point color settings set in the AutoMap library.
- Figures that don't have a match in the AutoMap library will be drawn on a layer named "Default". Color setting will be set to 256.
- Points or nodes will be 2D or 3D depending on the Z value.
- Lines will be 2D or 3D depending on the Z values of the end points.
- Figures will be drawn as polylines.
- Curvy lines or arcs will be drawn as segmented polylines. FieldGenius will automatically interpolate an elevation along the arc or curved section of the figure at 1° intervals.
- Contours will be drawn as polylines and will be 3D based on the contour elevation.
- Points or nodes will appear as an "X" marker in the DXF file because the PDMODE variable is being set to 3 in the DXF file. In most desktop CAD programs you can change this marker type by typing PDMODE.

LandXML Import

[Main Menu](#) | [Import / Export](#) | [CAD / LandXML / Templates](#) | [LandXML Import](#)

FieldGenius can import LandXML files. Rather than convert these files into some different format, you can read these files directly into FieldGenius.

Importing a LandXML File

There are several different methods of importing a LandXML file:

- By using the Import LandXML File command.
- By using the Data Manager | Map Data Layers | Add File command.
- By placing a LandXML file into a Project folder. This is normally done by desktop software like MicroSurvey CAD or inCAD. If FieldGenius finds a LandXML file that has the same name as the Project, and it is in the Project folder, then it will automatically be imported when you load the Project.

When a LandXML file is read, it is scanned to make a list of the objects that it contains. Loading the entire file into the FieldGenius Project could use many megabytes of valuable memory. Therefore, when you wish to use data from a LandXML file, you need to load it as needed. Sample LandXML files are available at the LandXML web site: www.landxml.org

One of the example files posted is subdivision-xsec.xml. We have downloaded and are now going to show the results of reading it into FieldGenius:

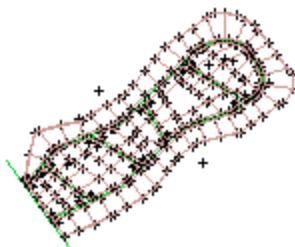

LandXML Components and How to Use Them

There are many different types of objects in a LandXML file. FieldGenius will be expanding the use of these objects as the program grows.

As of the date this manual was written, the following objects are supported. This list will change, so you may notice other options on the smart menus for these objects.

CgPoints

A LandXML file can contain many different sets of points. The LandXML specification requires that every point in a LandXML file have a different id. For example you cannot have two CgPoint sets containing a point with the same id. Since a LandXML file can contain many different CgPoint sets, and these point sets may contain thousands of points, FieldGenius lists these sets in the Project Manager. When you want to see them on the screen, you need to use the Smart Menu to Load the CgPoint Sets.

By default when you import your LandXML file, the CgPoints will be displayed on the screen. CgPoints are not stored in the database but they can be used by our commands. For example you can use the Occupy Point command and select the CgPoints with the point chooser for the setup and backsight points. You can also consider them to be read only points.

Surfaces

Surfaces can be imported into FieldGenius from a LandXML file. The surfaces can be imported in two ways:

- Fast: We can use the points that define the surface and let FieldGenius re-calculate the TIN model. This might be acceptable for an area where no attempt was made to edit the triangles or add break lines. FieldGenius can compute a surface in seconds from large numbers of points.
- Maintain Triangulation: we can force FieldGenius to read the TIN exactly as computed by the desktop software. This requires much more computing by the import program, but it will exactly maintain the triangulation in the original surface. For example, if the LandXML surface was created by using breaklines and hand editing, you will want to maintain the exact triangles for staking and viewing the surface.

You can set the import method by going to the Main Menu | Data Manager | Surfaces | [Surface Options](#).

From the [Surface Manager](#) you can see a list of the surfaces in the XML file. Select the one you want to load.

Alignments, Profiles, and Cross Sections

Alignments, cross sections, and staking of these items are some of the powerful features in FieldGenius. Almost all modern road design software will export alignments in LandXML format. We read the horizontal alignment (which is normally at elevation zero), the vertical profile, and the cross sections from LandXML files. Individual components can be selected for staking or viewing information. The Project Manager is used for visibility of these items, and you can drill down into the components right to the coordinate level.

Reading the basic alignment information is done when you import the LandXML file. Alignments generally are not too large, so we read the alignment, profile and cross sections into memory for later use. There may be several surfaces in an alignment, so you can view each cross section surface separately. Each may be staked. In this sample file, there are several alignments. Each alignment can be turned on or off, or just the cross sections for an alignment can be turned off.

Following is a tiny excerpt from the first few lines of this LandXML file. Fortunately, it is rarely necessary to open a file; however, if you open one in Internet Explorer, you will see the format. They are easily explored, because you can "collapse" sections of the file by picking on the negative signs at the beginning of the lines in Internet Explorer. In this picture, all of the file has been collapsed except for the header. It is easy to see that the file was created by Autodesk Land Desktop version 3 with Service Pack 1 installed.

```

<?xml version="1.0" ?>
- <LandXML xmlns="http://www.landxml.org/schema/LandXML-1.0"
  xmlns:xsi="http://www.w3.org/2001/XMLSchema-instance"
  xsi:schemaLocation="http://www.landxml.org/schema/LandXML-1.0
  http://www.landxml.org/schema/LandXML-1.0/LandXML-1.0.xsd" version="1.0"
  time="10:08:09" readOnly="false" language="English">
  <Project name="subdivision" />
+ <Units>
+ <Application name="Land Desktop" manufacturer="Autodesk" version="3 - Service Pa
  manufacturerURL="www.autodesk.com">
+ <CgPoints>
+ <Surfaces>
+ <Parcels>
+ <Alignments>
</LandXML>

```

Parcels/Lots

Parcels are displayed in the graphics when you import a LandXML file. You can select the lines to get basic information, and you can drill down into the Project Manager to see more details. The points that define a Parcel are stored in the CgPoints section of the LandXML file. If you want to see the point numbers on the screen, then you need to load the CgPoints. If you want to stake the points, then you need to load the CgPoints into the Points DB.

Chains/Figures

These LandXML items may or may not appear, because a chain can cross from one CgPoints set to another. This means that if you do not have all the CgPoint sets loaded, then the chains cannot appear.

LandXML Export (Points and Chains)

[Main Menu](#) | [Import / Export](#) | [CAD / LandXML / Templates](#) | [LandXML Export \(Points and Chains\)](#)

Writes a LandXML *.xml file, including CgPoint records of the point coordinates and Chain records of the figures in the current Project.

Import Template

[Main Menu](#) | [Import / Export](#) | [CAD / LandXML Templates](#) | [Import Template](#)

If you have a template file saved you can import it back into your project. When you start the command you will see the file browse dialog that allows you to find and open the template file. After which you will see the template import toolbar. If you need to create a template file, refer to the [Template Export](#) topic.

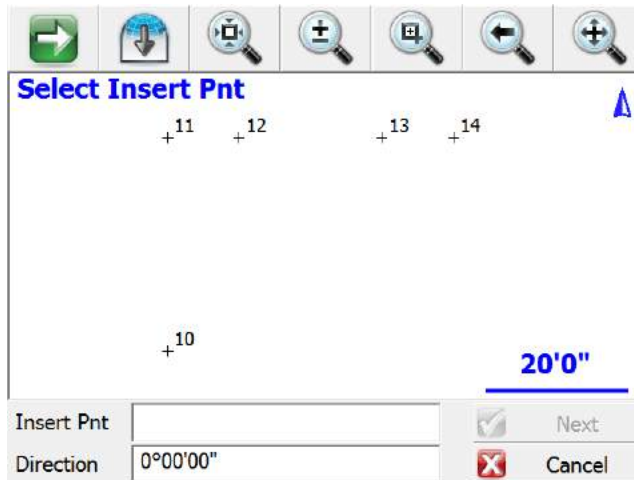

Select Insertion Point

After you select the template you can select the insertion point in the map screen, and also define a rotation for the template. A preview of the template will be displayed in the map screen in green, press Next to continue.

Select Origin Point

After you specify the insertion point, you can then choose the origin point. Select points (green dots) on the template preview to define a new origin position.

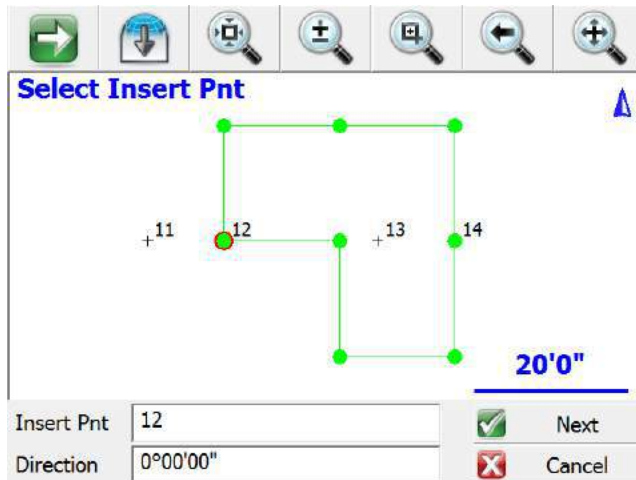

Insert Template

Once you are satisfied with the location and rotation of the template, you can save it into the current project by pressing the Insert button. New points and line work will be added to the project for you automatically.

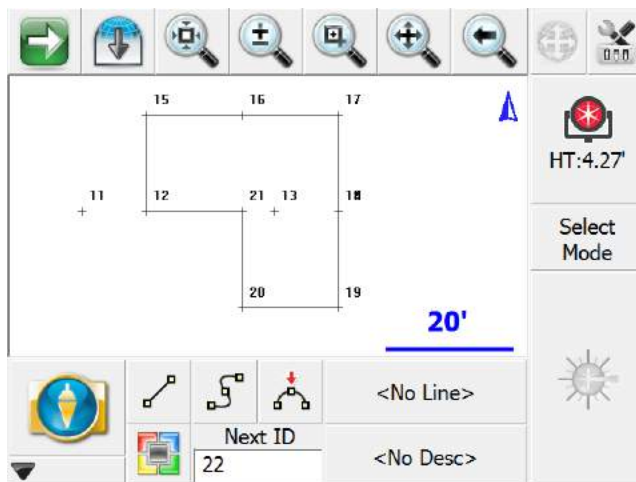

Export Template

[Main Menu](#) | [Import](#) / [Export](#) | [CAD](#) / [LandXML](#) / [Templates](#) | [Export Template](#)

You can export and save line work (figures) and points to a file that can then be inserted into different projects. An example of how this feature can be used is when you have a building that is common to several projects. Instead of computing a new building in each project, you can do it just once, save it to a file, then insert it into your other projects.

When you start the command you will see the template export toolbar.

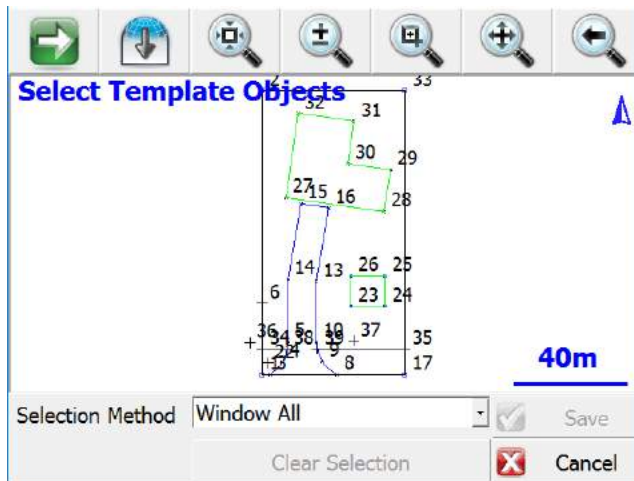

There are four options available for selecting the line work and points.

Window All

This option lets you window the objects. All points and line work contained within the selection window will be accepted.

Window Points

This option lets you window objects, but only coordinate points will be selected all line work is ignored.

Single All

Use this option to manually select objects in the map view to export. You can select points or lines / arcs. If you select a line, the points that define the line will be exported as well.

Single Points

Use this option to select point one by one in the map screen.

Save Template

When you're done selecting your objects, you can save them to a file by pressing the Save button. Choose a location for your template, give the file a descriptive name and save it. Template files have a ".tpl" extension.

Cut Sheet Reports

[Main Menu](#) | [Import / Export](#) | [Cut Sheet Reports](#)

FieldGenius includes a cut sheet generator. When you stake points or alignments, cut sheet records are recorded in the raw file.

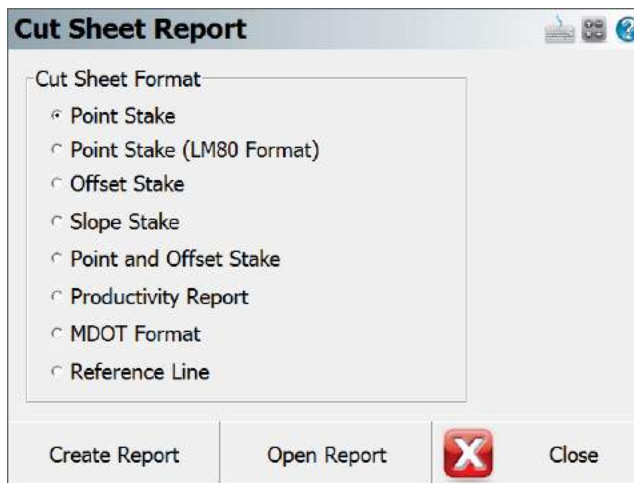

The different cut sheet formats will be described below. To create a cut sheet, select the desired cut sheet format, then press the **Create Report** button, then choose the folder and filename for it. You can give it any extension (one will not be automatically added) but we recommend using either .CSV or .TXT. The extension you provide will not affect the contents of the file in any way.

If you've already created a cut sheet and want to open it to review it, press the **Open Report** button.

FieldGenius automatically creates a (.CSV) comma separated value file for each cut sheet format you create. This file can be read into Excel, which will allow you to format it and print it. The records stored during staking follow the RW5 format so cut sheet records can be created using software packages that support this format.

Point Stake Format

If you've staked points using the [Stake Point](#) command you will be able to create a stake point cut sheet report.

Design Pt	As Built Pt	Cut(-)/Fill(+)	Design N	Design E	Design El	Delta N	Delta E	Design Desc	As Built Desc
17	5005	0	5007.202	5003.499	100.202	0	0	GRD	Design Pnt 17
19	5006	0	5006.076	5001.161	100.119	-0.007	0	GRD	Design Pnt 19
20	5007	0	5008.335	4998.831	100.061	-0.007	0	GRD	Design Pnt 20
51	5009	-0.001	5006.573	4992.566	99.815	-0.001	-0.001	GRD	Design Pnt 51
51	5010	-0.001	5006.573	4992.566	99.815	-0.001	-0.001	GRD	Design Pnt 51
30	5011	-0.425	4997.663	4996.693	99.815	-6.249	14.371	E/ASPH	Design Pnt 30
31	5012	-0.739	4996.107	4991.625	99.502	-7.805	9.302	E/ASPH	Design Pnt 31

LM80 Format: This option will format the cut sheet in the LM 80 format.

Offset Stakes Format

If you've staked points using the [stake alignment](#) command, you can create a cut sheet report for your station and offset stakes.

Station	Offset	Offset Length	Cut(-)/Fill(+)	Elevation	Grade	Description
1	Left	1.002	0	100.1662	100.1665	0+01.00 L 1.000
2	Left	0.984	0	100.0624	100.0619	0+02.00 L 1.000
2	Center	0.001	-0.001	100.0629	100.0619	0+02.00 C 0.000
2	Right	1.005	0	100.0622	100.0619	0+02.00 R 1.000
3	Left	1.001	-0.007	99.9643	99.9574	0+03.00 L 1.000
3	Right	0.006	-0.014	99.9715	99.9574	0+03.00 C 0.000
3	Right	1.002	-0.005	99.9619	99.9574	0+03.00 R 1.000

Slope Stake Format

If you've staked points using the [slope stake alignment](#) command, you can create a cut sheet report for your slope stakes.

Station	Offset Direction	Cut/Fill	Design Slope	Offset Length	Pt Name	Actual EI	Design EI	Ahead On Station	HD to Hinge Pt	VD to Hinge Pt	HD to Center Line	VD to Center Line	Observed Slope	Description
12	Left	Cut	1.00:1	N/A	81	99.984	100.24	-0.032	1.011	0.968	2.011	0.968	1.04:1	CP 0+012.000 L 1.000
6	Left	Cut	1.00:1	N/A	5000	100.15	100.15	-0.013	0.507	0.501	1.507	0.501	1.01:1	CP 0+06.00 L 1.000
6	Left	Cut	1.00:1	N/A	5001	100.15	100.15	-0.002	0.498	0.501	1.498	0.501	0.99:1	CP 0+06.00 L 1.000
6	Left	Cut	1.00:1	N/A	5002	100.14	100.18	0.017	0.521	0.501	1.52	0.501	1.04:1	CP 0+06.00 L 1.000
6	Left	Cut	1.00:1	1	5003	101.53	100.14	0.017	1.513	0.501	2.513	0.501	1.04:1	REF CP 0+06.00 L 2.000
6	Left	Cut	1.00:1	N/A	5004	100.14	100.14	-0.002	0.498	0.501	1.498	0.501	0.99:1	CP 0+06.00 L 1.000
6	Left	Cut	1.00:1	1	82	102.28	100.14	-0.002	1.39	0.501	2.387	0.501	0.99:1	REF CP 0+06.00 L 2.000

Point and Offset Stake Format

This type of report will display the same records as the Point Stake and Offset Stake reports, but combine them into a single report.

Station	Offset	Offset Length	Design Pt	As Built Pt	Design N	Design E	Design EI	As Built EI	Cut(-)/Fill(+)	Delta N	Delta E	Design Desc	As Built Desc
			17	5005	5007.202	5003.499	100.202	100.2018	0	0	0	GRD	Design Pnt 17
			19	5006	5006.076	5001.161	100.119	100.1191	0	-0.007	0	GRD	Design Pnt 19
			20	5007	5008.335	4998.831	100.061	100.0615	0	-0.007	0	GRD	Design Pnt 20
1	Left	1.002		5008	5011.787	5004.505	100.166	100.1662	0	0.001	-0.001		0+01.00 L 1.000
			51	5009	5006.573	4992.566	99.815	99.8163	-0.001	-0.001	-0.001	GRD	Design Pnt 51
			51	5010	5006.573	4992.566	99.815	99.8163	-0.001	-0.001	-0.001	GRD	Design Pnt 51
			30	5011	4997.663	4996.693	99.815	100.2405	-0.425	-6.249	14.371	E/ASPH	Design Pnt 30
			31	5012	4996.107	4991.625	99.502	100.2405	-0.739	-7.805	9.302	E/ASPH	Design Pnt 31
2	Left	0.984		5014	5011.047	5003.832	100.062	100.0624	0	-0.018	0.005		0+02.00 L 1.000
2	Center	0.001		5015	5011.719	5003.092	100.062	100.0629	-0.001	-0.001	0		0+02.00 C 0.000
2	Right	1.005		5016	5012.391	5002.352	100.062	100.0622	0	-0.006	0.001		0+02.00 R 1.000
3	Left	1.001		5017	5010.306	5003.16	99.957	99.9643	-0.007	0	-0.001		0+03.00 L 1.000
3	Right	0.006		5018	5010.978	5002.42	99.957	99.9715	-0.014	-0.007	0.002		0+03.00 C 0.000
3	Right	1.002		5019	5011.651	5001.68	99.957	99.9619	-0.005	-0.004	-0.001		0+03.00 R 1.000

Productivity Report

This type of report will display how many points were staked out in one day. Each day will be separated into its own column so users can track the daily productivity of the field crew.

Reference Line Report

This type of report will display horizontal and vertical offset information with regards to the design and as-built point locations with regards to the referenced line used and the offset distance to the alignment.

Stored Station	Design Station	Stored Alignment Offset	Design Alignment	Stored Ref Line Offset	Design Ref Line Offset (H)	Stored Ref Line Offset (V)	Design Ref Line
28+643.99	30+044.80	3.00'	3.00'	3.34'	0.30'	-0.34'	0.00'
28+659.96	30+052.80	6.00'	3.00'	10.00'	10.00'	-0.35'	0.00'
28+680.00	30+058.80	6.00'	3.00'	4.99'	3.90'	3.00'	0.00'
28+682.99	30+064.80	7.00'	7.00'	3.36'	0.30'	-0.39'	0.00'
28+649.99	30+058.80	7.00'	7.00'	3.34'	0.30'	-0.35'	0.00'
28+660.00	30+062.80	7.00'	7.00'	-0.31'	0.30'	3.00'	0.00'
28+669.94	30+078.80	7.00'	7.00'	3.37'	0.30'	3.31'	0.00'
28+675.96	30+088.80	7.00'	7.00'	3.35'	0.30'	-0.34'	0.00'
28+685.90	30+098.80	7.00'	7.00'	3.35'	0.30'	3.37'	0.00'
28+695.91	30+108.80	7.00'	7.00'	3.35'	0.30'	-0.34'	0.00'

GIS Files

Shapefile Import

[Main Menu](#) | [Import / Export](#) | [GIS Files](#) | [Shapefile Import](#)

Imports a Shapefile and allows you to pick one attribute to associate with the shape.

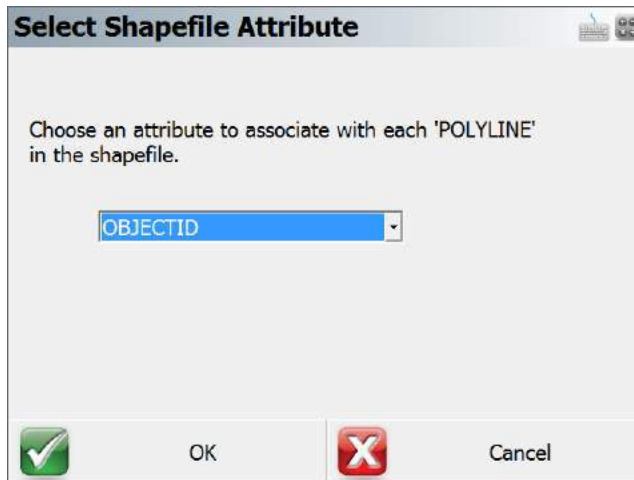

Shapefile Export

[Main Menu](#) | [Import / Export](#) | [GIS Files](#) | [Shapefile Export](#)

Use this to export your points and linework in a shape file format. This can then be imported into products that support shape files. This export will create a DBF, SHP and a SHX file for the linework and points in your Project.

For example, if your Project name was FG Sample, the following files will be created for the linework.

FG Sample_POLYLINE.shx

FG Sample_POLYLINE.shp

FG Sample_POLYLINE.dbf

For the points in your Project, FieldGenius already stores points in a DBF file (FG Sample.dbf) so only two other files will be created.

FG Sample.shx

FG Sample.shp

Importing into ESRI or other application

To open these files in a compatible product you need to ensure you have all six files saved in the same directory.

For more information on shape files, visit www.esri.com

KML Export

[Main Menu](#) | [Import / Export](#) | [GIS Files](#) | [KML Export](#)

Exports a KML file of all the points measured with GNSS.

Coordinate Systems

Import / Export User Defined Coordinate Systems

[Main Menu](#) | [Import / Export](#) | [Coordinate Systems](#) | [User Coordinate System Import](#)

[Main Menu](#) | [Import / Export](#) | [Coordinate Systems](#) | [User Coordinate System Export](#)

User defined coordinate systems created by a user are saved in the binary mapping system files.

It is useful to be able to export these user created coordinate systems for the following reasons:

1. A backup of your user defined coordinate systems.
2. Allows you to share user defined coordinate systems with other crews.
3. Allows you to load user defined coordinate systems after installing a FieldGenius update.

Import

You can import coordinate systems from a previously saved file.

When you import a file you will be asked to browse to and select the file you want to import. Once selected, FieldGenius will check to make sure a user defined system doesn't already exist and if one does, you will be asked if you want to skip importing it, or overwrite the existing coordinate system.

Export

When you export the user defined coordinate systems you will be able to specify a directory to save the file to and a name for the file.

Exported files will automatically be saved with a CSMAP extension such as **mycoordinatesystem.csmap**.

All user defined coordinate systems in FieldGenius will be exported to the file.

Backups

FieldGenius automatically creates a backup when you add or edit user defined coordinate systems. If you forgot to save your user defined coordinate systems, you may be able to restore them using a backup. Please see the [Coordinate System](#) topic for more details.

Data Manager Menu

Main Menu | Data Manager

This menu allows you to organize, manipulate and view the different data types that may be associated with your FieldGenius Projects.

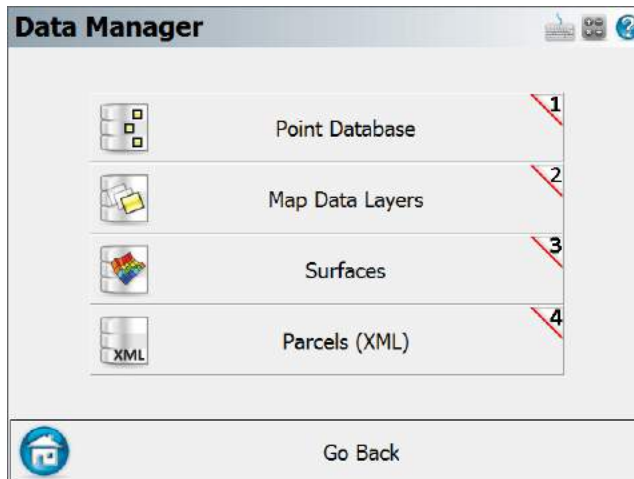

Points Database

Use this to open the points database. From here you will find numerous tools that can be used to edit your points. Please see the [Coordinate Database](#) topic for more information.

Map Data Layers

Use this to import DXF, LandXML, and georeferenced raster image files into your Project, and to control the visibility of database layers and any files that you may have associated with your Project. Please see the [Map Data Layers](#) topic for more information.

Surfaces

Use this to import DTM surface files into your Project, view and edit your DTM surfaces, and perform volume calculations. Please see the [Surfaces](#) topic for more information.

Parcels (XML)

Use this to edit and view your XML parcels that are associated with your Project. Please see the [Parcels \(XML\)](#) topic for more information.

Point Database

[Main Menu](#) | [Data Manager](#) | [Point Database](#)

The point database dialog is used to review, edit, and manipulate your point data in your Project database. The list will display all points currently stored in the database, and the data can be sorted by pressing the column headers.

Point ID		Northing	Easting	Elevation
1		5523958.627m	312330.376m	393.413m
2		5523853.287m	312321.092m	392.877m
3		5523853.567m	312320.797m	392.747m
4		5523947.627m	312330.376m	391.413m
5		5523882.649m	312304.231m	394.168m
6		5523851.309m	312319.695m	393.413m
7		5523869.731m	312330.376m	393.678m

Point ID (Survey Role) Icons



The instrument icon indicates your current occupied point.



The target icon indicates your current backsight point.



The stake icon indicates points that are to be staked out.



The checked stake icon indicates points that have been staked out.



The hub icon indicates control points, they cannot be edited under any circumstances.



The user icon indicates user entered points, the coordinate can be edited.



The ruler icon indicates measured points, the coordinate cannot be edited.



The 123 icon indicates calculated points, the coordinate cannot be edited.



The stake and square icon indicates a Staked and Stored point. The Staked and Stored survey role is unique and not associated with LandXML schema.

Note:

To edit the coordinate of a measured or calculated point, you must first change its survey role to **user entered**.

Next/Previous

Use the green arrow button to display the next button sets for more options.

Edit

Use this to edit the coordinates of a point that is highlighted in the list using the [Store/Edit Points](#) tool. Remember you must change the Survey Role to **User Entered**.

Delete

Use this to delete the current point or selection in the list. Note: There is no undelete point option in FieldGenius. If you delete points from the coordinate database they cannot be restored without editing and reprocessing your raw file.

Add

Use this to open the [Store Point](#) screen to manually enter a new point.

Find

Use this to select multiple points, based on a single point ID, a point ID range, a point coordinate range, or point descriptions.

RTS (Rotate/Translate/Scale)

Use this to rotate or translate your points that are currently selected in the coordinate list. When you press the button you will see the Rotate / Translate / Scale Points screen. Please refer to the [Rotate / Translate / Scale](#) topic for more information.

Local Transform

Use this to apply a coordinate transformation to a point or selection in the coordinate list. You need to have calculated the transformation parameters prior to pressing this button. See the

Statistics

Use this to display statistics of the coordinate database, including the total number of points, bounding minimum and maximum coordinate values, and point ID's in use, and point ID's not in use.

Map View

Use this to display the currently highlighted points on the screen.

Average

Press this button to enter the [Point Averaging](#) routine.

Map Data Layers

[Main Menu](#) | [Data Manager](#) | [Map Data Layers](#)

Use this to load, unload, and control the visibility of DXF files, LandXML files, and JPG or TIFF raster image files that are associated with your Project, and to control the visibility of your database layers.

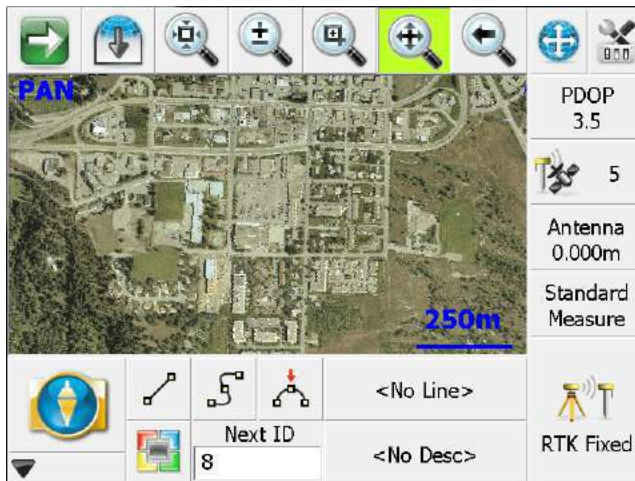
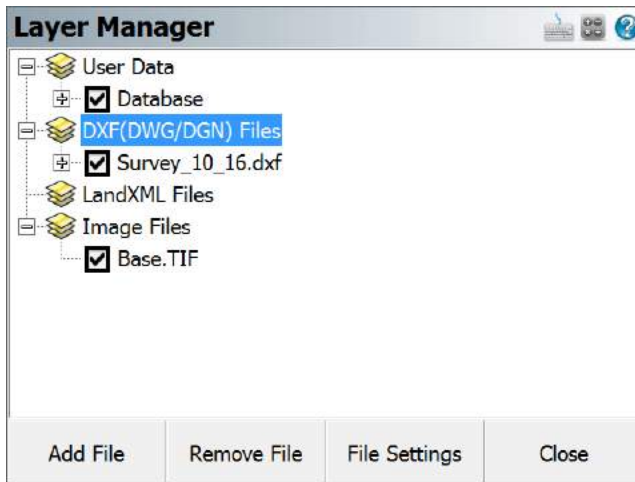

User Data

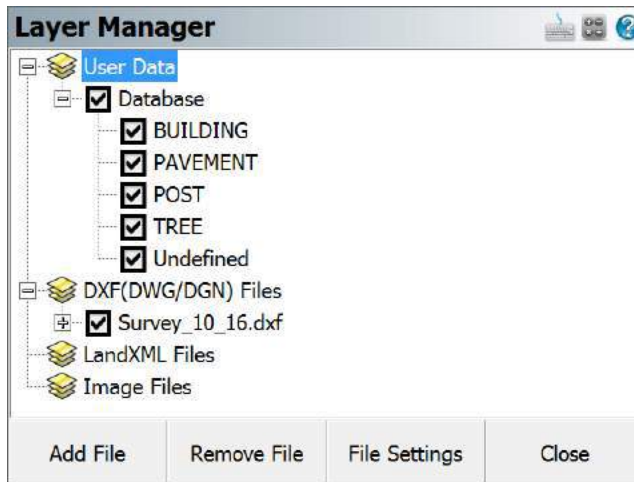

FieldGenius uses the layer names specified in the AutoMap library to control the visibility of points and figures by their description.

You can control the visibility of the entire database (both points and figures) by checking or unchecking the Database option under the User Data section of the tree. If the box is checked, then the database is turned on and all of its layers will be visible; if unchecked, then the file and all of its layers is turned off and it will not be visible. If the box has another smaller square inside it, this means that some of its layers are turned on and other layers are turned off.

You can control the visibility of individual layers by expanding Database option under the User Data section of the tree, and checking or unchecking the box beside the name of the layer. If the box is checked, then the layer is turned on and entities on that layer will be visible; if unchecked, then the layer is turned off and entities on it will not be visible.

When you close the Project, the layer status will be saved so that the next time the Project is opened, the layer visibility will automatically be set the same as you had left it, so layers that were turned off will remain turned off the next time the Project is opened up.

DXF Files



You can load multiple DXF files into your FieldGenius Project, and control the visibility of each of their layers independently from the others.

You can control the visibility of the entire DXF file by checking or unchecking the box beside the name of the DXF file, under the DXF Files section of the tree. If the box is checked, then the file is turned on and all of its layers will be visible; if unchecked, then the file and all of its layers is turned off and it will not be visible. If the box has another smaller square inside it, this means that some of its layers are turned on and other layers are turned off.

You can control the visibility of individual layers by expanding the name of the DXF file under the DXF Files section of the tree, and checking or unchecking the box beside the name of the layer. If the box is checked, then the layer is turned on and entities on that layer will be visible; if unchecked, then the layer is turned off and entities on it will not be visible.

When you close the Project, the layer status will be saved so that the next time the Project is opened, the layer visibility will automatically be set the same as you had left it, so files that were turned off will remain turned off the next time the Project is opened up.

Add File

Press the Add File button to select a DXF file that you want to load into your Project. You will be able to browse to and select any DXF file. Please see the [Import DXF File](#) topic for more information.

Remove File

Highlight the DXF file that you want to remove from your Project, then press the Remove File button. If a file is not highlighted, you will be reminded that a file must first be selected from the tree. This will turn off all layers from the selected file in your FieldGenius Project and disassociate the DXF file. It does not delete the DXF file.

File Settings

Highlight the DXF file that you wish to change the settings for, then press the File Settings button. You can enable or disable the display of text in the selected file. If your DXF file contains text, turning this off will improve performance of FieldGenius. Pressing the OK or Cancel buttons will return you to the Layer Manager screen.

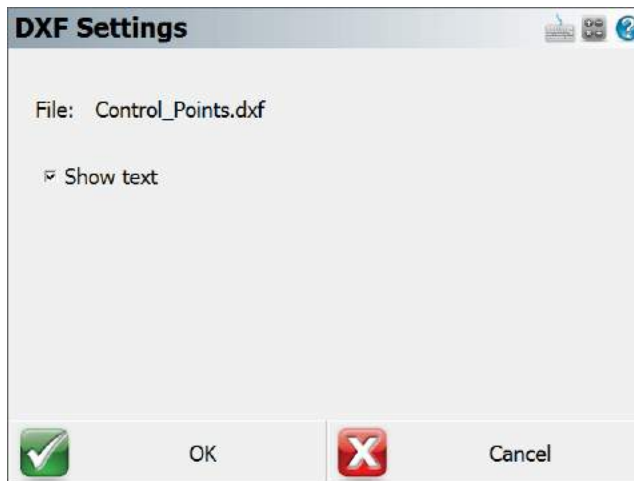

LandXML Files

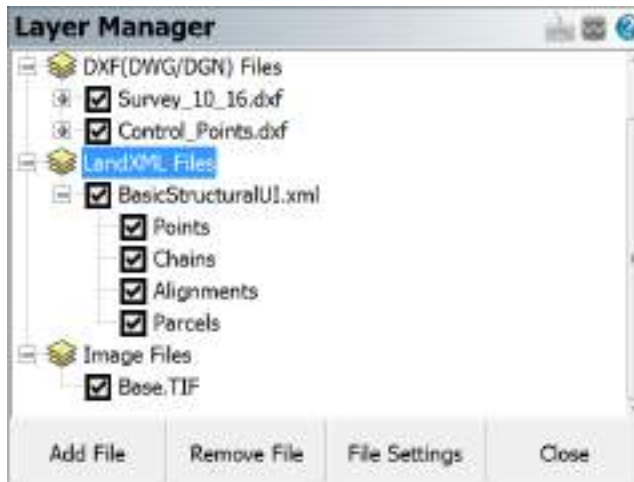

You can load one LandXML file into your FieldGenius Project at a time, and control the visibility of its layers (points, chains, alignments, and parcels).

You can control the visibility of the entire XML file by checking or unchecking the name of the XML file, under the LXML Files section of the tree. If the box is checked, then the file is turned on and all of its contents will be visible; if unchecked, then the file and all of its layers is turned off and it will not be visible. If the box has another smaller square inside it, this means that some of its layers are turned on and other layers are turned off.

You can control the visibility of individual layers by expanding the name of the XML file under the LXML Files section of the tree, and checking or unchecking the box beside the name of the layer. If the box is checked, then the layer is turned on and entities on that layer will be visible; if unchecked, then the layer is turned off and entities on it will not be visible.

When you close the Project, the layer status will be saved so that the next time the Project is opened, the layer visibility will automatically be set the same as you had left it, so layers that were turned off will remain turned off the next time the Project is opened up.

Add File

Press the Add File button to select a LandXML file that you want to load into your Project. You will be able to browse to and select any XML file. Please see the [Import LandXML File](#) topic for more information. Note, you must first unload the currently loaded XML file before loading a different one.

Remove File

Highlight the XML file that you want to remove from your Project, then press the Remove File button. If a file is not highlighted, you will be reminded that a file must first be selected from the tree. This will turn off all components of the selected file in your FieldGenius Project and disassociate the XML file. It does not delete the XML file.

File Settings

The File Settings button does not apply to LandXML files.

Image Files

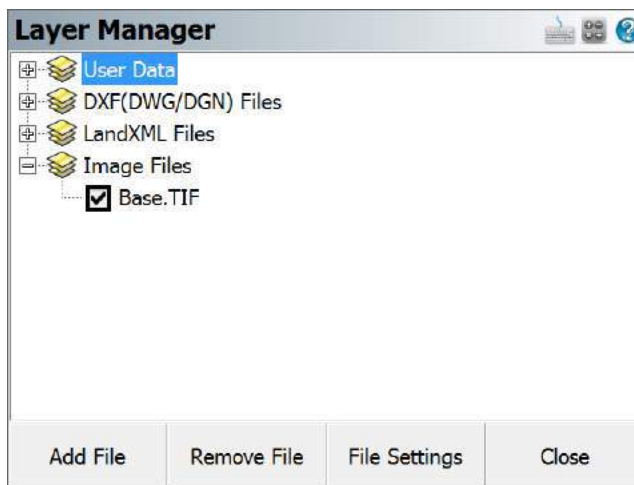

You can load georeferenced JPG or TIFF images into your FieldGenius Project, and control the visibility of the image.

You can control the visibility of your image by checking or unchecking the box beside the name of the image file, under the Image Files section of the tree. If the box is checked, then the image is turned on and it will be visible; if unchecked, then the image is turned off and it will not be visible.

When you close the Project, the visibility and opacity status of the image file will be saved so that the next time the Project is opened, the image visibility will automatically be set the same as you had left it.

Add File

Press the Add File button to select an image file to load into your Project. You will be able to browse to and select any JPG or TIF file. JPG files must have a corresponding JGW world file, and TIF files must have a corresponding TFW world file; these world files contain the georeferenced positioning information. The world file must have the same file name as the image file (just with the appropriate extension), and it will be automatically used to position the image. Note that the world file is unit-less, make sure that the unit settings in the desktop and mobile software are the same.

Remove File

Highlight the image file you want to remove from your Project, then press the Remove File button. If a file is not highlighted, you will be reminded that a file must first be selected from the tree. This will turn off the selected image in your FieldGenius Project and disassociate the image file.

File Settings

Highlight the image file you want to view or change the display settings for, then press the File Settings button. You will see the file's name, size, and position information. You can also adjust the opacity of the image. The default value of 100 will cause the image to be displayed normally, and reducing this value will make it appear fainter on the screen. This is useful if the image file being displayed makes your other FieldGenius data too hard to see over top of the image. Pressing the Close button will return you to the Layer Manager screen.

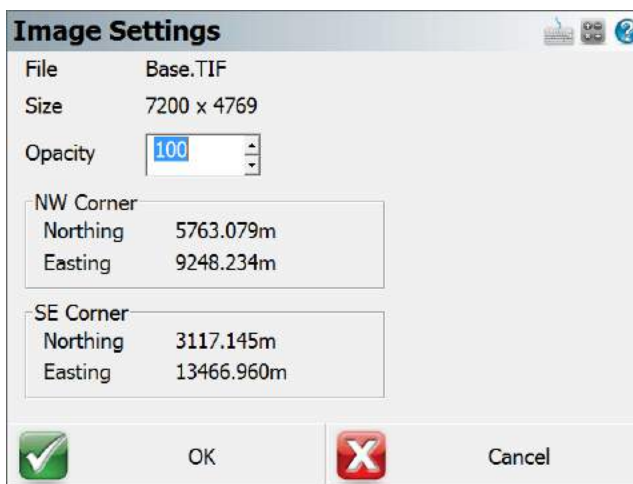

Surfaces

[Main Menu](#) | [Data Manager](#) | [Surfaces](#)

[View Toolbar](#) | [Surface Manager](#)

FieldGenius allows you to display a 3D surface representation of the points and lines in your project. This is done by turning on the Point Database surface.

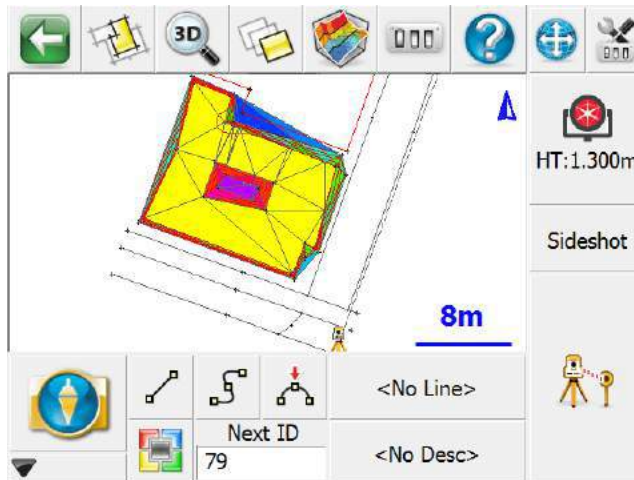

Supported DTM Files

You can import surface information into FieldGenius. Currently you can import a surface from an XML or QSB file.

LandXML Surface

FieldGenius can import surface definitions from XML data sets. These surfaces can be used to display a TIN, shaded surface or contours on the screen. The surface can also be used to perform real-time DTM staking.

To import a LandXML file, go to Map Data Layers and use the **Add File** command. Please see the [LandXML Import](#) topic for more information.

QSB Surface

Surfaces created and saved in MicroSurvey CAD or inCAD desktop products will have a QSB extension. These QSB files can be imported into FieldGenius and used to display a TIN, shaded surface or contours on the screen. The surface can also be used to perform real-time DTM staking.

To import a QSB file, use the Load button at the bottom of the Surface Manager screen. Please see the [DTM Surface File Import \(QSB\)](#) topic for more information.

DTM Surface Manager

The surface called Point Database represents the real-time DTM Surface made up from points and lines that are in your project. If you have imported any other surfaces from a QSB or LandXML file they will also appear in this list.

To use a surface you first need to load it into memory by checking inside the box before the name of the surface in the list. A surface is loaded if there is a checkmark shown before it. If you expand the surface you can control whether it is drawn as Contour Lines, a wireframe TIN, a solid TIN, or any combination of these.

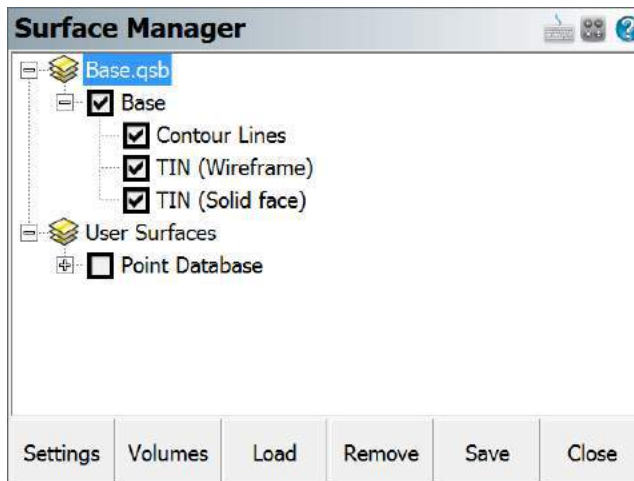

Settings

Surface settings allow you to specify settings that affect the surfaces or contours that are drawn. Please see the [Surface Settings](#) topic for more information.

Volumes

Use this button to calculate a volume. Please see the [Volume Calculation](#) topic for more information.

Load

Use this button to load a .QSB surface file into your project. Please see the [Import DTM Surface File](#) topic for more information.

Save

Use this button to save the selected surface as a .QSB file which can be imported into your MicroSurvey CAD or inCAD desktop software or into another FieldGenius project.

Close

If you close the surfaces screen and return back to the map screen you will see the loaded surface drawn as a wireframe, solid, and/or with contours depending on what is set in the Settings screen.

Surface Information

You can see additional statistics about the surface by double clicking on its name in the list. This will show the minimum and maximum bounding coordinates, the number of points, breaklines, and triangles in the surface, the minimum and maximum slopes in the surface, the plan and surface area, the positive and negative volumes calculated from a datum elevation of 0, and the amount of memory that the surface is using.

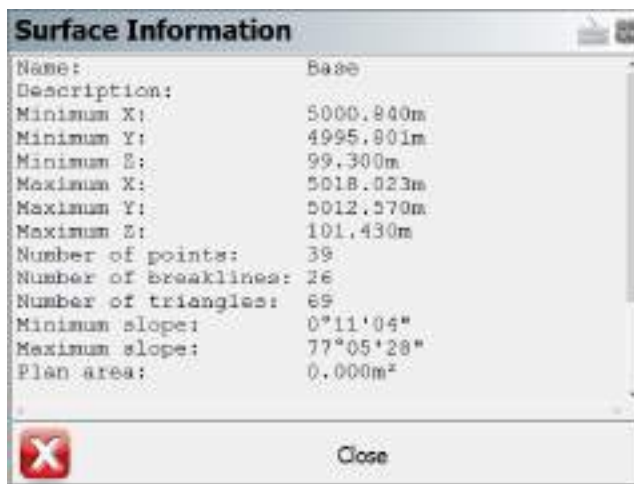

Point Database Surface

This can be used at any time and doesn't require a surface to be imported. When this is turned on, all the points and lines in your project will be used to create a real-time DTM surface. This can be used while you're taking shots.

Please refer the [Real-time DTM Surface](#) topic for more information on FieldGenius DTM surfaces.

Surface Settings

[Main Menu](#) | [Data Manager](#) | [Surfaces](#) | [Settings](#)

[View Toolbar](#) | [Surface Manager](#) | [Settings](#)

Use the surface settings screen to define settings that affect TIN (Triangular Irregular Network), TGRID and Contours.

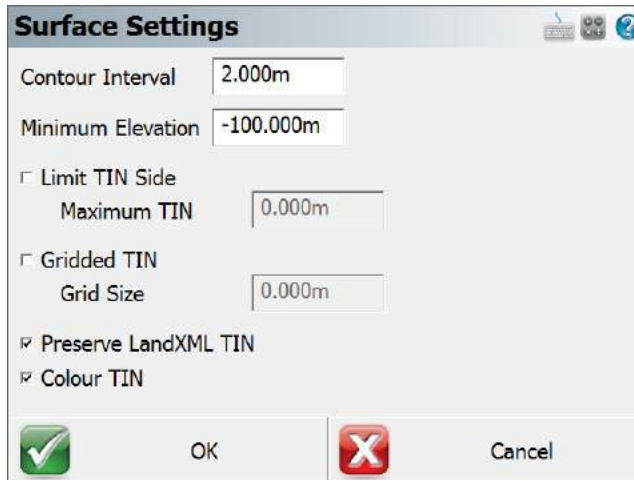

Surface Settings

Contour Interval: 2.000m

Minimum Elevation: -100.000m

Limit TIN Side
Maximum TIN: 0.000m

Gridded TIN
Grid Size: 0.000m

Preserve LandXML TIN

Colour TIN

OK Cancel

Contour Interval

This will force the contours to be drawn at an interval equal to the value set here. The interval is equal to the drawing units.

Minimum Elevation

This controls the minimum elevation. This is useful if you have some data that is displayed at a zero elevation (example: alignment point data that is horizontal) and you want to exclude these points from the surface.

Limit TIN Side

This will determine the max length that will be allowed for a TIN triangle.

Gridded TIN

If this is on, when you draw the surface it will be represented using a TGRID model instead of a TIN model. TGRID surfaces will apply smoothing in areas that have no breaklines. This may create better quality contours. The Grid Size is a ground unit value that will determine the spacing of the grid lines. If the Grid Size is 0 then a grid size will be automatically calculated.

Preserve LandXML TIN

This will force the surface to be loaded using information stored in the LandXML file. A LandXML surface will be defined in such a way that each triangle corner is defined by a point id. These points are stored in the file as CgPoints, so FieldGenius will honor these faces and not re-compute a new surface.

Color TIN

When this is turned on then the surface color will be determined by the triangles' elevation. When turned off the surface will be displayed using a gray color. If the TIN's wireframe and solid faces are both being displayed, then the faces will be colored but the wireframe will be gray for better visibility.

Volume Calculation

[Main Menu](#) | [Data Manager](#) | [Surfaces](#) | [Volumes](#)

[View Toolbar](#) | [Surface Manager](#) | [Volumes](#)

FieldGenius allows you to calculate the volume between a surface and either another surface or a datum elevation. The volume can be computed for the entire surface, or it can be bound by a closed figure.

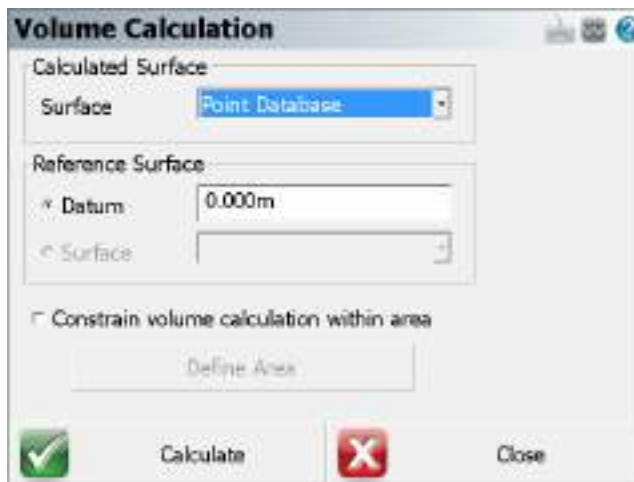

Calculated Surface

Choose the surface that you want to calculate the volumes for. If you have imported any surfaces from a QSB or LandXML file they will be available to choose from, or you can choose the real-time Point Database surface.

Reference Surface

You can choose have the volume calculated between your selected surface and either a datum elevation (which defaults at 0 meters/feet), or if you have imported any surfaces from a QSB or LandXML file they will be available to choose as a reference surface.

Constrain volume calculation within area

If this is unchecked, a surface volume calculation will be computed for the entire surface. If this is checked, an area volume calculation will be computed for a portion of the surface bounded by an area you define. You can press the **Define Area** button to select a closed figure to assign as a boundary for the volume calculation. After you have selected the figure, press Close to return to the Volumes Calculation screen.

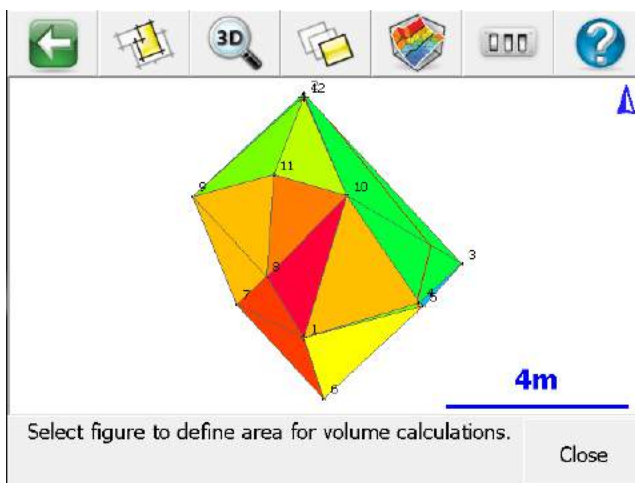

Calculate

Pressing this will calculate and display the positive, negative and net volumes, the average thickness, and the area of the surface from either the selected datum elevation or reference surface, all constrained within the selected closed figure if selected.

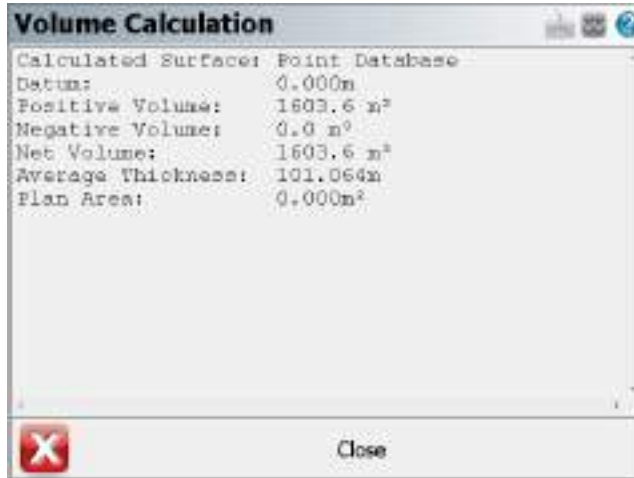

The results will also be written into the project's CogoCalcs.txt history file which can be viewed by going to Main Menu | Survey Tools | [COGO History Viewer](#).

Real-time DTM Surface

FieldGenius creates and manipulates a 3D surface from data collected in the field or from data imported through LandXML, QSB or ASCII point files. A FieldGenius surface is a mathematical description of a surface that exactly honors all input 3D data points and lines.

A Surface represents the existing topography of a job site. Surfaces contain one or more parts such as points, breaklines, triangulated irregular networks (TIN), or triangulated grids (TGRID).

A surface is not a drawing entity, rather it is a mathematical description held in the data collectors memory. Representations of a surface, such as contours, TGRIDS or TINS may be drawn into your diagram as polylines and polyface entities.

Creating a Real-time DTM in FieldGenius

FieldGenius will compute a DTM model from points collected, staked, or imported from any ASCII file and from any existing FieldGenius project. There are no limits to the number of points that are used to create the DTM. The AutoMap Library controls what points and/ or lines are included or excluded from the DTM surface. The DTM is created in real time and can be appended as additional points are picked up.

To create a DTM, follow the instructions below:

From Main Menu | Data Manager | Surfaces you can turn on the **Realtime DTM Surface** by placing a checkmark in the box before the "Point Database" surface. Expanding the tree will allow you to define whether it is displayed as Contour Lines, Solid Faces, and/or Triangle Edges.

The surface can be viewed or used in volume computations immediately.

Before turning on the Point Database surface:

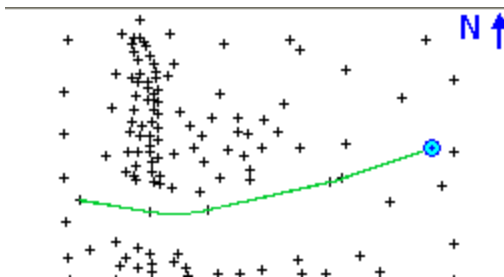

After turning on the Point Database surface:

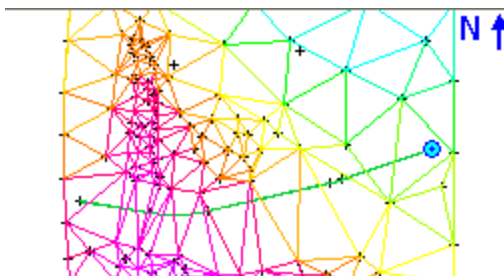

Each point in the database has an attribute called "DTM State". This can be set to "Do not Include". If you set a point to this value, you will see that the surface no longer includes this point. This only applies to the current surface that is computed in FieldGenius. It does not apply to surfaces imported from a QSB or LandXML file.

What is the difference between a TIN and a TGRID?

The user should become familiar with both options and decide which option is best suited for their project.

TIN honors breaklines but may be too restrictive for contours to follow the natural flow of the terrain. Contours around small hills may look jagged if too few data points were collected.

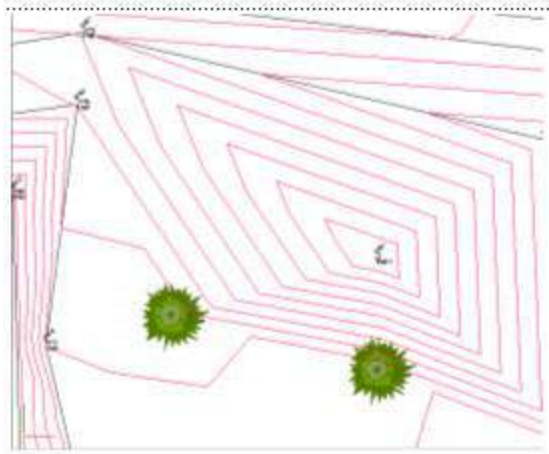

TGRD honors breaklines and allows the contours to follow the natural flow of the terrain. Contours around small hills will look better if the TGRD option is used.

Generally, the **TGRD** is for cases where you want curvature introduced between your data points and you have breaklines. This is most easily shown with an example:

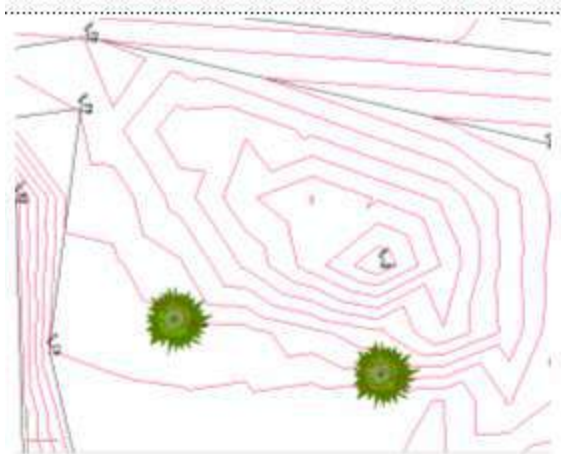

Adding Breaklines to a Surface

If a break in the slope continuity is desired, the user **MUST ALWAYS** use the TIN or TGRD (Tri-angulated Grid) in conjunction with breaklines. When modeling a surface containing breaklines, a TIN or TGRD honors breaklines exactly.

What happens when you add breaklines?

Breaklines represent 3D continuous traces in space (think of them as a 3D polyline) which:

1. Define the surface elevation
2. Force slopes to be different on either side of the breakline



This line represents a location at the site where the slope changes from a steep hill to a relatively flat area.

Contours Generated without use of Top of Bank breakline:

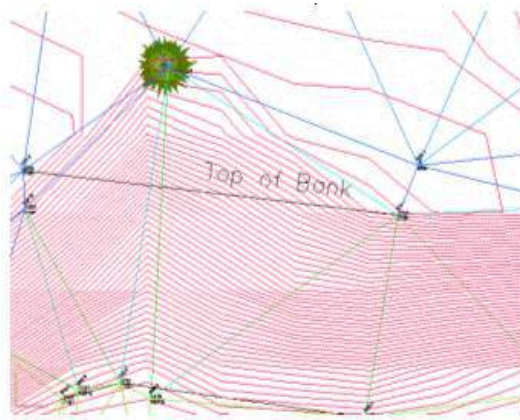

Without a breakline, the contours "flow" over the top of the bank and the contours do not look correct. Contours generated with use of Top of Bank breakline:

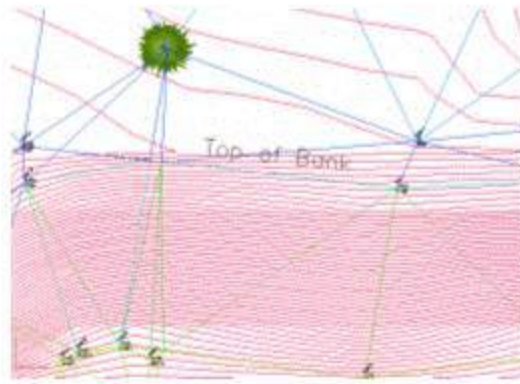

With a breakline, the contours are forced to honor the line, as a change in slope that helps the contours to look correct.

Breakline Control

The user would want to use a figure as a breakline in the triangle formation process (TIN) for the edge of pavement, but probably not for a line connecting points that are not related to the surface features. An example of this might be a chain connecting legal boundaries as they might cross over roads or creeks without consideration for the existing topography.

Breaklines are used in the creation of the DTM by forcing the triangulation to follow them. Triangles created in the DTM cannot cross a breakline. The edges of the triangles will always follow the breakline. When necessary, FieldGenius will automatically densify the DTM along the breakline to create triangles that conform to the breaklines. This helps with the creation of accurate surface models and contours. FieldGenius contains the exact same functions for surface modeling, contouring, and volumes as MicroSurvey CAD or inCAD.

Contouring

Creating contours in FieldGenius is as simple as choosing the desired DTM surface from the dialog and checking the contour option:

The procedures for contouring a DTM surface are outlined below:

1. Open the [Surface Settings](#) dialog.
2. Type in the appropriate **Contour Interval**. The default interval is every 2 units.
3. You can control the **Minimum Elevation**. This is useful if you have some data that is displayed at a zero elevation (example: alignment point data that is horizontal) and you want to exclude these points.
4. If you want to create a TGRID, then turn on the Gridded TIN option, or leave this off to create a TIN. The Grid Size is a ground unit value that will determine the spacing of the grid lines.
5. Press **OK** to return to the [Surface Manager](#) screen.
6. Finally, turn on the contours by expanding the Point Database surface and selecting the Contour Lines option to display them.
7. Close the Surface Manager and return to the map screen to see your contours.

Import DTM Surface File (QSB)

[Main Menu](#) | [Data Manager](#) | [Surfaces](#) | [Load](#)

[View Toolbar](#) | [Surface Manager](#) | [Settings](#)

If you have a DTM surface that was created by MicroSurvey CAD or inCAD desktop software, you can import it into FieldGenius. You need to copy the QSB file to your collector before proceeding.

Function

1. Open the [Surface Manager](#), then press the **Load** button.
2. Browse to where your DTM surface file (.QSB) is located and press the **Open** button to continue.
3. You will now see the surface list screen. From here you can turn on your layer and configure DTM settings. Please see the [Surface Sets](#) topic for more information.

Parcels Manager (XML)

[Main Menu](#) | [Data Manager](#) | [Parcels \(XML\)](#)

When a LandXML file is imported into a FieldGenius project, if there is parcel information it can be viewed in the Parcels Manager.

By default all Parcels will be visible in the map screen but you can turn them off by deselecting the green check mark next to the parcel group.

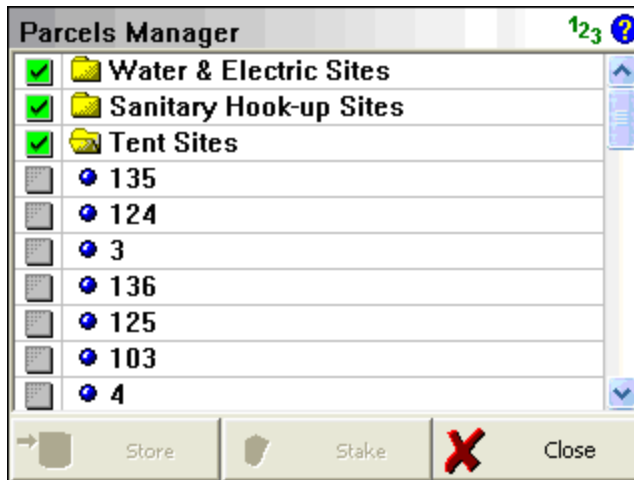

Store

If you highlight a parcel in the list, pressing the Store button will compute and store coordinates at the corners of your parcel.

Stake

If you press this it will open the line staking toolbar. Note: you have to press close to exit the parcel manager.

Roads Manager

Main Menu | Roads Manager

To stake an alignment you first need to define the geometry that defines the horizontal and vertical element. You can also define a template that will be used to define cross sections at specific stations along the alignment.

FieldGenius can use the following three methods to define an alignment.

1. Manual Entry – You can manually enter the data to define the alignment.
2. Import XML – You can import a LandXML file that contains your alignment data.

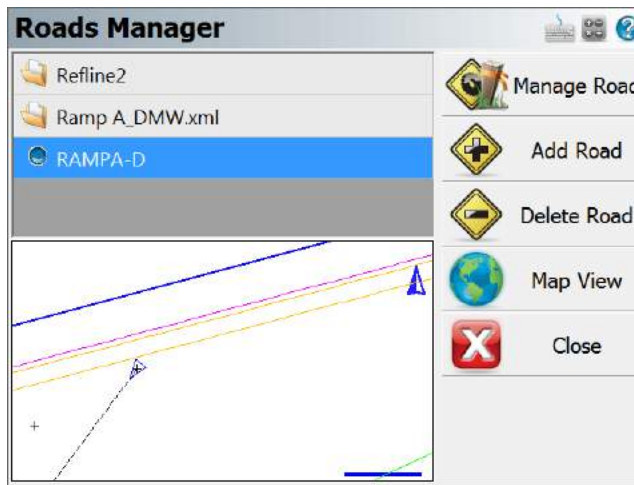

By default you will see an alignment in the list with the current project name. A project can contain multiple roads, and each road can contain the following elements.

- **Horizontal Element:** This can contain straight tangents, curves and spirals.
- **Vertical Element:** This can contain grade breaks, parabolic curves and non-symmetrical curves.
- **Templates:** Template can contain horizontal and vertical offsets, as well as widening and super elevation data.
- **XML Cross Sections:** XML cross sections define specific stations along an alignment. These sections contain horizontal, vertical and template data. XML cross sections are created using desktop software which is then imported into FieldGenius.

Manage Road

This option is only available once you've created a road using the New Road button or imported an XML file. To input or review alignment data, press the Manage Road button to access the Road Settings screen.

If you imported a LandXML file, or manually inputted a road you can stake it by pressing this button. As a minimum you need to have the following before the stake command will continue.

- XML Cross sections
- Horizontal C/L, Vertical Profile and template.
- Horizontal C/L and DTM Surface

Add Road

Use this button to create a new road. You can create as many roads as needed and they will be stored in an XML file that will reside in the project directory.

Delete Road

Use this to delete a road. You first need to highlight the road you want to delete, and then press the button to remove the road from the alignment. This road will be permanently deleted and cannot be undone.

Map View

Use this button to display the map view. From this view you can use the zoom controls to zoom around your drawing so you can find important or relevant data for your alignment such as a POB point. Press the Close View button to return back to the Roads Manager.

Tell me more about ...

[Road Settings](#)

[Manual Entry - Alignment C/L](#)

[Manual Entry - Vertical Profile](#)

[Manual Entry - Template](#)

[LandXML Cross Sections](#)

[Alignment DTM Surface](#)

[Alignment Staking - Part 1](#)

[Alignment Staking - Part 2](#)

[Alignment Slope Staking](#)

Manage Road

The road settings screen is used to help you create, review or modify road elements.

The screenshot shows a dialog box titled "Road: RAMPA-D". It contains several input fields and dropdown menus:

- Start Station: 20+000.00
- Alignment C/L: 1100.00'
- Vertical Profile: (empty dropdown)
- Template: (empty dropdown)
- Cross-Sections: (empty dropdown)
- DTM Surface: (empty dropdown)
- <Select Reference Line>: (empty dropdown)

At the bottom, there are four buttons: "OK" (with a green checkmark icon), "Stake Road" (with a surveying stake icon), "Cancel" (with a red X icon), and a small icon of a surveying instrument.

From this screen you can do any of the following:

- Define start station
- Define start point or start coordinates
- Define the [horizontal element](#)
- Define the [vertical profile](#)
- Choose either a [template](#) or [XML cross sections](#)
- Choose an optional [DTM surface](#)
- Select a DXF Reference Line

Define Start Station

Each road has to have a starting station defined. The starting station will place the station sign automatically for you after you enter the station. Stations generally are measured in 100 foot intervals when working in feet, and measured in 1000 metre intervals when in metric projects.

There are three station format settings that you can choose from: 0+000.000, 0+00.00, or 0.000. You can change this by going to the Main Menu | Settings | [Options](#) or by pressing the **Alignment C/L** button and selecting **Settings**.

Note: Positive or negative start stations are valid.

Define Start Point or Coordinates

Every road that you create needs to have a starting location defined. You have two options available to define this location.

Start ID

If you have a point stored in your project's database that is also the start point for the alignment, you can use this point as the start location. Simply enter the point number in the **Start Pnt** field, or use the point chooser to select it from the map. Once you've selected the point, the point's Northing and Easting values will be displayed. At this point, the elevation is not needed because the profile is what defines the elevations along the road.

When you use the point chooser or enter a point id, all that will happen is the coordinates for the point are written to the alignment file. The next time you open the alignment file, you will no longer see the point ID that was used, you will only see the coordinate values.

Enter Coordinates

If you don't have a point that defines the start location, you can define it by entering a Northing and Easting value. You have to leave Start ID field blank if you want to enter coordinates.

Manual Entry - Alignment C/L

[Main Menu](#) | [Roads Manager](#) | [Edit Road](#) | [Alignment C/L](#)

To define the centerline data press the **Alignment C/L** button which will open a menu. On this menu select **Edit** to open the C/L Editor.

If you're entering a new road the C/L Editor will not have any elements listed. In the example shown below there are three elements defined; 2 tangents and 1 curve element. In the element list, it will always display the length of the element and its end station. Furthermore, all elements that are defined will be displayed in the Map so you can visually confirm that the geometry is correct.

Delete C/L Alignment

You cannot delete a C/L Alignment once it has been created.



The C/L Editor can display a view of the map along the bottom. This view can be toggled on and off by pressing the **Show Map/Hide Map** button.

If you would like to zoom into or pan around the map, press the **Map View** button which will display zoom and pan controls. Press the Close View button when you want to return the C/L Editor.

Adding an Element

To add an element to a road you need to use the **Add Element** button. Once you press this you will see 5 options appear that will help you define the different elements supported by FieldGenius.

- Line (Tangent)
- Curve
- Spiral
- Spiral-Curve-Spiral
- Chain

Tip: When you're prompted for a distance or direction, you can always use the [distance](#) and [direction](#) recall features just like you would for COGO calculations.

Line (Tangent) Element

In the Line Element editor, gray fields indicate fields that cannot be edited. All other non gray fields can be edited by the user. When you enter your known values and have confirmed their correctness, press OK to save these values, or press Cancel to exit without saving.

A tangent is defined by a direction and length. There are four ways you can define the tangent and they are explained in further detail below.

Line (Tangent) Editor	
Start Pt ID	
Start Northing	0.000m
Start Easting	0.000m
Direction	0°00'00"
Length	100.000m
End Northing	100.000m
End Easting	0.000m
End Station	0+100.000
 End Pt ID	
 OK	 Cancel

Direction and Length

If you know these two values, you can enter them in their respective fields. You will see that the end coordinates and end station will be computed automatically.

End Northing and End Easting

If you know the coordinates for the end of the tangent, you can enter them in the End Northing and End Easting fields. Once you've done this, the direction, length and end station fields will be updated automatically.

Direction and End Station

If you know the direction and end station of the tangent, enter these known values in their respective fields. Once you've done this, the length and end coordinate fields will be updated automatically.

End Point ID

If you have a point in the project database that defines the end of the tangent, you can enter the point number in the ID field, or use the point chooser to select it from the map. Once you've done this, the direction, length, end coordinates and end station fields will automatically be updated.

Curve Element

When you select this option you will see the curve editor with most of the fields being empty.

Curve Editor	
Radius - Arc Length	
Arc Direction	Right
Arc Length	50.000m
Arc Radius	25.000m
Arc Chord Length	42.074m
Arc Chord Bear	57°17'45"
Arc Delta Angle	114°35'30"
Deg of Curve (arc)	229°11'00"
Deg of Curve (chord)	
Tangent Length	38.935m

OK Cancel

Define Known Data

You first have to define what known information you want to use to compute the curve. If you click on the drop down list you will see a list of all the options that can be used to compute the unknown values.

Enter the Known Data

Once you define the known data format, you will see grayed out fields which indicate they can't be edited. White areas indicate fields that can be edited, and these fields will match what you defined in the first step.

1. You always have to define the direction for the curve, either right or left.
2. Enter your know values.
3. You don't have to specify the PC point, the function will assume that you're beginning at the end of the last leg.
4. A PC Tangent direction will automatically be computed based on the previous tangent. You can always over ride this value if you need to define a non-tangent curve.
5. Press **OK** to save your inputted values, **Cancel** to exit without saving.

Spiral Element

When you select this option your will see the spiral editor. This will help you define a spiral segment for your alignment.

Parameter	Value
Spiral Direction	Right
Radius Start	Infinite
Radius End	35.000m
Spiral Length	100.000m
Spiral Angle	81°51'04"
Starting Station	0+100.000
Starting Northing	100.000m
Starting Easting	0.000m
Starting Tangent	0°00'00"
Ending Station	0+200.000

Buttons: OK Cancel

Define Known Data

To solve for this type of element you need to know:



- Spiral Direction
- End Radius
- Spiral Length

In the editor, gray fields indicate fields that cannot be edited. All other non gray fields can be edited by the user.

Press **OK** to save your inputted values, **Cancel** to exit without saving.

Spiral – Curve – Spiral

Curve Direction	Left
Spiral In Length	22.000m
Spiral Out Length	35.000m
Curve Radius	50.000m
Curve Length	75.000m
TS Station	0+225.000
TS Northing	150.221m
TS Easting	109.310m
TS Tangent	114°35'30"
SC Station	0+247.000

Define Known Data

To solve for this type of element you need to know:

- Spiral Direction
- Spiral In Length
- Spiral Out Length
- Curve Radius
- Curve Length

In the editor, gray fields indicate fields that cannot be edited. All other non gray fields can be edited by the user.

Press **OK** to save your inputted values, **Cancel** to exit without saving.

Chain

Use this option if you want to select points or figures in your drawing to define the centerline and the profile (optional).

When you select the **Add Figure** option you will be taken to the map screen where you can select a figure.

You can also add points individually by using the **Add Points(s)** button.

Press **OK** to save the chain, press **Cancel** to exit without saving.

Note:

You should only select Tangent sections for a Chain. If you Add a Figure which contains arcs or splines, the chain will straight-line any curved segments, so the resulting Chain length and stationing will not be the same as the original Figure.

Chain Element

When you return to the road editor you will see that a chain element has been created. Chain elements differ from regular elements in that even though a chain can be made up of line and curve elements, it will appear in the list as a chain.

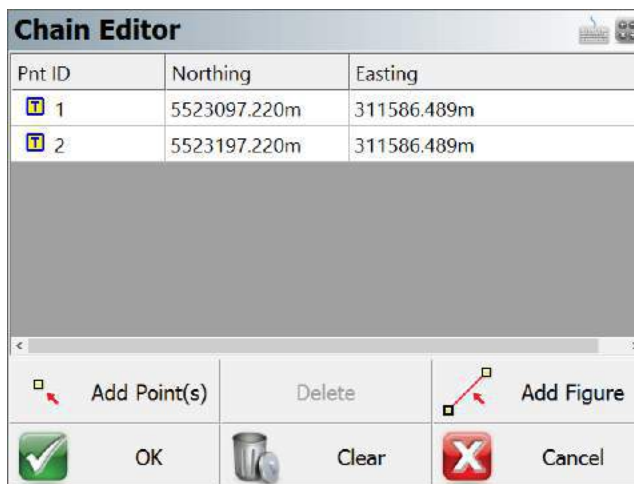
**Auto Profile**

After you press OK, you will be asked if you would like to create a vertical profile based on the chain point's elevation. If you select Yes, then you will be prompted for a Profile Name.

Vertical Profile

As mentioned above, a vertical profile can optionally be created automatically. If this option is chosen by the user, PVI points will be created for the profile. Each PVI point represents the points that make up the chain.

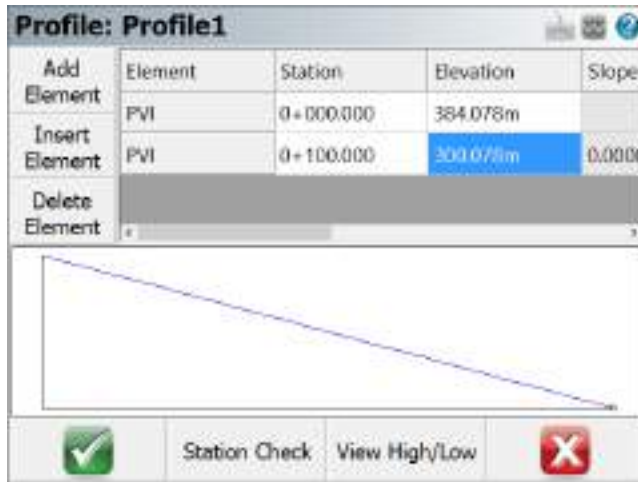

Manual Entry - Vertical Profile

[Main Menu](#) | [Roads Manager](#) | [Edit Road](#) | [Vertical Profile](#)

To create your vertical profile for your alignment, press the **Vertical Profile** button. When you do this you will see two options: New and Edit. Press **New** to create a new profile. If you want to edit an existing profile, then you need to select the profile, and then press the **Edit** button.

Delete Profile

You cannot delete a profile once it is created.

Profile Editor Overview

When you create a new profile you will see the profile editor. The **Add Element** button is the command center for you profiles and it allows you to add profile elements:

- PVI
- Parabolic Curve
- Unsymmetric Parabolic Curve
- Circular Curve

Once created, you can always edit and delete each element.

Station Check

Use this button to calculate an elevation along your vertical profile at the station you define. In the example below you will see the station entered was 0+150, and the computed elevation is 382.750.

The station check button can be used with all vertical element types.

Element	Station	Elevation
PVI	0+000.000	382.750m
Para	0+075.000	382.850m
Para	0+150.000	382.750m
Unsym	0+225.000	382.790m
PVI	0+275.000	382.800m

Check Station:

Elevation:

High / Low Display

When you use the High / Low button it will compute the high and low points for your vertical profile.



In the example above you can see that the high and low points are listed in the grid. This option can be used to display the high / low information for all vertical profile elements.

PVI Element

PVI elements are essentially straight grade segments that change direction at grade breaks. Each grade break (PVI) has to be defined by a station and elevation.



When you select to add a PVI element you will have two fields available where the station and the elevation at that station can be entered. Once you have a minimum of two PVI points, the slope of the line will be displayed.

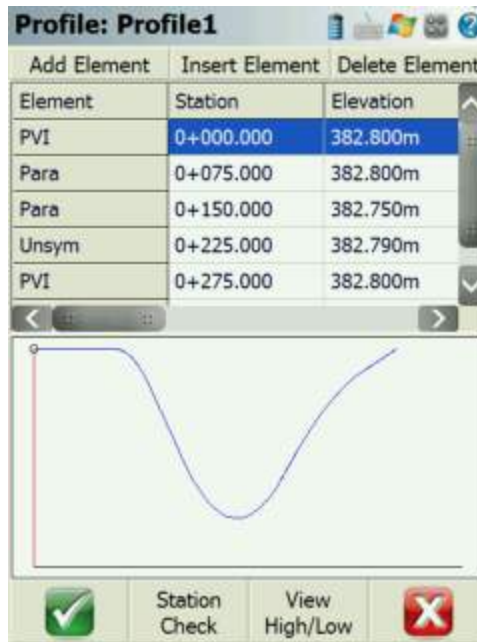

Parabolic Curve Element

This option allows you to enter an equal tangent vertical parabolic curve. At a minimum you need to know the **PVI Station**, **PVI Elevation**, and **Curve Length** for your vertical curve. Furthermore if this is a new profile you need to define a PVI point before the vertical curve, as well as define a PVI, Parabolic, or Unsymmetrical Parabolic curve after the vertical curve. Elements are needed before and after the vertical curve element so the profile editor can calculate the tangents.

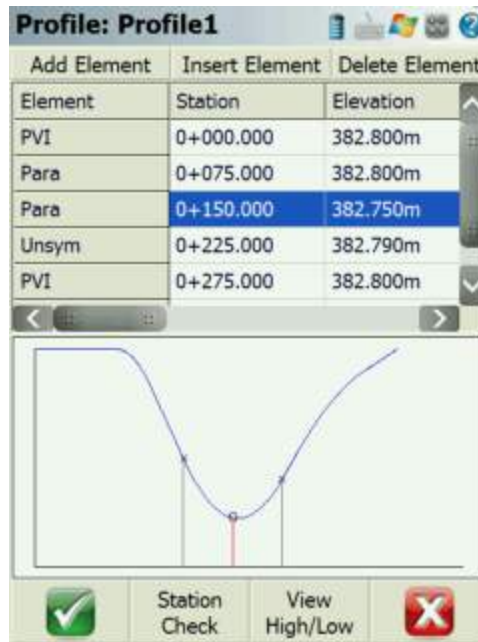

In the example you will see that a PVI was established for the beginning of the vertical profile. Then the PVI for the vertical curve was defined, as well as another parabolic curve. You will also notice that if you click a Para element, its location will be displayed in the display area.

Station Check

You can also do a station check on a parabolic vertical curve. Simply press the Sta Check button and enter the station you would like to compute an elevation for.

High / Low Calculation

With all vertical curves, the high or low point can be computed. For example, if we use the High/Low button to compute this information you will see the high point is at station 0+154.167 at an elevation of 382.761m.

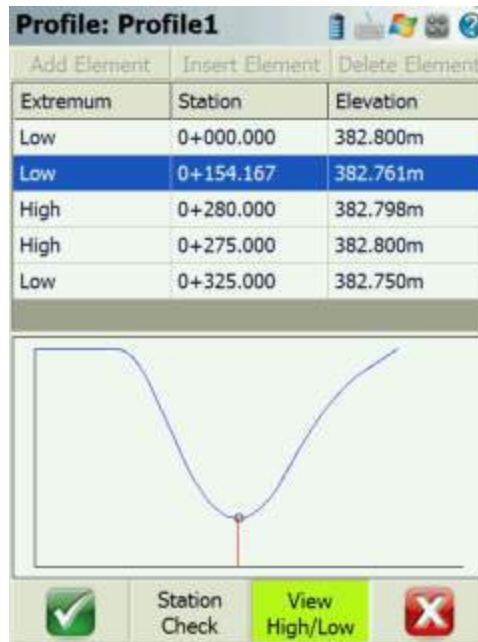

Unsymmetrical Parabolic Curve Element

This option allows you to enter an unequal tangent vertical parabolic curve. As a minimum you need to know the **PVI Station**, **PVI Elevation**, **Curve Length In**, and **Curve Length Out** for your vertical curve. Furthermore if this is a new profile you need to define a PVI point before the vertical curve, as well as define a PVI, Parabolic, or Unsymmetrical Parabolic curve after the vertical curve. Elements are needed before and after the vertical curve element so the profile editor can calculate the tangents.

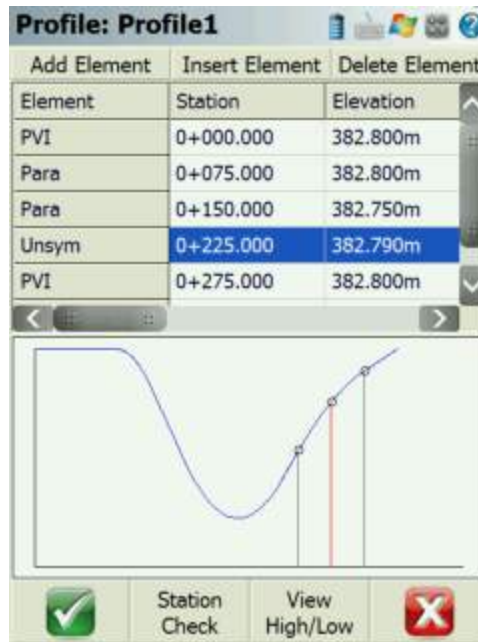

In the example you will see that a PVI was established for the beginning of the vertical profile. Then the PVI for the unsymmetrical vertical curve was defined, as well as another PVI element. You will also notice that if you click an Unsym element, its location will be displayed in the display area.

Station Check

You can also do a station check on an unsymmetrical vertical curve. Simply press the Sta Check button and enter the station you would like to compute an elevation for.

High / Low Calculation

With all vertical curves, the high or low point can be computed. For example, if we use the High/Low button to compute this information you will see the High point is at station 0+233.333 at an elevation of 382.786m.

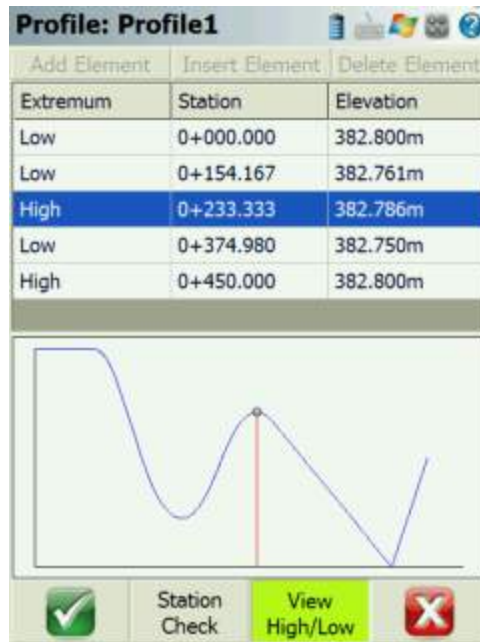

Circular Curve

This option allows you to enter an equal tangent vertical circular curve. At a minimum you need to know the **PVI Station**, **PVI Elevation**, and **Curve Radius** for your vertical curve. Furthermore if this is a new profile you need to define a PVI point before the vertical curve, as well as define a PVI, Parabolic, or circular after the vertical curve. Elements are needed before and after the vertical curve element so the profile editor can calculate the tangents.

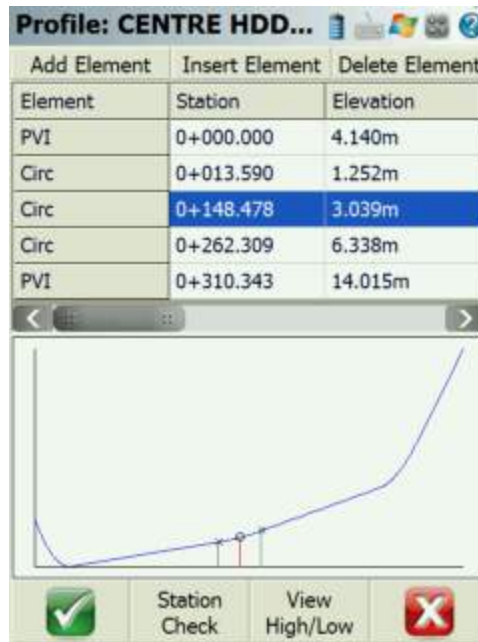

In the example you will see that a PVI was established for the beginning of the vertical profile. Then the first vertical circular curve was defined, as well as two more circular curve elements after and to finish it off, a final PVI is needed. You will also notice that if you click a circular curve element, its location will be displayed in the display area.

Station Check

You can also do a station check on a vertical circular curve. Simply press the Station Check button and enter the station you would like to compute an elevation for.

High / Low Calculation

With all vertical circular curves, the high or low point can be computed. For example, if we use the High/Low button to compute this information you will see the High point is at station 0+164.199 at an elevation of 2.661m.



Manual Entry - Template

[Main Menu](#) | [Roads Manager](#) | [Edit Road](#) | [Template](#)

You can define templates that will be used to create a cross section along your alignment. You can create new templates, and edit existing ones you've created. Each template can have unlimited zones right or left of the centerline. Each template can contain zone modifiers that can help you define sections that need widening or superelevation.

When you create a new template you will be asked for a template name. After you enter the name you will see the Template editor.

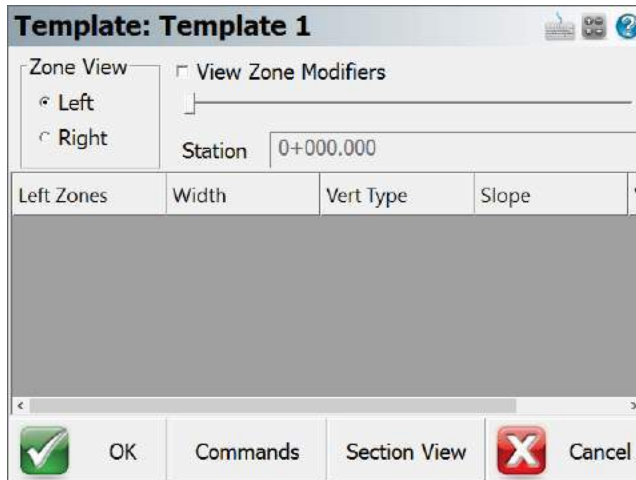

Add Zones

Many software programs refer to templates as having segments, in FieldGenius they are referred to as zones. Zones contain horizontal and vertical components, and these zones are located on the right or left of the template centerline.

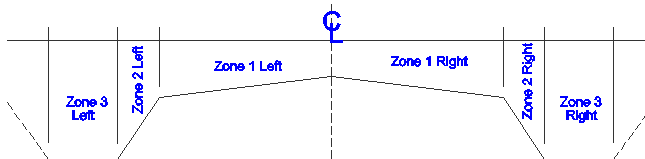

You first need to define what side of the centerline your zone belongs to: **Left** or **Right**.

Once you do that you can choose the **Add Zone** command from the **Commands** button.

When you select the add zone command you will see your first zone item appear in the grid area. You need to enter a horizontal width distance and then specify how you will be defining the slope for the zone. The slope for the zone can be defined by entering a slope value (%) or a vertical distance also referred to as a delta Z. In the example shown below you will see that three zones have been defined for the left side of the template.

By default all new zones are attached to the zone found furthest from the centerline.

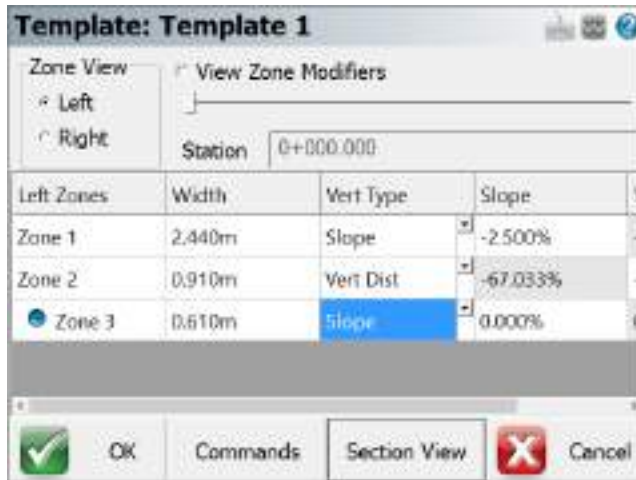

Delete Zones

Any zone that is highlighted in the zone list can be deleted by using the **Delete Zone** command. There is no undo, so be careful when you use this command.

Clear All

At any time, you can clear the zone list so you can start over. To do this use the **Clear Zone** command. There is no undo, so be careful when you use this command.

Mirror Zones

There are two variations of this command. You can mirror your zones from left to right, or right to left. In our example from above, when the **Mirror Left to Right** command is used, the zones are duplicated on the right side of the template.



Note: Depending on what side you're displaying, you will only see the zones listed for that side of the template. To see the zones for the other side you need to change to the opposite side using the Left Zone and Right Zone buttons.

Move Zone

Zones can be shifted around by moving them in or out from the centerline. To do this, use the **Move In** and **Move Out** commands.

View Zone Modifiers



The template you define is a typical cross section for the entire alignment. You can define changes to the template at specific stations and these changes are referred to as **Zone Modifiers**. Zone modifiers modify the typical template to allow for deviations such as road widening and super elevations.

This tool is meant to be used when you've defined zone modifiers. Please see the advanced template editing for more information.

Advanced Zone Edit

Advanced editing of your zones is available to give you even more power and flexibility. Being able to modify the zones at specific stations, allow you to create template transitions, widenings and super-elevation transitions.

You first need to highlight the zone you want to modify in the zone list. Once you do that press the **Advanced Zone Edit...** command. This will then display the zone editor for the zone you've selected, in this example it is zone 3.

Zone : zone3		Help
Slopes (0)	Cut/Fill (0)	Widths (0)
Zone Name	zone3	
Zone Priority	3000	
Start Station	5+00.00	
Start Width	5.00'	
Start Slope	0.000%	
Start DeltaZ	0.00'	
Add	Clear	Delete
 OK	 Cancel	

By default when you create a zone, the width, delta elevation and slope are used from the beginning of the zone to the end. The start and end stations are determined by start and end station defined in the horizontal alignment.

Slopes Modifier

When you use this button you will see the slope modifier page. On this page you can define different modifiers that change the slope or delta Z value for the zone.

Cut/Fill Modifier

When you use this button you will see the cut/fill modifier page. On this page you can define different modifiers that change the cut / fill value for the zone.

Note: This function is currently not implemented fully and is reserved for a future version. Cut/Fill Slope values from the hinge point can be set in the [Options](#) screen.

Widths Modifier

When you use this button you will see the widths modifier page. On this page you can define different modifiers that change the width value for the zone.

Advanced Template Editing

Advanced Zone Edit – Widening Example

In this example we will use the template example from the Template section. We want to widen the template at a specific station and change the grade of the template.

The original zone 3 has a constant elevation and width from beginning to end, but we want to modify it to include a section that has a slope and width difference.

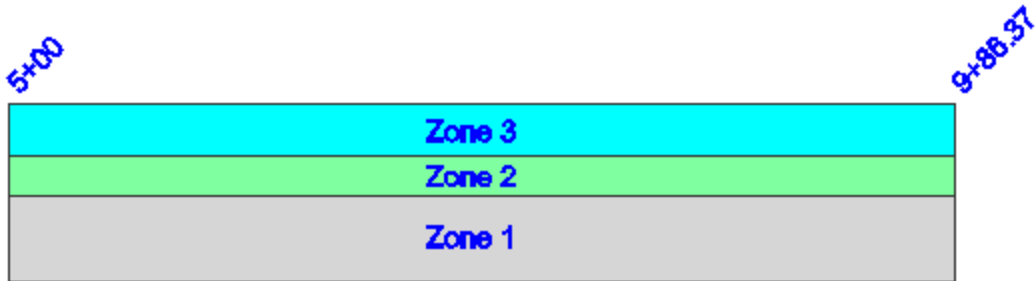

The new zone 3 will look like the following example. From station 6+00 to 7+00 the width of the zone transitions from a width of 5' to 10' and the elevation transitions from 0 down to -2'. Then from station 8+00 to 9+00 it transitions back to the normal width and grade.

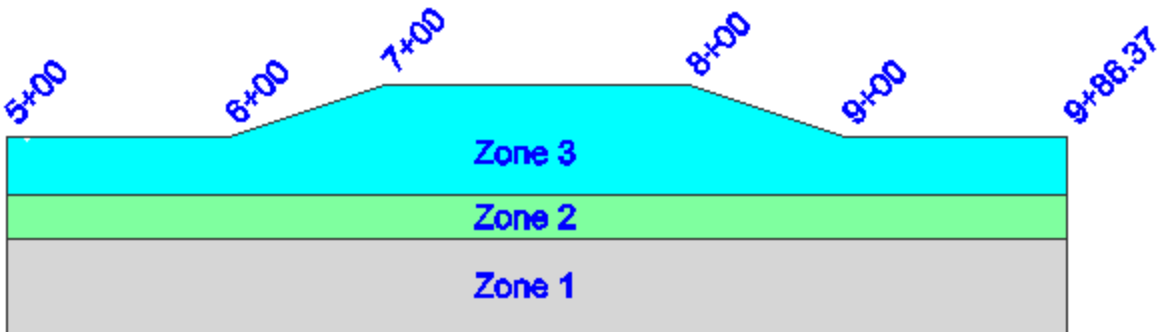

Slope Modifier

First you need to highlight the zone that you want to add modifiers to.

Then select the **Advanced Zone Edit** command from the commands button. This will open the zone modifier screen for the zone. In our example, we'll be modifying zone 3 on the left side of the template.

To add slope modifiers, press the **Slopes (#)** button. From here you can press the Add button to add modifiers for the zone. The following table shows the information that would have been inputted.

You have to define if you are entering a relative vertical change, or want FieldGenius to compute it for you using a slope percent and horizontal distance for the zone. You can do this by selecting the Vert Type and set it to Vertical Distance or Slope.

Start Station	Start Slope	Start Delta Z	End Station	End Slope	End Delta Z
6+00	0.0%	0.00	7+00	-20.0%	-2.00
7+00	-20.0%	-2.00	8+00	-20.0%	-2.00
8+00	-20.0%	-2.00	9+00	0.0%	0.00

Press **Ok** to save the modifiers.

Widths Modifier

First you need to highlight the zone that you want to add modifiers to.

Then select the **Advanced Zone Edit** command from the commands button. This will open the zone modifier screen for the zone. In our example, we'll be modifying zone 3 on the left side of the template.

To add width modifiers, press the **Widths (#)** button. From here you can press the Add button to add modifiers for the zone. The following table shows the information that would have been inputted.

Zone: Zone 3			
Slopes (0)		Cut/Fill (0)	
		Widths (3)	
Start Sta...	Start Wi...	End Stat...	End Width
6+00.00	5.00'	7+00.00	10.00'
7+00.00	10.00'	8+00.00	10.00'
8+00.00	10.00'	9+00.00	5.00'
Add Clear Delete			
✓ OK		✗ Cancel	

Press **Ok** to save the modifiers.

Checking Width Modifiers

At any time from the Template editor you can confirm that your modifiers are correct by using the station slider.

If we use our example from above, and want to preview the template at station 6+00, you can do so by entering it in the station field.

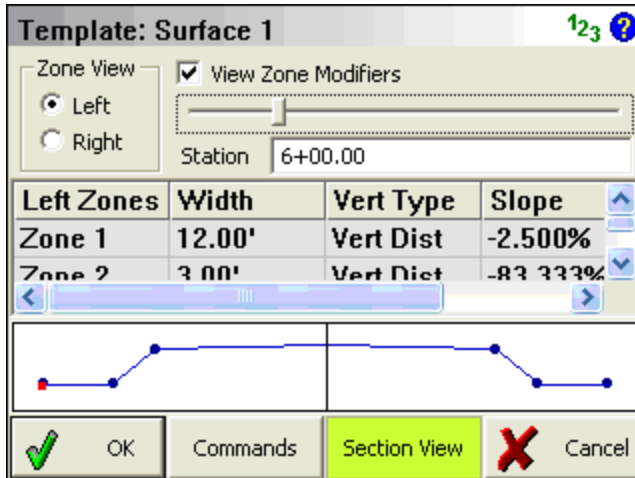

If we check station 7+00 you will see that the zone now extends further and drops down.

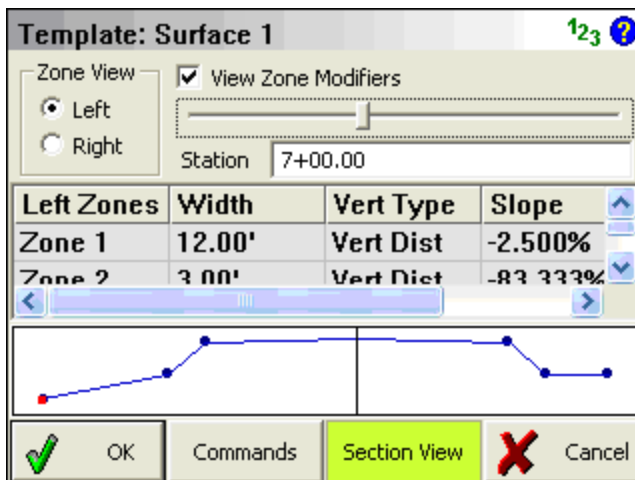

Advanced Zone Editing – Superelevation

In this example we will use the template example from the Template section. We want to add super-elevation data to our template so it can be staked in the field. FieldGenius cannot calculate surperel- evations; you need to know what delta z or slope the zone should be transitioning for your superelevation section.

To do this we will be adding slope modifiers to Zone 1 L and Zone 1 R.

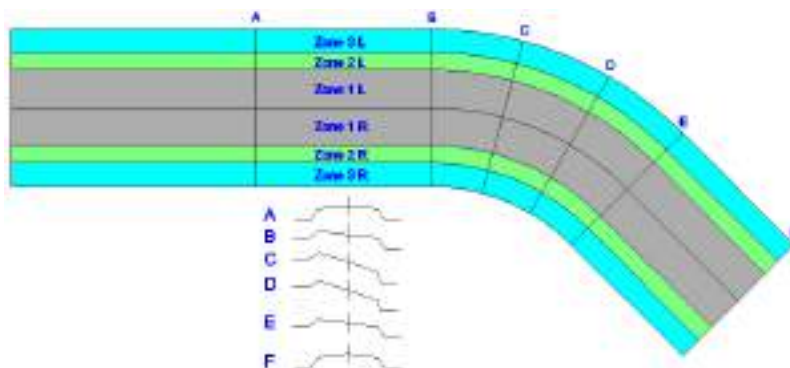

Labels A to F show the stations where we will be adding modifiers to modify the template so the road transitions from normal crown to full superelevation and back. **Note:** In this example the super-elevation is exaggerated for ease of viewing.

Slope Modifier

First you need to highlight the zone that you want to add modifiers to.

Then select the **Advanced Zone Edit** command from the commands button. This will open the zone modifier screen for the zone. In our example, we'll be modifying zone 3 on the left side of the template.

To add slope modifiers, press the **Slopes (#)** button. From here you can press the Add button to add modifiers for the zone. The following table shows the information that would have been inputted.

Left Side Zone 1					
Start Station	Start Slope	Start Delta Z	End Station	End Slope	End Delta Z
900	-6.7%	-0.80	1000	6.7%	0.80
1000	-13.3%	-1.60	1078.54	13.3%	1.60
1078.54	-26.7%	-3.20	1157.08	13.3%	1.60
1157.08	-26.7%	-3.20	1235.62	6.7%	0.80
1235.62	-13.3%	-1.60	1300	-6.7%	-0.80

Right Side Zone 1					
Start Station	Start Slope	Start Delta Z	End Station	End Slope	End Delta Z
900	-6.7%	-0.80	1000	-13.3%	-1.60
1000	-13.3%	-1.60	1078.54	-26.7%	-3.20
1078.54	-26.7%	-3.20	1157.08	-26.7%	-3.20
1157.08	-26.7%	-3.20	1235.62	-13.3%	-1.60
1235.62	-13.3%	-1.60	1300	-6.7%	-0.80

Press **Ok** to save the modifiers.

Checking Width Modifiers

At any time from the Template editor you can confirm that your modifiers are correct by using the station slider.

If we use our example from above, and want to preview the template at station 9+00, you can do so by entering it in the station field. You will see at this station we have a typical road cross section.

Template: Surface 1 123 ?

Zone View View Zone Modifiers

Left
 Right

Station

Right Zo...	Width	Vert Type	Slope
<input checked="" type="radio"/> Zone 1	12.00'	Vert Dist	-6.667%
<input type="radio"/> Zone 2	3.00'	Vert Dist	-83.333%

OK Commands **Section View** Cancel

If we check station 10+78.54 you will see that we are at the full superlevation section.

Template: Surface 1 123 ?

Zone View View Zone Modifiers

Left
 Right

Station

Right Zo...	Width	Vert Type	Slope
<input checked="" type="radio"/> Zone 1	12.00'	Vert Dist	-26.667%
<input type="radio"/> Zone 2	3.00'	Vert Dist	-83.333%

OK Commands **Section View** Cancel

LandXML Cross Sections

[Main Menu](#) | [Roads Manager](#) | [Edit Road](#) | [Cross-Sections](#)

LandXML cross sections are created with desktop software such as Eagle Point, Caice, LDD and many others.

If you import a LandXML file that has cross sections in it, you can immediately go to the Roads Manager and select the road to stake. You will see the roads in the Cross-Sections list. Choose one, then press the Stake Roads button you will see the stake Alignment screen.

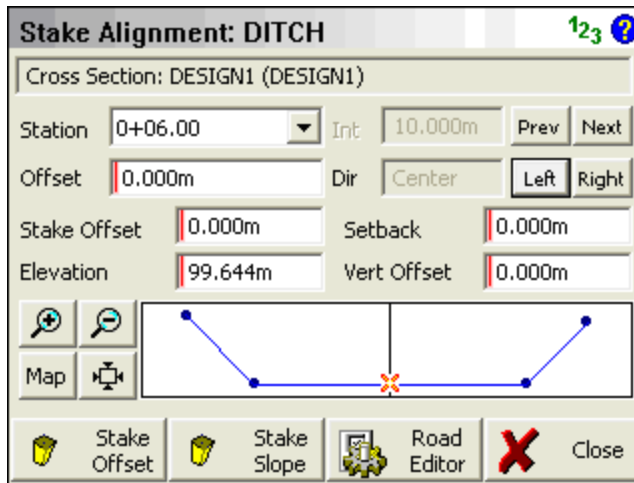

Please see the [Stake Alignment](#) section for more information about using this command.

Alignment DTM Surface

[Main Menu](#) | [Roads Manager](#) | [Edit Road](#) | [DTM Surface](#)

If you've imported a surface file, either through the [QSB or LandXML importer](#), you can stake to the surface along a defined horizontal alignment.

All you need to do is define the alignment using the **Alignment C/L** button then select a surface from the surface drop down list found next to the **DTM Surface** button.

When you press the **Stake Road** button you will see the alignment screen. In the area where you would normally see your cross section or template, you will now see the surface at the stake station you have defined.

If you enter a Design Offset, it will compute an elevation based on the surface.

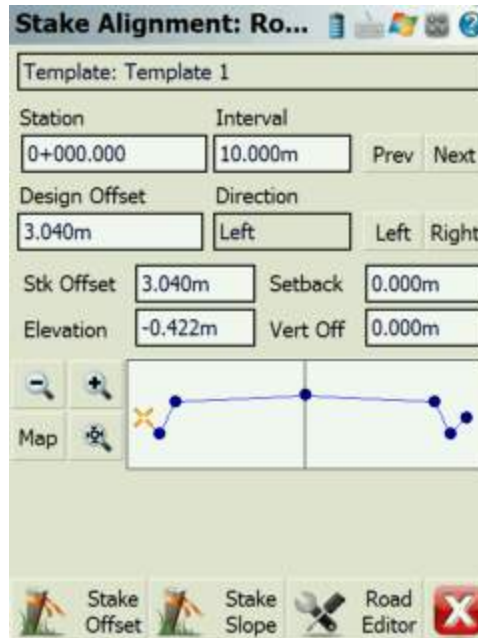

Alignment Staking - Part 1

There are two things that have to happen before you can stake a road.

1. You have to create an alignment, vertical profile and a template. Or...
2. Import a LandXML file and use XML cross sections to stake from.

Stake from Alignment, Profile and Template.

If you've taken the time to define your alignment, you need to select the vertical profile and template that you want to stake from in the road settings screen.

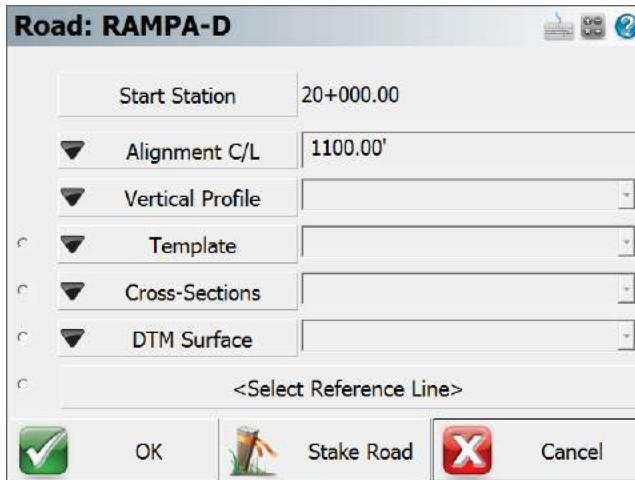

Use the **Stake Road** button to start the road staking which will display the Stake Alignment screen.



Station and Station Interval

If you enter a station interval, it will move forward and back along the alignment by this amount when you use the **Prev** and **Next** buttons. This interval will start from the station that is currently entered in the Stake Station field.

Stake Station

You can also manually enter the station you would like to stake by entering it in the Station field.

Design Offsets

Move Along Template

You can move along the template by using the **Left** and **Right** buttons. As you do this the offset from the centerline will be displayed in the Offset field. Furthermore you will see what side of the template you're on by looking at the direction field. You will also note in the template preview, the "x" visually marks the design offset.



Define an Offset

You can define your own offset to stake by entering the value in the Offset field. To enter a Left offset, use a negative value.



Stake Offset and Setback

Stake Offset

By default the Stake Offset will equal the Offset value. The stake offset is designed to help you enter the offset that you want to stake your point at. Sometimes, the contractor asks you to stake a point at a certain distance from the centerline, this will help you do that.

Setback

The setback and stake offset fields work in conjunction with one another. You will note that as you enter a stake offset, a value is computed in the setback field. This value is computed by subtracting the Stake Offset from the Design Offset.

If you know that the offset or setback for a template point is to be a specific value, enter the value in the setback field; the stake offset field will update automatically.



You will note that when a setback or stake offset is defined, you will see an orange circle in the preview screen. This circle indicates the location of the setback.

Note: If you want to make sure that you're staking nothing but design points along the template, then make sure the Setback field is equal to 0.0.

Elevation and Vertical Offset

Elevation

The field will show you the computed elevation on the template at the design offset specified. This value can be changed to allow you stake a different elevation.

Vertical Offset

This field works in conjunction with the elevation field. If the user enters a different elevation than the one that was computed on the template, the difference between the elevations is shown in the vertical offset field.

If you know what the vertical offset is for the point you're staking on the template, you can enter it in this field. You will see the elevation for the point update to reflect the offset you defined.



In the template preview screen you will see an orange circle. This circle indicates the location of the vertical offset point that will be staked.

Note: If you want to make sure that you're staking nothing but design points along the template, then make sure the Setback field is equal to 0.0.

Template Preview

You can zoom into your template using the zoom controls. You can also pan the template by tapping on it and dragging it on the screen.

Use the Map button to display the location of the template along your alignment. This will be displayed in the map view window.

Stake Offset

Once you've defined that point you want to stake, you can select the **Stake Offset** button to start the staking process. When you press this button you will see the staking toolbar. For an explanation of the staking toolbar and alignment staking, please refer to the next section, [Alignment Staking - Part 2](#).

Stake Slope

This is the **Stake Slope** toggle. Normally you will slope stake from the hinge point on the template, but it is totally up to you. The slope staking feature can be used from any point on the template.

Road Settings

Press this button to return to the road settings screen.

Stake from LandXML Cross Sections

To stake cross sections from a LandXML file you first need to import it using the LandXML importer found in the Import Menu.

You can then select the alignment from the map screen to open the Roads Manager, or you can access it from the **Roads Menu**. In this menu you can select the alignment that has the cross sections, and then press the **Road Settings** button.

You then have to select the cross section that you want to use by selecting it in the cross sections field.

The screenshot shows a dialog box titled "Road: maple". It contains the following fields and options:

- Start Station: 0+000.000
- Alignment C/L: 447.607m
- Vertical Profile: maple
- Template: (empty)
- Cross-Sections: DESIGN1 (DESIGN)
- DTM Surface: (empty)

At the bottom, there are four buttons: "OK" (with a green checkmark), "Stake Road" (with a road icon), "Cancel" (with a red X), and an unlabeled button (with a red X).

When you press the **Stake Road** button you will see the Stake Alignment screen which is described in detail above.

Stake Alignment with a Reference Line

To stake to an Alignment using a Reference Line the user needs to first import in a XML file containing an alignment then a DXF file is needed for the Reference Line information. Use the Importer feature found in the main menu to bring in both data files.

After this is completed go into the Roads Manager to select which road alignment to use. Continue by pressing the Manage Road button to take you to the Road Settings page. The Alignment info should be updated and reflect a valid Start Station and Alignment C/L length. From here the user must define a line by pressing the Select Reference Line button at the bottom of the list of settings.

By pressing this it will take the user to the Map View where you can navigate around the screen to select the appropriate DXF linework to be used in as the Reference Line in the routine. Once selected press the OK button to take you back to the Road Settings page where the label for that line will now be displayed.

Road: RAMPA-D	
Start Station	20+000.00
Alignment C/L	1100.00'
Vertical Profile	
Template	
Cross-Sections	
DTM Surface	
DXF: Surf_Shldr_Pr_Agg_Edge~	
	OK
	Stake Road
	Cancel

Press the Stake Road button if you are satisfied with the selected road alignment and reference line to proceed to the Stake Reference Line setup page.

Stake Reference Line: RAMP-A-D

Alignment Station

Stake 20+044.00 - + Int 10.00'

Auto [Increment] Station by Interval after Store

Include Element Transition Points

Reference Line Offsets

Horiz 0.00' - + Int 1.00'

Vert 0.00'

Stake Reference Line X Cancel

From the Stake Reference Line dialog the user can customize the features work flow by the following settings;

Alignment Station

In this section the user has the ability to set which Station location to start at and the interval distance to use when proceeding to the next station. There are additional settings to further control the moving from one station to another.

The AUTO check box when check ON will automatically move up the next station interval by either incremental or decremental along the alignment after a point has been stored.

The Include Element Transition Points check box when checked ON will stop at the next vertical and horizontal deflection point along the alignment. This will ignore the station interval value to ensure a key transition point is not skipped over.

Reference Line Offsets

Here the user can enter in a Horizontal and Vertical offset value. This offset will be calculated from the point on the referenced line. An interval can also be applied here manually for the horizontal offset value.

When you are satisfied with the values entered press the Stake Reference Line button to continue to the Stake Point screen. After a point has been successfully staked out and stored the routine will go back to the Stake Reference Line window. Alternatively pressing the Cancel if you wish to back out to the Map View screen.

Alignment Offset Staking

Continued from [Alignment Staking...](#)



From the stake alignment screen, when you press the **Stake Offset** button if you are staking with a robotic instrument or GNSS you will immediately see the staking toolbar. If you are staking with a conventional instrument you will see the turn-to information first, directing you to the design point.

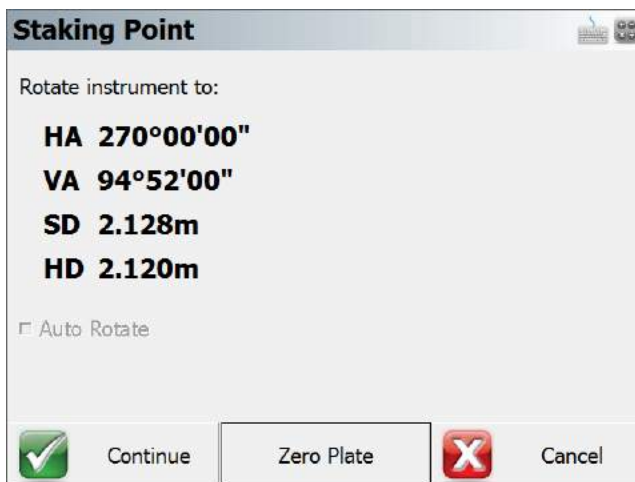

The alignment offset staking process is very similar to normal [point staking](#). What is different is you will see the station/offset information about where the prism is in relation to the alignment and more importantly, to the point you're staking.

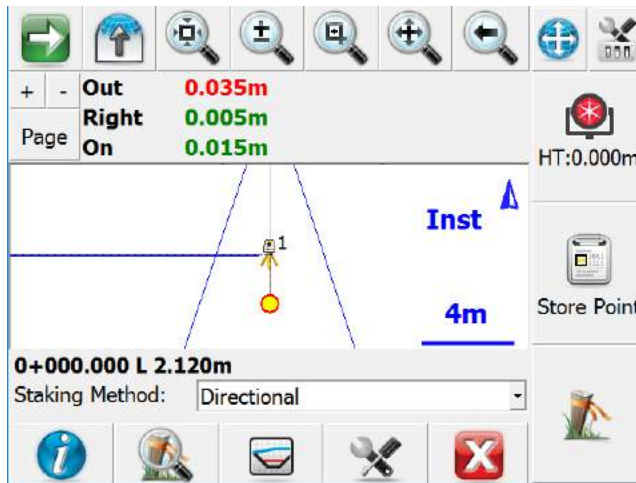

Staking Method

Turn an Angle: You will see the horizontal angles to the design point and to your actual measurement. This is useful for getting online (left/right) with a conventional total station.

Directional: You will see the move distances (In/Out/Left/Right or N/S/E/W, as well as Cut/Fill) guiding you from the actual measurement to the design point.

Radial: You will see a direction and distance guiding you from the actual measurement to the design point.

Stationing - Absolute: You will see the offset of the actual measurement along the alignment.

Stationing - Relative: You will see the move distances guiding you along the alignment from the actual measurement to the design point.

Staking Information

The **station/offset of the design point** is indicated directly on the staking toolbar, and also in the Staking Information screen which you can access by pressing the Info button in the staking toolbar.

The **station/offset of the actual measurement** is available in the Staking Information screen.

The **move or rotate information** which will guide you from the actual measurement to the design point is indicated in the [observation toolbar](#). You can press the Page button to toggle between various information if you do not see these values. If your measurement is within your defined tolerance of the design point then the text will be green, if not then the text will be red. This information is also available in the Staking Information screen. The type of information shown will vary based on your current Staking Method.



Template Preview



At any time during your staking you can press the Profile button to see the actual rod position which will be shown as an orange circle, in relation to the template defined for the alignment.

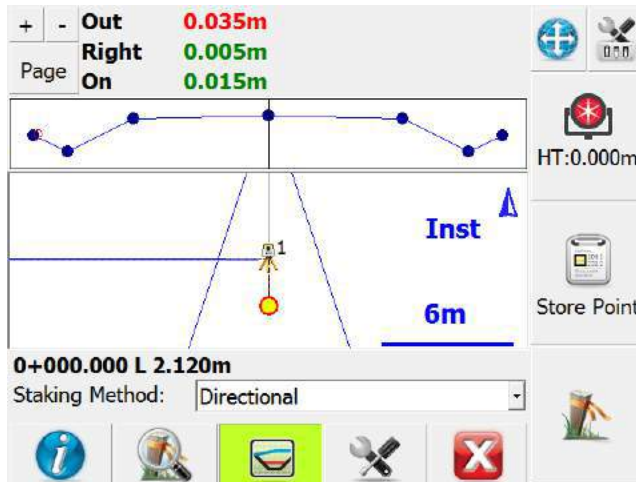

Zoom Stake

If you press the Zoom Stake button in the staking toolbar, you will be zoomed in to show you both the design point and the actual measurement. The green circular area surrounding the design point reflects the area where you are within the defined staking tolerances.

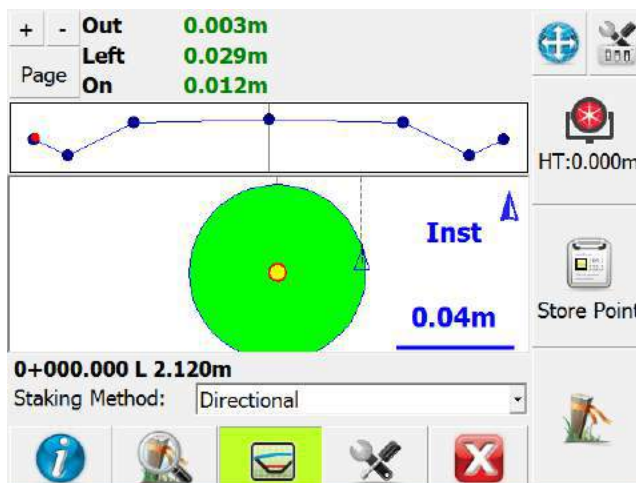

Store Point

When you are ready to store the stake point press the **Store Point** button. You will then see the results for your stakeout.

If you are using GNSS to stake the alignment, then you will not see the Store Point button. Instead, press the Measure button to trigger a measurement and then store the resulting shot.



Press **Save Point and Raw Data** to store a point for this shot and to write your stake and cut sheet records to the raw file. By default the description for the stored stake point will equal the station and offset that was being staked.

Press **Save Raw Data** to write your stake and cut sheet records to the raw file, without storing a point.

If you press **Cancel**, nothing is stored or written to the raw file.

Records written to raw file

Following are the records that are written to the raw file when you store a point.

If you do not store a point then the SP (Store Point) record is not recorded as no point was stored in the database.

```
SP,PN4,N 20000.0068,E 5000.0099,EL100.1038,--0+00.00 C 0.000
CF,ST0.000,OD1,OLO.010,EL100.1038,GD100.0000
OE,ST0.000,OE0.010
DE,PN,N 20000.000,E 5000.000,EL100.000,--
SD,ND-0.007,ED-0.010,LD-0.104
SK,OP1,FP4,AR201.48000,ZE93.10000,SD269.6600,--0+00.00 C 0.000
```

Alignment Slope Staking

Continued from [Alignment Staking...](#)

When you're staking a point from a template, you can select the **Stake Slope** button from any point. However, you will usually slope stake from the hinge points on your template.



When you start slope staking and you measure your first shot, the program computes an intersection between a horizontal plane containing the measurement and the slope defined in the [stake settings](#) from the hinge point. FieldGenius will then compute a best guess location for the catch point and will tell you how much you need to move. After you measure a second shot, FieldGenius will create an imaginary line between the two shots and intersects the slope from the hinge point. It then computes a new solution for the catch point.

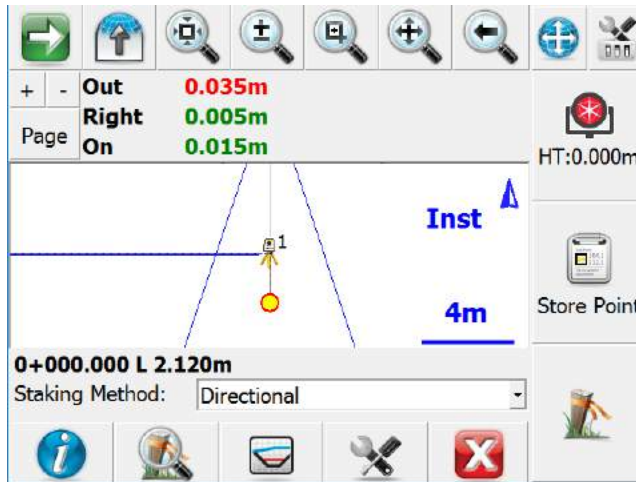

At any time during your staking you can press the Profile button to see the actual rod position which will be shows as an orange circle. You will also see the slope lines from the hinge point.

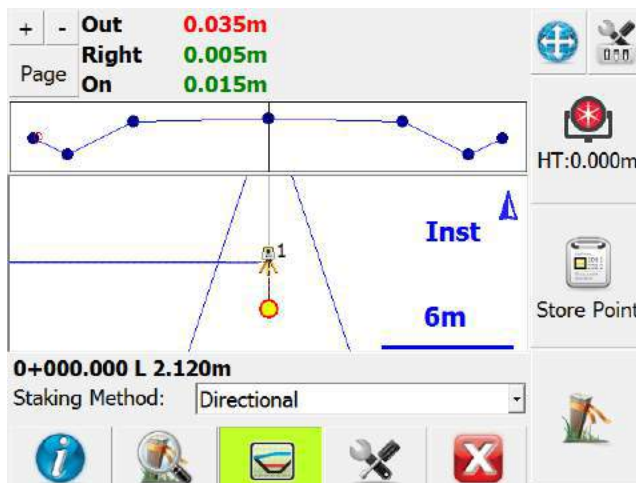

When you get near the catch point if you press the Zoom Stake button you will see a green circle in the map view representing the area within your specified staking tolerances.

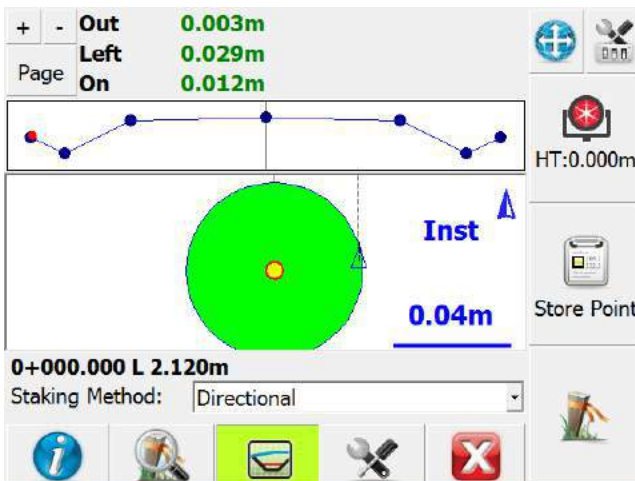

Slope Staking Results

When you store your catch point position you will see the results screen. This screen will always report the following:



Cut or Fill Slope: The first line will always tell you if you staked a cut slope or fill slope. It will also display the design slope that was specified and record the actual computed slope that was staked.

Station: This will display the station of the template or cross section, and will show the actual station staked at the catch point.

Hinge Point: This is the distance from the rod position to the hinge point. It will also indicate the vertical distance from rod position to the hinge point. A cut indicates that the hinge point is lower; fill indicates that it is higher than the current rod position.

Center Line: This is the distance from the rod position to the centerline. It will also indicate the vertical distance from rod position to the centerline. A cut indicates that the centerline is lower; fill indicates that it is higher than the current rod position.

Save Shot

Press **Save Point and Raw Data** store a point for this shot and to write your stake and cut sheet records to the raw file. By default the description for the stored stake point will equal the station and offset that was being slope staked. An example of an auto generated description is **CP 4+00.00 R 22.000**. The CP stands for Catch Point.

Press **Save Raw Data** to write your stake and cut sheet records to the raw file, without storing a point.

If you press **Cancel**, nothing is stored or written to the raw file.

Records written to raw file

Following are the records that are written to the raw file when you store a point.

If you do not store the staked point, the SP (Store Point) record will not be recorded as no point was stored in the database.

```
| SP,PN81,N 5002.9770,E 4997.8367,EL99.9829,--CP 0+12.00 L 1.000 |
| SL,ST12.000,OD2,EL99.983,GD99.983,AS0.005,HH0.985,VH0.966,HC1.985,VC0.966, |
| CF0,DS1.000000,OB1.019583 |
| SK,OP100,FP81,AR282.28000,ZE90.16000,SD3.6800,--CP 0+12.00 L 1.000 |
```

Slope Staking with Offset/Setback

In the Stake Alignment screen if you specify a stake offset or a setback distance, after you store your catch point position you will be asked if you want "Continue with staking the catch point setback?" If you press **No**, then this will be cancelled.

When you press **Yes**, you will then see the "Turn To" screen which will stake a position that is offset from the computed catch point. This offset will be equal to the offset you specified in the alignment screen.

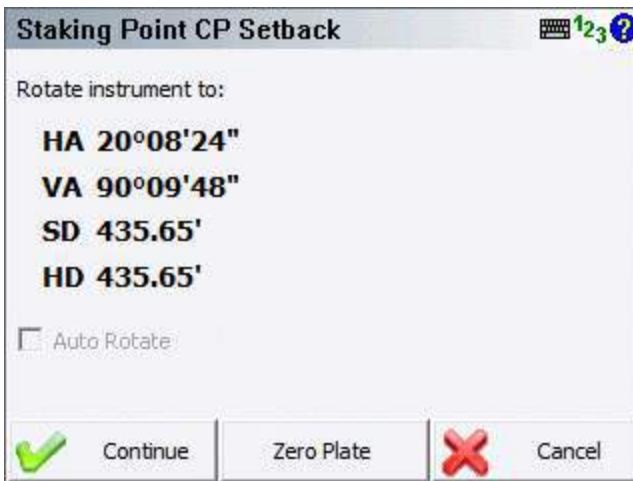

Now on the staking toolbar you will see the word **Stk: Pnt CP Setback** which indicates you're currently staking a slope stake setback point.

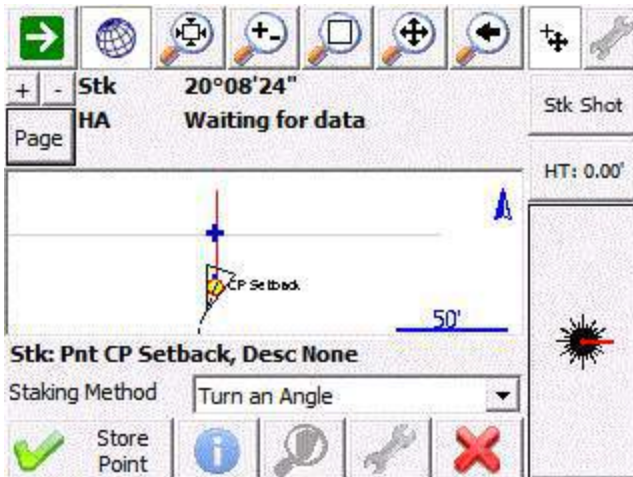

When you get to the offset position and store the point you will see the results screen once again. This time, the offsets to the hinge point and centerline will include the offset distance.

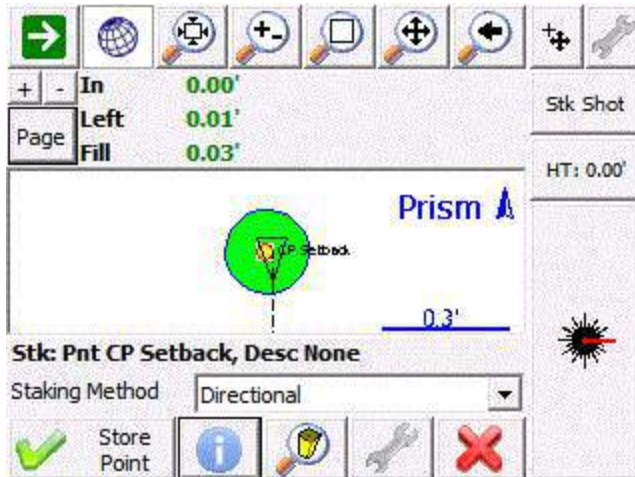

The vertical distances that are reported on the results screen are not computed using the current rod position. These values will be in relation to the actual catch point that was staked.



When you store the point you will see that the description that is auto generated for the point will be similar to the following example. **REF CP 4+00.00 R 24.00**

Records written to raw file

Following are the records that are written to the raw file when you store a point.

If you have the Store Staked Point toggle turned off in the stake settings screen, you will see that no SP record is recorded as no point was stored in the database.

```
| SP,PN5004,N 5007.7522,E 5001.5139,EL100.1445,--CP 0+06.00 L 1.000  
| SL,ST6.000,OD2,EL100.144,GD100.144,AS-  
| 0.002,HH0.498,VH0.501,HC1.498,VC0.501,CF0,DS1.000000,OB0.994169  
| SK,OP101,FP5004,AR353.45220,ZE90.23420,SD13.9200,--CP 0+06.00 L 1.000  
| SP,PN82,N 5007.2194,E 5002.2307,EL102.2842,--REF CP 0+06.00 L 2.000  
| SR,ST6.000,OD2,EL102.284,GD100.144,AS-  
| 0.002,HH2.390,VH0.501,HC2.387,VC0.501,CF0,DS1.000000,OB0.994169,OL1.000  
| DE,PNCP Setback,N 5007.078,E 5002.253,EL100.144,--  
| SD,ND-0.141,ED0.022,LD-2.140  
| SK,OP101,FP82,AR351.10340,ZE82.00000,SD14.6850,--REF CP 0+06.00 L 2.000
```

TOTAL STATION REFERENCE

Make and Model Settings

FieldGenius includes instrument and GNSS drivers for most popular brands. This list of supported hardware is constantly changing and for a complete list of supported hardware, please visit the following webpage: <http://hardware.microsurvey.com>

Total Station Profile

[Main Menu](#) | [Connect](#) | [Edit Total Station Profile](#)

This screen will help you configure your total stationing settings such as the make and model of instrument you plan on using and set any desired parameters you may need to use with your instrument. This option will only be available if you specified **Total Station** in the [Instrument Selection](#) screen and then **Edit** a profile.

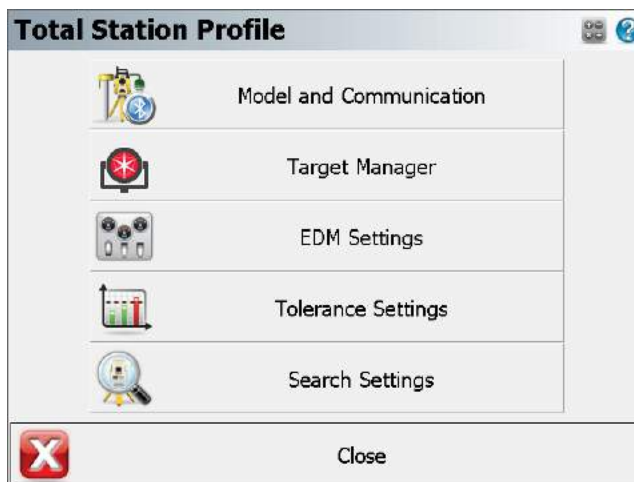

Model and Communication

This allows you to specify the make and model of instrument that will be connected to FieldGenius. You can also specify the communication settings such as baud rate and com port. See the [Model and Communication](#) topic for more information.

Target Manager

This allows you to create, copy, and delete targets in FieldGenius. You can define a unique backsight and foresight target for example. See the [Target Manager](#) topic for more information.

EDM Settings

This allows you to specify if you will be using prism offsets in FieldGenius and allows you to specify tolerances that will be used to ensure your EDM measurement meet your criteria. See the [EDM Settings](#) topic for more information.

Tolerance Settings

This allows you to specify angular distance tolerances that will be used by the traverse routines. See the [Measurement Tolerance](#) topic for more information.

Search Settings

When using a robotic instrument, you can specify search window parameters. See the [Search Settings](#) topic for more information.

Model and Communication

[Main Menu](#) | [Connect](#) | [Edit Total Station Profile](#) | [Model and Communication](#)

This is where you can specify the make and model of instrument you will be connecting to, as well as specify your communication parameters.

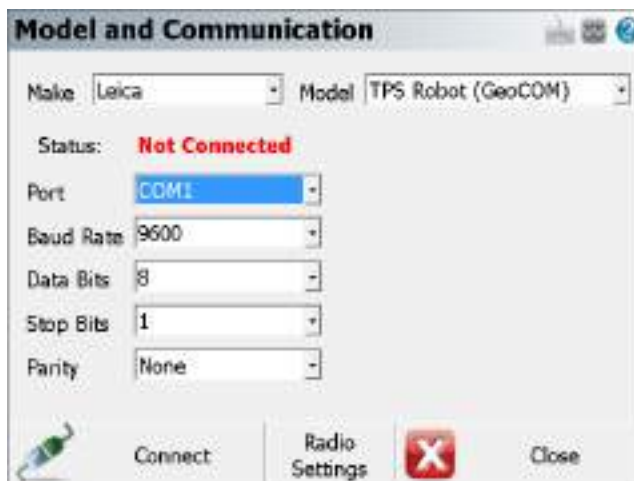

Total Station Make

Use this to select the make of your instrument.

Total Station Model

Use this to select the model of your instrument.

Status

This indicates whether FieldGenius is Connected or Not Connected to your instrument.

Port, Baud Rate, Data Bits, Stop Bits, and Parity

If you know the settings of your instrument you can set them here in FieldGenius. They have to match exactly the ones on your instrument or you will get a communications error when you try to connect.

It is important to confirm these settings on your instrument when you're trying to connect FieldGenius for the first time! Most connection problems occur because the user has specified parameters that don't match the ones on their instrument.

On many data collectors you can select Bluetooth as your communication port. If you select the Bluetooth port, the traditional serial communication options (Baud Rate, Data Bits, Stop Bits, Parity) will be replaced with a Bluetooth Search function.

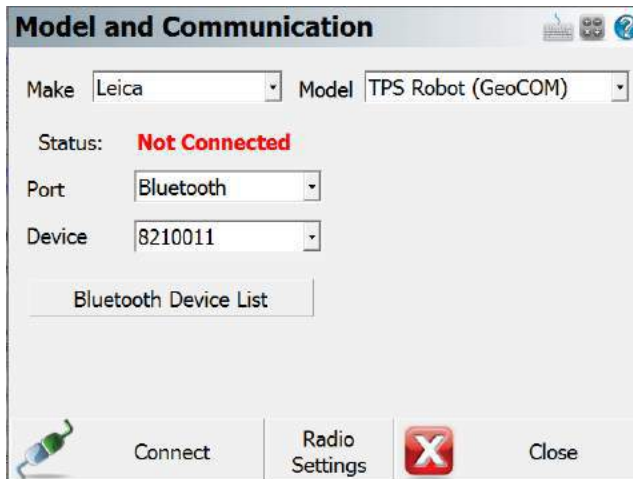

Please note that not all Bluetooth-enabled devices will list Bluetooth as a Port option. In some cases you must configure and use a virtual COM port through Windows CE's internal Bluetooth Settings, for example COM6.

Bluetooth Search

If you set the port to Bluetooth, a **Bluetooth Search** button will appear. Press the search button to find the device you want to communicate wirelessly with. All devices within range will be listed, choose the one you want to use

The device you selected will be saved into your instrument profile for future use so you do not need to Search every time.

Bluetooth PIN

After initiating a Bluetooth connection, you will be prompted to enter the PIN (passkey) for the instrument you are connecting to. If your instrument does not need one just leave it blank and continue by pressing OK.

The PIN you enter will be encrypted and stored in your instrument profile.

RC Port

If you are connecting with a Topcon Robot, you can specify which port on your data collector the RC unit is connected to.

Radio Settings

Use this to set the communication parameters for your radios or other communication device, such as the channel or frequency. You can also use it to specify a direct connection to FieldGenius instead of using radios. Please see the [Radio Settings](#) topic for additional information.

Connect

Use this to connect to your instrument after you have specified your communication settings.

If you see the following message, "No communication with instrument. Check settings, cables and power." read the [No Communication](#) topic for possible causes.

FieldGenius connects successfully, the Status will change to "Connected", and if your instrument supports graphical representation of the level bubble, you will see the [Check Level](#) screen.

Radio Configuration

[Main Menu](#) | [Connect](#) | [Edit Total Station Profile](#) | [Model and Communication](#) | [Radio Settings](#)

Use this to specify if you want to connect to your robotic instrument using a direct connection or through the instrument's radios. If you're using a Topcon, you can specify your RC unit as the communication device and assign a COM port for it. Press the Radio Settings to bring up the options for what type of radio you are using to connect to the Topcon instrument.

Model and Communication

Make: Model:

Status: **Not Connected**

Port: RC Port:

Device:

Radio Settings

Connection Method

Direct RC Optical SS Wireless RC-4R

Connection

Direct

This will allow you to connect directly to your instrument through an instrument cable.

Radio

This will allow you to connect to your instrument using external radios. Select your radio channel, if this option is available.

Note: If you are using radios with your instrument but this option is disabled or not available, then pick the Direct option instead.

RC

This will allow FieldGenius and your instrument to communicate through the RC unit.

EDM Settings

[Main Menu](#) | [Connect](#) | [Edit Total Station Profile](#) | [EDM Settings](#)

[Total Station Toolbar](#) | [Instrument Settings](#) | [EDM Settings](#)

From here you can specify EDM settings such as prism offsets and measurement modes.

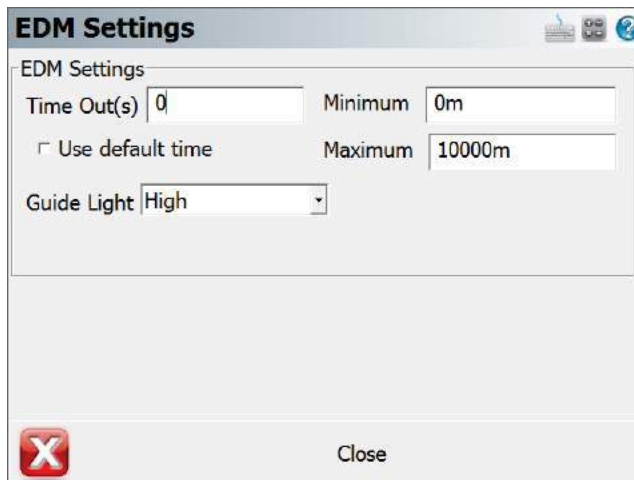

EDM Settings

Time Out (s)

Use this to specify the length of time FieldGenius will try to receive a measurement from your instrument. You may need to set this to a higher number if you're trying to receive measurement in wooded areas or long sights.

Use Default Time Out

If this is checked on FieldGenius will use a default time out value. If you would like to change it you need to uncheck it and update the **Time Out** field.

Minimum and Maximum

You can specify the minimum and maximum distance that FieldGenius will accept as being valid. Example is if you set this the minimum to 10 feet and you measure 5 feet, FieldGenius will not record the measurement and will display a "Distance out of range" error in the status toolbar.

Guide Light

If your instrument has guide lights you will be able to set their intensity modes here. Please refer to your owner's manual for more information on the different intensities.

Measurement Tolerance

[Main Menu](#) | [Connect](#) | [Edit Total Station Profile](#) | [Tolerance Settings](#)

[Total Station Toolbar](#) | [Instrument Settings](#) | [Tolerance Settings](#)

Use this to set tolerances that are used when you're using the multi-set collection function in FieldGenius.

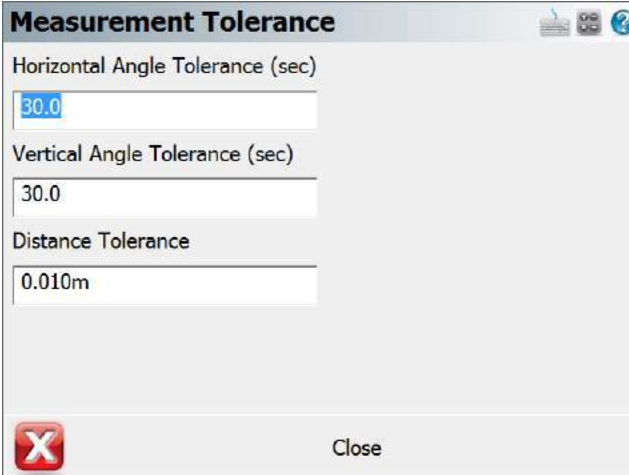

Measurement Tolerance

Horizontal Angle Tolerance (sec)
30.0

Vertical Angle Tolerance (sec)
30.0

Distance Tolerance
0.010m

X Close

Horizontal Angle Tolerance (sec)

Use this to specify the tolerance for your horizontal angles in seconds. When you store your multi-set point, if the Standard Deviation exceeds this value you will be notified when you store the point.

Vertical Angle Tolerance (sec)

Use this to specify the tolerance for your vertical angles in seconds. When you store your multi-set point, if the Standard Deviation exceeds this value you will be notified when you store the point.

Distance Tolerance

Use this to specify the tolerance for your measured distances. When you store your multi-set point, if the Standard Deviation exceeds this value you will be notified when you store the point.

Please refer to the [Multi-Set](#) topic for more information on how to record a set.

Search Settings

[Main Menu](#) | [Connect](#) | [Edit Total Station Profile](#) | [Search Settings](#)

[Total Station Toolbar](#) | [Instrument Settings](#) | [Search Settings](#)

When using a robotic or motorized instrument you can specify search settings for your instrument.

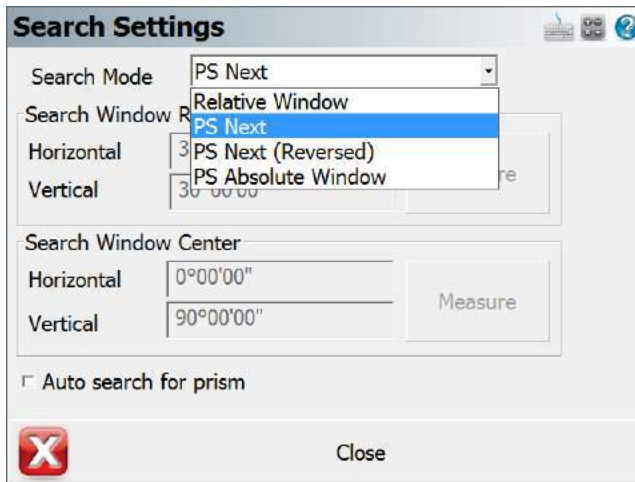

Search Modes

Some of FieldGenius's search modes are common to all robotic instruments, but there are a few model specific ones. The modes available are:

Relative Window

This allows you to specify a "window" defined by measuring a point at the top right and bottom left corners. If you press the search button, the search limits will be relative to the direction the instrument is currently pointing. In other words if your **search window ranges** are 30° horizontal and 30° vertical, it will apply this to your current direction. So the search will be limited to an area 15° left, right, up and down from your current direction.

Absolute Window

This allows you to specify an absolute search "center" for your search window. This forces FieldGenius to search in an absolute area defined by the angles set in the **search window center** fields. Furthermore, the search window range parameters apply to the search window center. For example, let's assume you defined 180° as the horizontal search window center, and the horizontal search window range is 30°. Your instrument will be forced to search in an area 15° left and right of the 180° plate reading. So if your prism is situated at a circle reading of 210°, it would never find you as the instrument would never go past a circle reading of 195° (180+15) when searching.

RC-2 Fast Track

If you're using a Topcon instrument, you can set the search mode to RC-2. This will force the instrument to use the RC-2 system for the search.

PS Next

This setting will appear if your Leica instrument has the power search system. Using this setting with FieldGenius onboard will operate the new directional Power Search function relative to the prism. Pressing the PS button on the right side will force the instrument to start its search turning to the right. If FieldGenius is being operated via a Data Collector and this setting is used the functions will be relative to the Instrument. So pressing the PS button on the right side will force the instrument to turn to the left.

PS Next (Reversed)

This setting will appear if your Leica instrument has the power search system. Settings it to this will reverse the behaviour of the Power Search directional function. If FieldGenius is being operated onboard then pressing the PS right will turn the instrument left and opposite if FieldGenius is being operated on a data collector.

PS Absolute Window

This setting will appear if your Leica instrument has the power search system. This will force the power search system to do a relative search based on the **search window range**.

RC-PR

If you're using a Sokkia SRX, you can set the search mode to RC-PR. This will force the instrument to use the RC system for the search.

Search Window Range

Use this to define the upper right corner and lower left corner of your search window. Pressing the measure button will step you through the procedure and it will calculate the horizontal and vertical search range. This range will be applied to the instrument's current direction when the user presses the search button.

Search Window Center

Use this to set an absolute center for your search window. The search window range parameters will be applied to the search window values that were measured. Pressing the measure button will step you through the procedure and it will calculate the horizontal and vertical search range.

Auto search for prism

If this is checked, then if your instrument has lost its lock on the prism, FieldGenius will automatically initiate a search for the prism when the measure button is pressed. You will see the word "Search" on the lock button at the top of the [robotic instrument toolbar](#) while a search is in progress.

Conventional Total Station

When connecting to a conventional total station there are a few things you need to confirm before connecting to FieldGenius.

You need to know what the communication parameters are set to on the instrument. Please take the time to find what the following settings are set to on the instrument: Baud Rate, Data Bits, Stop Bits and Parity.

Because of all the different instruments available, we cannot provide help on retrieving these settings from your instrument. Please refer to your owner's manual or contact technical support from your equipment manufacturer.

Total Station Profile

Once you know the settings, you can connect FieldGenius to the instrument. If you just installed FieldGenius you can start the program and follow the prompts until you get to the [Instrument Selection](#) screen. From there, select **Total Station** as the Instrument Type, and then press the **Add** button to create a new Instrument Profile. Name the profile for your instrument, and then press the **Edit** button to access the [Total Station Configuration](#) screen to configure your profile. From there choose the **Model and Communication** button to configure FieldGenius.

You can also access this screen by going to **Main Menu | Connect | Instrument Selection** and choose total station.

Select Make and Model

FieldGenius uses a smart driver that will poll the instrument to see what commands it supports. Because of this you will see that in the Model section we don't list every instrument built by the manufacturer. If you're unsure of what make and model to choose visit our website and use the [online help-desk support center](#) to do a search for your instrument.

Communication Settings

Confirm the settings so they match the settings from your instrument. If you don't know what the settings on the instrument are, you can always try the **Default Comm Settings** button.

Other Settings

On the [Total Station Configuration](#) screen, you can review the other options to set some additional parameters for your instrument.

Connect to Instrument

If you're not connected to the instrument you will see a status of "**Not Connected**" displayed above the Connect to Instrument button. When you're ready to connect make sure you have done the following:

1. Powered on the instrument
2. Levelled the instrument
3. Compensated the instrument.
4. Connected the data cable from the instrument to your data collector.

Once you have done all four steps, you can press the **Connect to Instrument** button. If you see a status of "**Connected**" displayed above the Connect to Instrument button then you have successfully connected.

Getting Started

To start taking measurement you need to exit out the Total Station Configuration screen by pressing close button. Depending on the instrument you connected to you will have different options available. Please review the [Instrument Toolbar](#) topic for more information.

Tip: You can use the enter key on your device to take a measurement. For example, if your Measure Mode is set to Sideshot and you press the enter key, your instrument will take a measurement.

Robotic Total Station

When connecting to a robotic total station there are a few things you need to confirm before connecting to FieldGenius.

You need to know what the communication parameters are set to on the instrument. Please take the time to find what the following settings are set to on the instrument: Baud Rate, Data Bits, Stop Bits and Parity.

Because of all the different instruments available, we cannot provide help on retrieving these settings from your instrument. Please refer to your owner's manual or contact technical support from your equipment manufacturer.

Create Total Station Profile

Once you know the settings, you can connect FieldGenius to the instrument. If you just installed FieldGenius you can start the program and follow the prompts until you get to the [Instrument Selection](#) screen. From there, select **Total Station** as the Instrument Type, and then press the **Add** button to create a new Instrument Profile. Name the profile for your instrument, and then press the **Edit** button to access the [Total Station Configuration](#) screen to configure your profile. From there choose the **Model and Communication** button to configure FieldGenius.

You can also access this screen by going to **Main Menu | Connect | Instrument Selection** and choose total station.

Select Make and Model

FieldGenius uses a smart driver that will poll the instrument to see what commands it supports. Because of this you will see that in the Model section we don't list every instrument built by the manufacturer. If you're unsure of what model and make to choose visit our website and use the [online help-desk support center](#) to do a search for your instrument.

Communication Settings

FieldGenius has updated its Bluetooth connection process to save all previously connected devices in a convenient pull down list. To connect to a Bluetooth device from the Instrument Selection screen choose the type of device you wanting to connect to and Click "Add" button. This will prompt the user to give the device a unique name and then proceed to the Instrument Profile screen. Now click on the "Model and Communication" button to take you to the next screen where it will prompt the user for the make and model of the device you wish to connect to. Press the "Bluetooth Device List" button to take you to the BT device List screen where you can Search for, Edit or Delete a device.

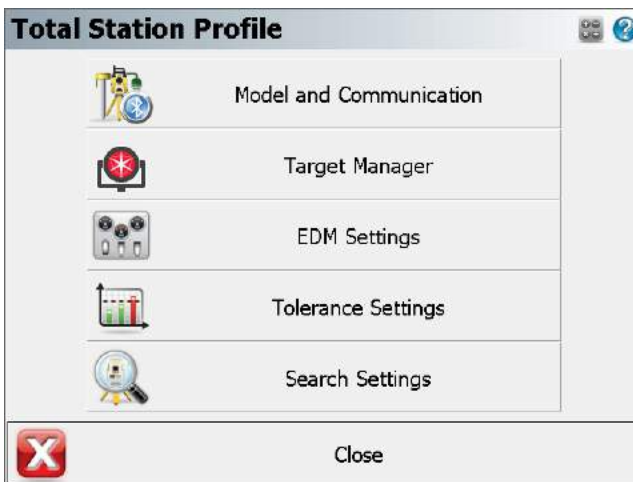

Model and Communication

Make Model

Status: **Not Connected**

Port

Device

Bluetooth Device List

Name	Bluetooth ID	PIN
RH_1625194	RH_1625194	0000

Other Settings

On the [Total Station Configuration](#) screen, you can review the other options to set some additional parameters for your instrument.

Connect to Instrument

If you're not connected to the instrument you will see a status of "**Not Connected**" displayed above the Connect to Instrument button. When you're ready to connect make sure you have done the following:

1. Powered on the instrument and radios
2. Leveled the instrument
3. Compensated the instrument
4. Connected the data cable from the instrument to one radio, and your data collector to the other radio

Once you have done all four steps, you can press the **Connect to Instrument** button. If you see a status of "**Connected**" displayed above the Connect to Instrument button then you have successfully connected.

Getting Started

To start taking measurement you need to exit out the Total Station Configuration screen by pressing the Connect button. Depending on the instrument you connected to you will have different options available. Please review the [Robotic Instrument Toolbar](#) topic for more information.

No Communication

When trying to communicate with your instrument you will see sometimes see a "*No communication with instrument. Check settings, cables and power.*" error message if FieldGenius can't make a connection with your instrument.

Usually this happens when your communication parameters are not the same on the instrument and in FieldGenius. You need to check these settings again to make sure they're correct.

This can also happen if you have a bad cable. If you're using a robotic instrument you might have setup your radios incorrectly.

Total Station Settings

[Total Station Toolbar | Instrument Settings](#)

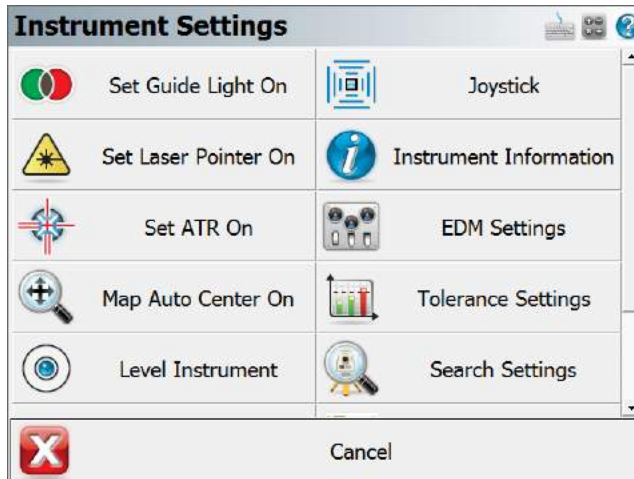

Use the vertical scroll bar along the side to access additional instrument settings if they cannot all fit on screen at the same time.

Please note that not every instrument supports each of the following functions, so you may not see all of the following buttons when connected to your total station.

Level Instrument

This will open the [Check Level](#) screen, where you can check how level your instrument is.

Instrument Information

When this is pressed, we will display the current battery status of your instrument. Note, not all instruments support this.

EDM Settings

Use this to set the EDM mode for your instrument. Every manufacturer has different measurement modes available but we will list only those that your instrument supports. Please refer to your instrument manual for more information on the EDM modes your instrument supports. Any time you change your EDM Mode, FieldGenius writes a comment into the raw file indicating which mode is being used.

Tolerance settings

This will take you to you [measurement tolerance settings](#).

Set Angle

Use this to open the [Set Angle](#) screen where you can view the current angles and turn or flop your motorized instrument.

[Auto-Center On / Off](#)

Use this to automatically center the map when a point is shot. If turned on, whenever you take a measurement, the current prism location will always appear in the center of your map display.

[ATR On / Off](#)

Use this to turn on and off your instruments Auto Target Recognition feature. When ATR is turned on the measure button on the Instrument Toolbar will have "ATR" with the Icon on the button.

[Laser Pointer On / Off](#)

This turns on and off the instrument's red laser pointer.

[Guide Lights On / Off](#)

This will turn on and off your instrument's guide lights.

[Rotate Instrument](#)

This will allow you to set the horizontal and vertical ranges for the instrument search. You can set the instrument to Move Absolute, Mover Relative, Turn+90, Turn -90 and Flip Scope.

[Basic Measure](#)

This will bring up the Basic Measure screen and allow you to measure an angle and distance .

[Enable Auto-Location](#)

This will turn on the mechanical, electrical, plumbing functionality. See Measurement Mode AutoLayout sections for [Point on Wall](#) , [Point on Floor](#), and [Pipe through wall](#).

[Instrument Joystick](#)

This is the Total Station Joystick function. When activated you will be able to move your motorized instrument to the left, right, up and down by using the joystick touch-screen. There are three speeds that can be activated: slow, medium, and fast. The smaller inside blue buttons activate the slowest turn mode, and the larger outside blue buttons activate the fastest turn mode. To stop the instrument from turning, simply press the red Stop button at the center. **The directions assume you are at the pole looking at the instrument.** Pressing the right buttons will turn the instrument to your right, pressing the up buttons will turn the scope up, etc.

[Instrument Connect / Disconnect](#)

Use this to connect or disconnect FieldGenius from the instrument. When you are connected to the instrument you will see the Disconnect Instrument button.

Rotate Instrument

[Total Station Toolbar](#) | [Instrument Settings](#) | [Rotate Instrument](#)

You can access this screen by pressing the **Rotate Instrument** button on the [Total Station Settings](#) screen.

The screenshot shows a software interface titled "Set Angle". At the top left, the title "Set Angle" is displayed. Below the title are two input fields: "Horz Angle" and "Vert Angle". Underneath these fields are five buttons: "Move Absolute", "Move Relative", "Turn +90°", "Turn -90°", and "Flip Scope". At the bottom left is a red square button with a white "X", and at the bottom right is a "Close" button. The interface is clean and functional, typical of a handheld device's software.

Horizontal and Vertical Angles

Use these two fields to enter in angles that will be used by the Set Angle buttons.

Move Absolute

Use this to turn the instrument to a plate reading that you've entered in the HA or VA fields. For example if you enter 45°30'30" for the HA and 90°10'00" for the VA, pressing the Absolute button will turn your instrument so the plate reading equals these values.

Move Relative

Use this to turn an angle to the right or left of the current instrument plate reading. Positive values will be added to the current plate reading, negative values will be subtracted. Enter your values in the HA and VA fields.

Turn +90°

Pressing this will force your instrument to turn 90 degrees to the right.

Turn -90°

Pressing this will force your instrument to turn 90 degrees to the left.

Flip Scope

This will plunge the scope and reverse the direction for you.

Check Level

Total Station Toolbar | Settings | Level Instrument

If your instrument supports it, you can check to see how level your instrument is.

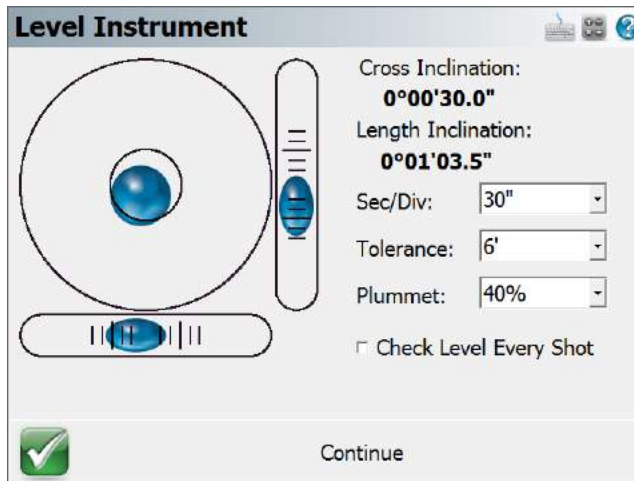

Plummet Intensity

If your instrument has a laser plummet or laser pointer, FieldGenius can toggle those functions on or off. On some models of total station this feature is turned on automatically.

Division

You can now adjust the sensitivity of your display to show 20, 30, and 60 second intervals.

Tolerance

You can now set a tolerance for the level bubble sensor. If you exceed that tolerance then you will receive a warning message that indicates your instrument is out of level. You can also set the tolerance level to OFF, which basically turns off the tilt compensator on the instrument. Please note that turning the compensator off can greatly affect the quality of the data surveyed.

Check Level Every Shot



Use this option to force our software to check instrument level before every measurement. The default is off.

Basic Measure

[Total Station Toolbar](#) | [Instrument Settings](#) | [Basic Measure](#)

[Total Station Onboard](#)

The Basic Measure mode is a quick way for the user to setup and take a quick measurement without having a Project or a total station setup and provides a direct view of the angular and distance values. However using this mode will not allow the observation to be stored to the database or RAW file.

Basic Measure	
Horizontal Angle: 70°41'56"	Horizontal Distance: 2.794m
Vertical Angle: 94°45'03"	Vertical Distance: -0.232m
	Slope Distance: 2.804m
Plate Angle: <input type="text" value="0°00'00"/>	<input type="button" value="Apply"/>  Set Laser Pointer On
<input checked="" type="checkbox"/> OK	 Target Manager  Measure

Options

Plate Angle

Users can define a desired plate angle to be applied to the current orientation.

Set Laser Pointer

Toggles Laser Pointer ON/OFF

Target Manager

Target Manager allows the users to toggle between Prisms and EDM modes.

Note: Basic Measure mode does not take Target Height into consideration.

Measure

Initiates an observation from the Total Station.

OK

Pressing this button with FieldGenius onboard Total Station will take the user to the Project Manager.

Target Manager

Total Station Toolbar | Target Manager

The Target Manager is a place where you can manage your EDM (electronic distance measurement) targets. You can create, edit, copy, and delete targets.

The Target Manager is divided into 2 sections: Backsight and Foresight.

Note: Leica users should refer to the [Leica version of the Target Manager topic](#).

Target Manager: Backsight

Use the Backsight screen to define your backsight target and enter a backsight target height.

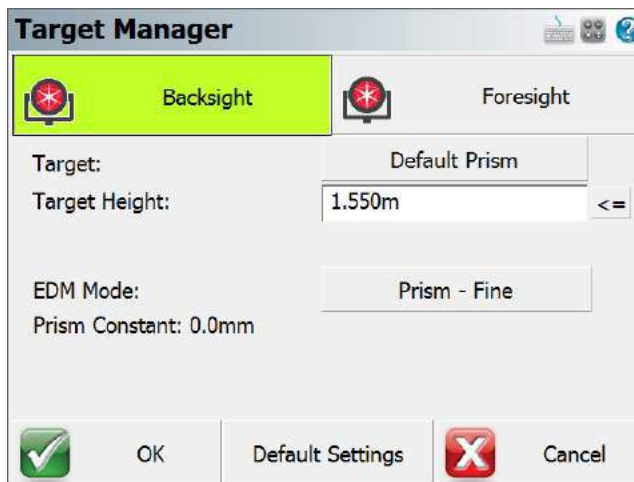

Target

Press this button to select a backsight target from the Prism Selection window.

Target Height

Enter the height of your target here.



Press the **Set Default Height** button to assign the default height to this **Target Height** field. The default height is defined in the [Default Settings](#) screen.

EDM Mode

Use this field to select the EDM Mode you would like to use. You will only be able to select an EDM mode that corresponds to your target type.

Prism Constant

This field will display whatever prism constant that you entered for the selected target.

OK

This records the settings you have just made, closes the Target Manager, and returns you to the MapView.

Target List

Press this button to access the [Target List](#). The Target List consists of user-defined and default instrument targets. Here you can create, copy, edit, and delete targets.

Default Settings

Press this button to access the [Default Settings](#) screen. This is where you define the default target heights.

Cancel

Press this button to discard any changes made to the Backsight dialog and returns you to the MapView.

Target Manager: Foresight

Use the Foresight screen to select the foresight target and enter a target height.

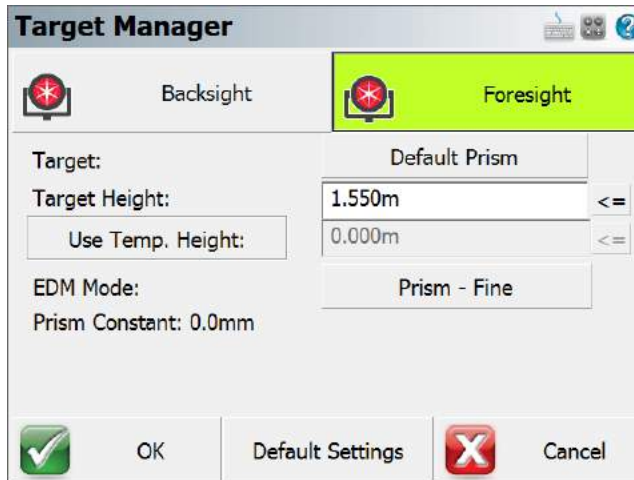

Target

Press this button to select a foresight target from the Prism Selection window.

Target Height

Enter the height of your foresight target here.



Press the **Set Default Height** button to assign the default target height to this **Target Height** field. The default height is defined in the [Default Settings](#) screen.

EDM Mode

Use this field to select the EDM Mode you would like to use. Typically you will want to select an EDM Mode that corresponds to your target type.

Use Temp. Height

Press this button to activate the Temporary Height function (button is active in the above image). To enable the temporary height be used, you must press the **Use Temp. Height** button. Once activated, the following measurement will use this temporary height but it will be a one-time measurement, and then the system will immediately revert back to the height defined in the **Target Height** field. This is handy if you need to take a quick shot using a different height such as when measuring an invert.



Press the **Set Default Height** button to assign the default Temporary height to this **Target Height** field. The default height is defined in the [Default Settings](#) screen

Prism Constant

This field will display whatever prism offset that you entered for the selected target.

OK

This records the settings you have just made, closes the Target Manager, and returns you to the MapView.

Cancel

Press this button to discard any changes made to the Backsight dialog and returns you to the MapView.

Prism Selection Window

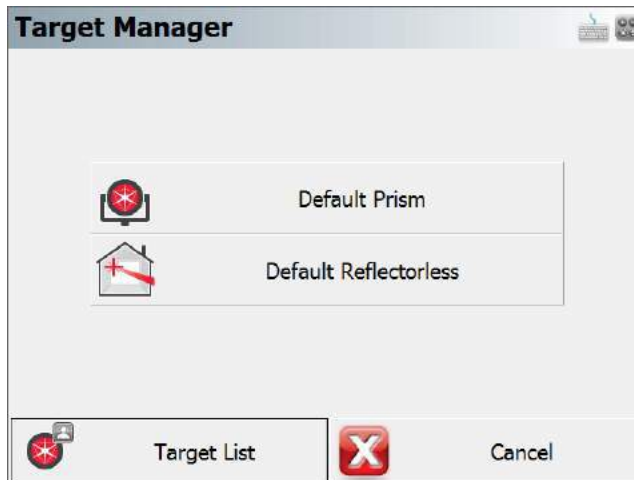

Press the button labelled with the desired prism to use to set it as the Prism for either the backsight or foresight.

Target List

Press this button to access the [Target List](#). Here you can create, copy, edit, and delete targets.

Cancel

Press this button to go back to the Target Manager window.

Target List

Total Station Toolbar | Target Manager | Target List

The Target List is where you can create, edit, copy, and delete targets. The Target List comes with 2 default targets (Default Prism and Default Reflectorless) but you can create as many more as you like. All targets are saved in the Settings.xml file and is located in the Programs folder.

[Click here for help with Leica Targets](#)

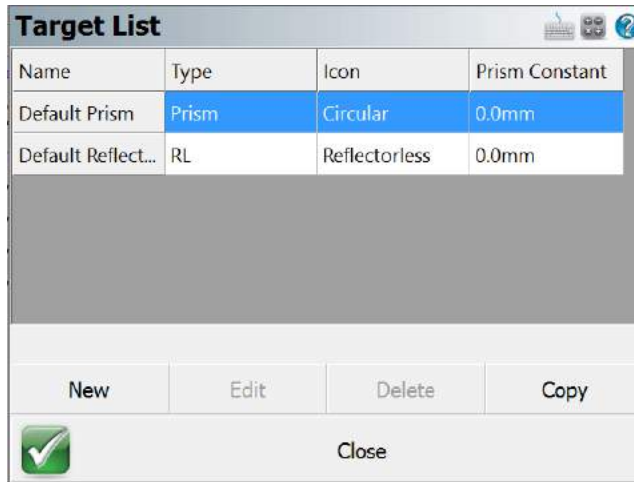

You are not permitted to delete or edit a default target but you certainly can copy one and edit the copy.

New

Tap on this button to access the [New Target](#) dialog. Here you can create a new target.

Edit

Tap on a target to select it. Then press the **Edit** button to access the [Edit Target](#) dialog. Default targets cannot be edited.

Delete

Tap on a target to select it. Then press the **Delete** button to delete the selected target. You will receive a warning message that you must acknowledge before deletion is complete. Default targets cannot be deleted.

Copy

Tap on a target to select it. Then press the **Copy** button. This will open the [Edit Target](#) dialog and you can then edit the copied parameters.

Close

Pressing this button returns you to the Target Manager screen.

New Target

[Total Station Toolbar](#) | [Target Manager](#) | [Target List](#) | [New](#)

Use this option to create a new target. Provide the new target with a unique name, a prism constant, and select an icon to represent your new target.

[Click here for help creating a new Leica Geosystems target.](#)

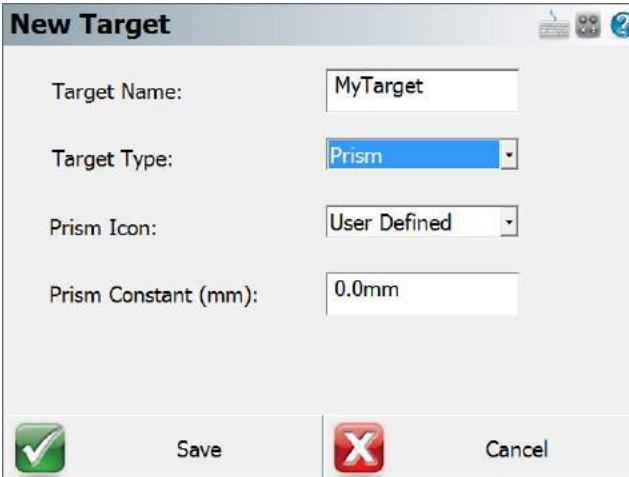

New Target

Target Name: MyTarget

Target Type: Prism

Prism Icon: User Defined

Prism Constant (mm): 0.0mm

Save Cancel

Target Name

Use this field to either edit or enter a new name for the target you are editing.

Target Type

There are two target types available to select. **Prism** is to be used when you are selecting a target that has a known offset. This can be a round prism, 360, mini, etc. **RL** stands for reflectorless and you should select this target type if you are using an instrument that is reflectorless capable and you do not wish to use a designated reflector.

Prism Icon

Use this field to select an icon for your new target.

Prism Constant

This defines the relation of the distance measurement to the mechanical reference point of the reflector. Your prism will have a published prism constant (also called and offset).

Save

Press this button to store your new changes to the Settings.xml file, and return you to the [Target List](#) screen.

Cancel

Press this button to cancel creating a new target. You will be returned to the [Target List](#) screen.

Edit Target

[Total Station Toolbar](#) | [Target Manager](#) | [Target List](#) | [Edit](#)

Use this option to edit an existing target. You will also see this display after you copy an existing target.

[Click here for help on editing a Leica Geosystems target.](#)

Edit Target

Target Name: MyTarget

Target Type: Prism

Prism Icon: User Defined

Prism Constant (mm): 0.0mm

Save Cancel

Target Name

Use this field to either edit or enter a new name for the target you are editing.

Target Type

There are two target types available to select. **Prism** is to be used when you are selecting a target that has a known offset. This can be a round prism, 360, mini, etc. **RL** stands for reflectorless and you should select this target type if you are using an instrument that is reflectorless capable and you do not wish to use a designated reflector.

Prism Icon

Use this field to select an icon for your new target.

Prism Constant (mm)

This defines the relation of the distance measurement to the mechanical reference point of the reflector. Your prism will have a published offset.

Save

Press this button to store your new changes to the Settings.xml file, and return you to the [Target List](#) screen.

Cancel

Press this button to cancel creating a new target. You will be returned to the [Target List](#) screen.

Default Settings

[Total Station Toolbar](#) | [Target Manager](#) | [Default Settings](#)

The Default Settings screen is where you can define the default target heights for prism targets, RL (reflectorless) targets, and a temporary height. The temporary height value is used for taking a one-time measurement using the height value entered in this field. After the measurement is completed, the system will revert back to using the current target height.

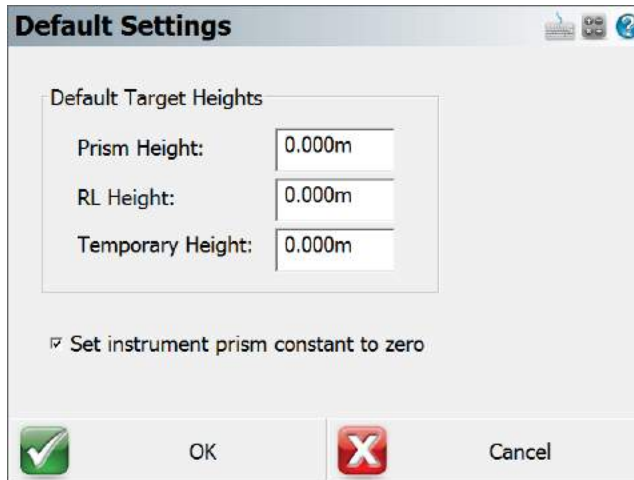

Default Settings

Default Target Heights

Prism Height: 0.000m

RL Height: 0.000m

Temporary Height: 0.000m

Set instrument prism constant to zero

OK Cancel

Prism Height

Enter your most common prism height into this field. When you press the **Use Default Height** button in the [Target Manager](#) screen, this value will populate the **Target Height** field. This is convenient when you have a standard prism height and want to assign it quickly.

Important Note: You must be in a prism measure mode to be able to use the **Default Height** button in the [Target Manager](#) screen and have it use a default prism height.

RL Height

Enter your most common ReflectorLess (RL) height into this field. When you press the **Use Default Height** button in the [Target Manager](#) screen, this value will populate the **Target Height** field with this default height.

Important Note: You must be using a reflectorless measure mode to populate this field using the **Default Height** button in the Target Manager screen, and have it use the default reflectorless height.

Temporary Height

The temporary height function works as a one-time measurement using the height entered into this field. After the measurement has completed, the target height will revert back to the height that had been defined in the **Target Height** field. This is very handy when you want to take a quick one-time measurement such as for when measuring an invert.

Set instrument prism constant to zero

If this has a check mark in the box, a prism constant of zero will be uploaded to your instrument. The offsets specified in the foresight and backsight targets will be applied to the measurements when received by FieldGenius. Remove the check mark if you don't want FieldGenius to modify your instrument's prism offset. **Not all instruments support this feature.**

When you connect your instrument to FieldGenius, special notes are recorded in the raw file regarding prism offsets.

If you have the "Set Instrument" toggle turned on and your instrument supports this feature, FieldGenius will set your instrument's prism offset to zero so no correction will be applied to the measurement. Then once FieldGenius receives this uncorrected measurement, it will use the values you specified in the prism offset fields and adjust the distance accordingly. For example, if you specified an offset of 30mm, FieldGenius will upload an offset of zero to your instrument and apply the 30 mm offset to the measurement after it is received. In your raw file you will see the following note:

```
| --FieldGenius Prism: 30mm Instrument Prism: 0mm |
```

Most prism offset are specified in millimeters. FieldGenius will make the necessary conversions so the proper adjustment is applied.

If FieldGenius can't set the prism offset on your instrument, it usually can't read it either. Since a prism offset wasn't uploaded, we don't know what prism offset is set on the instrument. So we indicate this by writing to the raw file that the instrument prism offset is "unknown".

```
| --FieldGenius Prism: 30mm Instrument Prism: Unknown |
```

When this happens you will usually want to confirm what offset are currently configured on your instrument in regards to prism offsets.

Special Notes:

- When using instruments that don't support uploading of prism constants, be sure not to double up your prism offsets by applying it in the instrument and FieldGenius at the same time.
- Since prism offsets are so important, on the measurement progress meter you will see what offset is being applied to your measurement.

OK

Pressing this button will save your changes in this dialog, and return you to the [Target Manager](#).

Cancel

Pressing this button will ignore your changes in this dialog and return you to the [Target Manager](#).

Target Manager: Leica Instruments

Total Station Toolbar | Target Manager

The Target Manager is a place where you can manage your EDM (electronic distance measurement) targets. You can create, edit, copy, and delete targets. Leica Geosystems uses a different method for determining prism offsets as they have a value called a *Leica Constant*. See the help on the [New](#) or [Edit Target](#) screens for information on how to calculate a Leica Constant.

The Target Manager is divided into 2 sections: Backsight and Foresight.

Target Manager: Backsight

Use the Backsight screen to define your backsight target, choose a measure mode, and enter a backsight target height. Tap on the Backsight tab at the top of the screen to access the Backsight section

The screenshot shows the 'Target Manager' interface with the 'Backsight' tab selected. The 'Target' is set to 'Leica Round Prism', the 'Target Height' is '1.300m', the 'EDM Mode' is 'IR Standard', and the 'Leica Constant' is '0.0mm'. The 'OK' button is highlighted with a green checkmark icon.

Target

Use this field to select a backsight target from the [Target List](#).

Target Height

Enter the height of your target here.



Press the **Set Default Height** button to assign the default Target height to this **Target Height** field. The default height is defined in the [Default Settings](#) screen.

EDM Mode

Use this field to select the EDM mode you would like to use. Typically you will want to select an EDM mode that corresponds to your target type.

Leica Constant

This field will display the Leica constant associated with your target. See the [New](#) or [Edit Target](#) Help for an explanation of how to compute a Leica constant. This will be especially important if you are using a non-Leica target.

OK

This records the settings you have just made, closes the [Target Manager](#), and returns you to the MapView.

Target List

Press this button to access the [Target List](#). Here you can create, copy, edit, and delete targets.

Cancel

Press this button to discard any changes made to the Backsight dialog and returns you to the MapView.

Target Manager: Foresight

Use the Foresight screen to select the foresight target, choose a measure mode, and enter a target height. You also have the option of using a temporary target height. Tap on the Foresight tab at the top of the screen to access the Foresight section.

The screenshot shows the 'Target Manager' dialog box with the 'Foresight' tab selected. The dialog is divided into two sections: 'Backsight' (grey) and 'Foresight' (green). The 'Foresight' section contains the following fields and controls:

- Target:** Leica Round Prism
- Target Height:** 1.300m (with a '< =' button to the right)
- Use Temp. Height:** 0.000m (with a '< =' button to the right)
- EDM Mode:** IR Standard
- Leica Constant:** 0.0mm

At the bottom of the dialog, there are three buttons: 'OK' (with a green checkmark icon), 'Default Settings', and 'Cancel' (with a red 'X' icon).

Target

Use this field to select a foresight target.

Target Height

Enter the height of your foresight target here.



Press the **Set Default Height** button to assign the default height to this **Target Height** field. The default height is defined in the [Default Settings](#) screen.

Use Temp. Height

Press this button to activate the Temporary Height function (button is active in the above image). To enable the temporary height be used, you must press the **Use Temp. Height** button. Once activated, the following measurement will use this temporary height but it will be a one-time measurement, and then the system will immediately revert back to the height defined in the **Target Height** field. This is handy if you need to take a quick shot using a different height such as when measuring an invert.



Press the **Set Default Height** button to assign the default height to this **Target Height** field. The default height is defined in the [Default Settings](#) screen.

EDM Mode

Use this field to select the EDM Mode you would like to use. Typically you will want to select an EDM Mode that corresponds to your target type.

Leica Constant

This field will display the Leica constant associated with your target. See the [New](#) or [Edit Target](#) Help for an explanation of how to compute a Leica constant. This will be especially important if you are using a non-Leica target.

OK

This records the settings you have just made, closes the Target Manager, and returns you to the MapView.

Target List

Press this button to access the [Target List](#). Here you can create, copy, edit, and delete targets.

Cancel

Press this button to discard any changed made to the Backsight dialog and returns you to the MapView.



Press the button labelled with the desired prism to use to set it as the Prism for either the backsight or foresight.

Target List

Press this button to access the [Target List](#). Here you can create, copy, edit, and delete targets.

Cancel

Press this button to go back to the Target Manager window.

Target List: Leica

[Total Station Toolbar](#) | [Target Manager](#) | [Target List](#)

The Target List is where user-defined and default Leica targets are kept. The Target List is where you can create, edit, copy, and delete targets. The Leica instruments Target List comes with 9 default Leica targets. You cannot edit or delete a default Leica target but you can copy a default target and edit the copy. All targets are saved in the Settings.xml file, and is located in the Programs folder.

Name	Type	Icon	Leica Const..	Absolute C..
Leica Roun...	Prism	Circular	0.0mm	-34.4mm
Leica 360 P...	Prism	360	23.1mm	-11.3mm
Leica Mini ...	Prism	Mini Zero	0.0mm	-34.4mm
Leica Mini ...	Prism	Mini	17.5mm	-16.9mm
Leica Mini ...	Prism	360 Mini	30.0mm	-4.4mm
A400133	Prism	A400133	30.1mm	6.2mm

You are not permitted to delete or edit a default target but you certainly can copy one and edit the copy.

New

Tap on this button to access the [New Target](#) dialog. Here you can create a new target.

Edit

Tap on a target to select it. Then press the **Edit** button to access the [Edit Target](#) dialog. Default targets cannot be edited.

Delete

Tap on a target to select it. Then press the **Delete** button to delete the selected target. You will receive a warning message that you must acknowledge before deletion is complete. Default targets cannot be deleted.

Copy

Tap on a target to select it. Then press the **Copy** button. This will open the [Edit Target](#) dialog and you can then edit the copied parameters.

Close

Pressing this button returns you to the Target Manager screen.

New Target: Leica

Total Station Toolbar | Target Manager | Target List | New

Use this option to create a new target for your Leica Geosystems instrument. Provide the new target with a unique name, define the target type, and enter the Leica constant. Leica uses a different prism offset method than other manufacturers and you should familiarized yourself with how they are computed. See the **Leica Constant** section below for more information.

Target Name

Use this field to either edit or enter a new name for the target you are creating.

Target Type

There are two target types available to select. **Prism** is to be used when you are selecting a target that has a known offset. This can be a round prism, 360, mini, etc. **RL** stands for reflectorless and you should select this target type if you are using an instrument that is reflectorless capable and you do not wish to use a designated reflector.

Prism Icon

The mandatory icon for any new Leica target must have the **User Defined** prism icon. This is a Leica instrument requirement and therefore cannot be changed.

Leica Constant (mm)

Leica prism constants differ from non-Leica prism constants. In summary, Leica's prism constant of 0mm is equal to -34.4mm absolute prism constant relative to the plumb line. A simple formula to explain the relationship:

Leica Constant (for non-Leica prisms) = Absolute Constant + 34.4mm, or

Absolute Constant (for Leica prisms) = Leica Constant – 34.4mm

Examples:

1. SECO -30mm offset prism
 - a. Leica Constant = $-30\text{mm} + 34.4\text{mm} = 4.4\text{mm}$
 - b. Absolute Constant = -30mm
2. SECO 0mm offset prism
 - a. Leica Constant = $0\text{mm} + 34.4\text{mm} = 34.4\text{mm}$
 - b. Absolute Constant = 0mm
3. Leica GPR1 round prism
 - a. Absolute Constant = $0\text{mm} - 34.4\text{mm} = -34.4\text{mm}$
 - b. Leica Constant = 0mm
4. Leica GRZ4 360° prism
 - a. Absolute Constant = $23.1\text{mm} - 34.4\text{mm} = -11.3\text{mm}$
 - b. Leica Constant = 23.1mm

It is strongly recommended that you test your use of prism constants on a known baseline to be sure that your non-Leica prism is in the true zero prism system.

Absolute Constant (mm)

This defines the relation of the distance measurement to the mechanical reference point of the reflector. Use the formula in the **Leica Constant** section above to calculate the Leica constant. Enter that value in the **Leica Constant** field and see the Absolute constant be automatically computed for you.

Save

Press this button to store your new changes to the Settings.xml file, and return you to the Target List screen.

Cancel

Press this button to cancel creating a new target. You will be returned to the Target List screen.

Edit Target: Leica

Total Station Toolbar | Target Manager | Target List | Edit

Use this option to edit an existing user-defined target or edit a copy of a Leica instrument target. You will also see this display after you copy an existing target. Leica uses a different prism offset method than other manufacturers and you should familiarized yourself with how they are computed. See the *Leica Constant* section below for more information.

Target Name

Use this field to either edit or enter a new and unique name for the target you are editing.

Target Type

There are two target types available. **Prism** is to be used when you are selecting a target that has a known offset or prism constant. This can be a round prism, 360, mini, etc. **RL** stands for reflectorless and you should select this target type if you are using an instrument that is reflectorless capable, and you do not wish to or cannot use a designated reflector.

Prism Icon

When creating Leica instrument targets, the prism icon must be **User Entered**, and that's why you are not permitted to edit the target's icon. This is a Leica instrument requirement and therefore cannot be changed.

Leica Constant (mm)

Leica prism constants differ from non-Leica prism constants. In summary, Leica's prism constant of 0mm is equal to -34.4mm absolute prism constant relative to the plumb line. A simple formula to explain the relationship:

Leica Constant (for non-Leica prisms) = Absolute Constant + 34.4mm, or

Absolute Constant (for Leica prisms) = Leica Constant – 34.4mm

Examples:

1. SECO -30mm offset prism
 - a. Leica Constant = $-30\text{mm} + 34.4\text{mm} = 4.4\text{mm}$
 - b. Absolute Constant = -30mm
2. SECO 0mm offset prism
 - a. Leica Constant = $0\text{mm} + 34.4\text{mm} = 34.4\text{mm}$
 - b. Absolute Constant = 0mm
3. Leica GPR1 round prism
 - a. Absolute Constant = $0\text{mm} - 34.4\text{mm} = -34.4\text{mm}$
 - b. Leica Constant = 0mm
4. Leica GRZ4 360° prism
 - a. Absolute Constant = $23.1\text{mm} - 34.4\text{mm} = -11.3\text{mm}$
 - b. Leica Constant = 23.1mm

It is strongly recommended that you test your use of prism constants on a known baseline to be sure that your non-Leica prism is in the true zero prism system.

Absolute Constant (mm)

The Absolute Constant or more commonly known as the Prism Constant defines the relation of the distance measurement to the mechanical reference point of the reflector. Use the formula in the **Leica Constant** section above to calculate the Leica constant. Enter that value in the **Leica Constant** field and see the Absolute constant be automatically computed for you.

Save

Press this button to store your target edits. Targets are stored to the Settings.xml file, and you are returned to the [Target List](#) screen.

Cancel

Press this button to cancel creating a new target. You will be returned to the [Target List](#) screen.

Default Settings: Leica

[Total Station Toolbar](#) | [Target Manager](#) | [Default Settings](#)

The Default Settings screen is where you can define the default target heights for prism targets, RL (reflectorless) targets, and a temporary height. The temporary height value is used for taking a one-time measurement using the height value entered in this field. After the measurement is completed, the system will revert back to using the current target height.

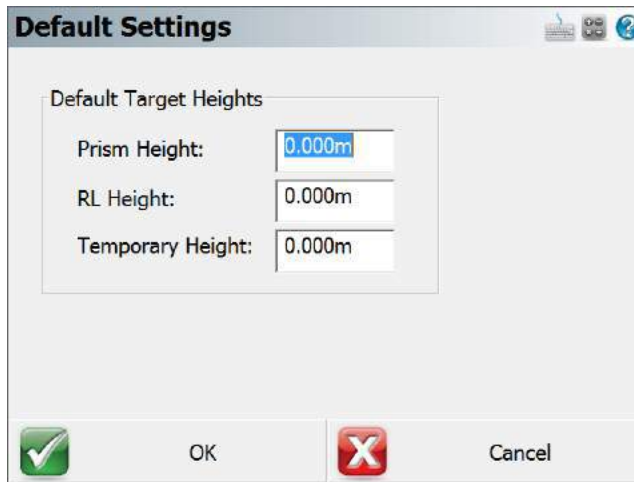

Default Settings

Default Target Heights

Prism Height: 0.000m

RL Height: 0.000m

Temporary Height: 0.000m

OK Cancel

Prism Height

Enter your most common prism height into this field. When you press the **Use Default Height** button in the Target Manager screen, this value will populate the **Target Height** field. This is convenient for when you have a standard prism height and want to assign it quickly.

Important Note: You must be in a prism measure mode to be able to use the **Default Height** button in the Target Manager screen and have it use a default prism height.

RL Height

Enter your most common ReflectorLess (RL) height into this field. When you press the **Use Default Height** button in the Target Manager screen, this value will populate the **Target Height** field with this default height.

Important Note: You must be using a reflectorless measure mode to populate this field using the **Default Height** button in the Target Manager screen, and have it use the default reflectorless height.

Temporary Height

The temporary height function works as a one-time measurement using the height entered into this field. After the measurement has completed, the target height will revert back to the height that had been defined in the **Target Height** field. This is very handy when you want to take a quick one-time measurement such as for when measuring an invert.

OK

Pressing this button will save your changes in this dialog, and return you to the Target Manager.

Cancel

Pressing this button will ignore your changes in this dialog and return you to the Target Manager.

Note: If you are wondering where the **Set Instrument Prism Constant to Zero** check box is, this is now done automatically when using Leica instruments.

GNSS REFERENCE

Create/Edit GNSS Profile

Select GNSS Profile

[Main Menu](#) | [Connect](#)

This is where you can create a new profile for each rover/base receiver you will be using.

There are two ways to get to this screen.

1. You can open the profile screen for your rover or base by going to [Main Menu](#) | [Settings](#) | [Instrument Selection](#). This will display the Instrument Selection screen which contains the GNSS Rover and GNSS Reference profiles.
2. If you already have your instrument type set to GNSS and you're currently in the map view, you can press the **Settings** button on the [GNSS toolbar](#). This will display the Instrument Selection screen which contains the GNSS Rover and GNSS Reference profiles.



Editing Profiles

On the Add Profile screen you can enter any name you wish for the profile. Profiles can be copied from one data collector to another, so you can have a "Master" profile file that is sent to all crews so they can quickly set up systems.

When you're ready to edit the settings for the profile you have selected, press the **Edit** button. This will display the GNSS configuration screen for the selected rover or reference profile.

Refer to the [GNSS Configuration \(Reference\)](#) or [GNSS Configuration \(Rover\)](#) topics for more information on the settings available for your profiles.

Your profiles are stored in the Settings.xml file within the ...\\MicroSurvey\\FieldGenius\\FG Projects\\ (Windows CE/Mobile) or ...\\Documents\\MicroSurvey\\FieldGenius\\FG Projects\\ (Windows Tablet/PC) directory so once you have configured one data collector, you can copy this file onto other data collectors to make the profiles available on them. This file should also be backed up for easy recovery.

Using Profiles for Connection

Once you've created your profiles, you can use them to connect to your receiver. Simply select the correct GNSS Mode, either GNSS Rover or GNSS Reference, then select the profile you want to use in the profile list.

When you've physically connected the data collector to your receiver, press the **Connect** button to start the connection process.

If it isn't successful you will see the following message "Could not detect GNSS receiver! Please check configuration, cable and power." You can then press the Auto Detect Baud Rate button to force FieldGenius to automatically try different baud rate settings. If this doesn't work you should review your profile settings and ensure that you have the correct COM port selected and that you have your data collector connected to the correct port on the GNSS receiver.

GNSS Reference Profile

[Main Menu](#) | [Connect](#) | [Edit Profile](#)

The GNSS Configuration for your reference unit is accessed from the [Instrument Selection](#) screen by selecting GNSS Reference as the Instrument Type, then pressing the **Edit** button to configure your selected GNSS Reference Profile.

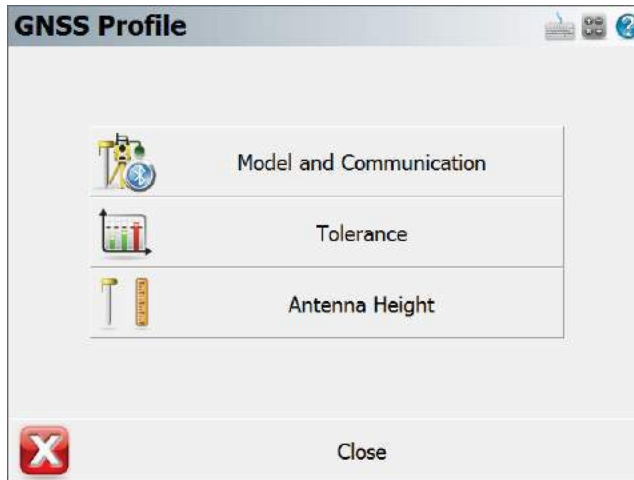

[Model and Communication](#)

This is used to select the Make and Model of receiver, the port that the data collector is connected to and the mode that the current receiver will play in the RTK process. Please see the [GNSS Model and Communication](#) topic for more information.

[Tolerance](#)

This is used to enter information about the location of the reference (base) station. Please see the [GNSS Tolerance \(Reference\)](#) topic for more information.

[Antenna Height](#)

The antenna settings are used to calculate or enter the height of the antenna phase center above the ground. Please see the [GNSS Antenna Configuration](#) topic for more information.

GNSS Rover Profile

[Main Menu](#) | [Connect](#) | [Edit Profile](#)

The GNSS Configuration for your rover unit is accessed from the [Instrument Selection](#) screen by selecting GNSS Rover as the Instrument Type, then pressing the **Edit** button to configure your selected GNSS Rover Profile.

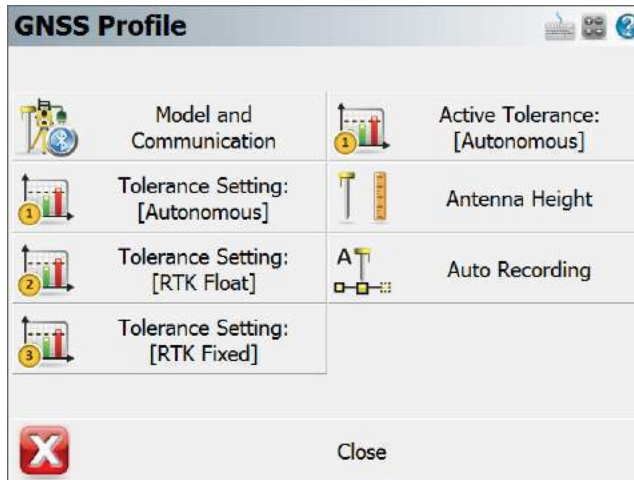

Model and Communication

This is used to select the Make and Model of receiver, and the port settings that the data collector will connect with. Please see the [GNSS Model and Communication](#) topic for more information.

Tolerance Setting: [Description] (x3)

The three configurable tolerance modes are used to enter information used in computing the position of the rover once a measurement has begun. Please see the [GNSS Tolerance Modes \(Rover\)](#) topic for more information.

Active Tolerance: [Description]

This displays the current tolerance mode, which can be changed at any time during your survey by selecting the [GNSS Settings](#) button in the [GNSS toolbar](#). Please see the [GNSS Tolerance Modes \(Rover\)](#) topic for more information

Antenna Height

The antenna settings are used to calculate or enter the height of the antenna phase center above the ground. Please see the [GNSS Antenna Configuration](#) topic for more information.

Auto Recording

The Auto Recording settings are used for collecting data in a "Kinematic" mode. The receiver can automatically log a point every X distance or Y seconds. The user simply selects what option they prefer to use for logging Kinematic data and start the survey. Keep in mind while collecting data at higher velocities that FieldGenius receives position updates from the GNSS at a maximum rate of once per second.

GNSS Model and Communication

[Main Menu](#) | [Connect](#) | [Edit Profile](#) | [Model and Communication](#)

The Model and Communication settings are used to select the Make and Model of receiver, the port that the data collector is connected to, and other communication parameters.

Cable Connection

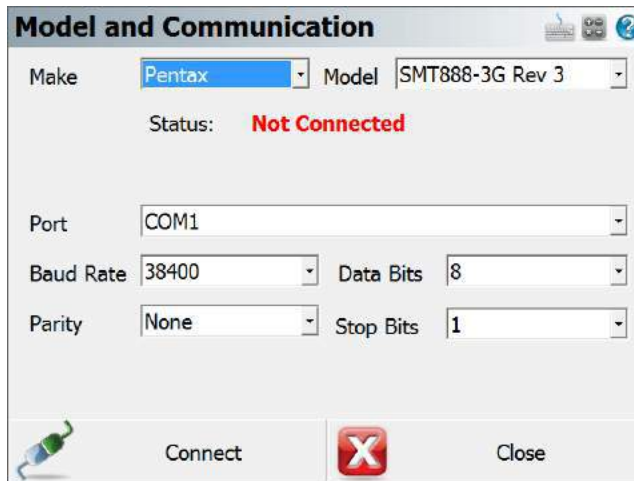

Model and Communication

Make: Pentax Model: SMT888-3G Rev 3

Status: **Not Connected**

Port: COM1

Baud Rate: 38400 Data Bits: 8

Parity: None Stop Bits: 1

Connect [X] Close

Model

Specify the make and model of receiver you are connecting to.

Sensor Port

If your receiver has more than one data port, specify the port on the receiver that the data collector will be connected to.

Port

Specify the port on your data collector (usually COM1) that you will connect a cable between your receiver and this port.

Baud Rate, Data Bits, Parity, Stop Bits

Specify the communication parameters for the serial connection. If you're unsure of what baud rate your receiver is set to you might want to set the baud rate to Auto Detect. This will force FieldGenius to check for communication using all the baud rate settings and if successful, it will set this baud rate in the profile.

Bluetooth Connection

Port

On many data collectors you can select Bluetooth as your communication port. If you select the Bluetooth port, the traditional serial communication options (Baud Rate, Data Bits, Stop Bits, Parity) will be replaced with a Bluetooth Search function.



Please note that not all Bluetooth-enabled devices will list Bluetooth as a Port option. In some cases you must configure and use a virtual COM port through Windows CE's internal Bluetooth Settings, for example COM6.

Bluetooth Search

If you set the port to Bluetooth, a **Bluetooth Search** button will appear. Press the search button to find the device you want to communicate wirelessly with. All devices within range will be listed, choose the one you want to use

The device you selected will be saved into your instrument profile for future use so you do not need to Search every time.

Bluetooth PIN

After initiating a Bluetooth connection, you will be prompted to enter the PIN (passkey) for the instrument you are connecting to. If your instrument does not need one just leave it blank and continue by pressing OK.

The PIN you enter will be encrypted and stored in your instrument profile.

GNSS Tolerance Settings (Reference)

[Main Menu](#) | [Connect](#) | [Edit Profile](#) | [Tolerance Settings](#)

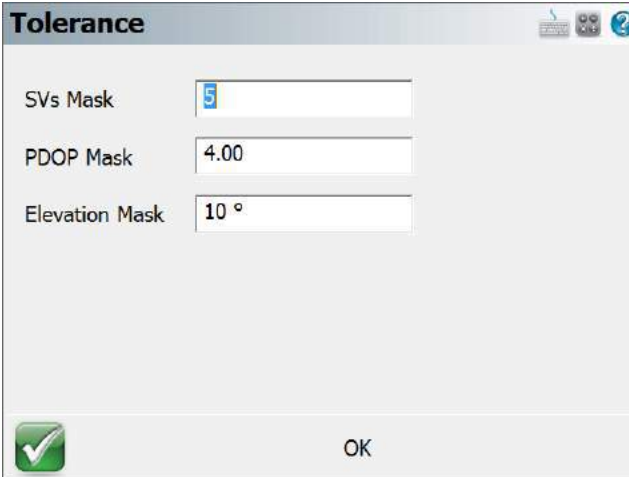

The screenshot shows a dialog box titled "Tolerance" with three input fields:

Setting	Value
SVs Mask	5
PDOP Mask	4.00
Elevation Mask	10 °

At the bottom left is a green checkmark icon, and at the bottom right is an "OK" button.

SVs Mask

The SVs Mask setting is used to establish the minimum number of satellites that are necessary to produce a solution with a valid position. The SVs must also pass the elevation mask test to be included in this number for the calculation of the rover position.

PDOP Mask

The PDOP mask is used to control the acceptable geometry of the satellites used to compute the RTK position. If the PDOP value exceeds this number, the user will not be eligible to collect an RTK position.

Elevation Mask

The Elevation Mask is used to determine which satellites to use in computing the differential corrections to broadcast to the rover(s). Satellites below this value will not be used in the solution. Elevation mask angles are typically equal or less than the elevation mask set for the rover system.

GNSS Tolerance Settings (Rover)

[Main Menu](#) | [Connect](#) | [Edit Profile](#) | [Tolerance Settings](#)

[GNSS Toolbar](#) | [Instrument Settings](#) | [Sensor Configure](#) | [Tolerance Settings](#)

The tolerances settings are used to enter information used in computing the position of the rover once a GNSS measurement has begun.

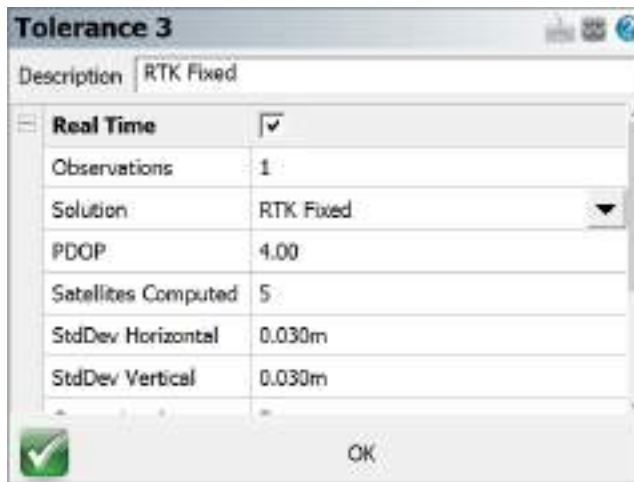

Tolerance 3	
Description	RTK Fixed
Real Time	<input checked="" type="checkbox"/>
Observations	1
Solution	RTK Fixed
PDOP	4.00
Satellites Computed	5
StdDev Horizontal	0.030m
StdDev Vertical	0.030m

You can define three different tolerance modes that can be selected from the Sensor Configure option in the [GNSS Settings](#) menu while surveying. Tolerance settings are used to ensure that certain criteria are being met every time you take a measurement. The reason for three different settings is to allow you to specify different tolerances for different types of measurements you might need to make. For example, control points would need to be measured more precisely than those used for topographic measurements.

Description

This is where you can assign a "friendly" description to your three tolerance modes to make them more easily identifiable to you - for example "Control Points" or "Topo Points".

Options

Real Time

Toggle to set the Tolerance Settings for RTK.

Observations

This is the minimum number of observations that the receiver must collect and average in order to compute a solution.

Solution

Each observation must be of the specified solution type (or better). You can select from several Solution modes depending on your receiver make and model, these can be:

- Autonomous
- SBAS (Satellite-based Augmentation System)
- DGPS (Differential Global Positioning System)
- RTK Float (Differential Carrier Solution)
- RTK Fixed (Differential Carrier Solution)

Please refer to your GNSS manufacturer's documentation for the solutions' respective positional accuracy.

Elevation Mask

The elevation mask is used to filter out satellites that are close to the horizon and are, thus, unreliable. Typical elevation mask angles can range between 10° and 20°.

PDOP

The PDOP (Position Dilution of Precision) mask is used to control the acceptable geometry of the satellites used to compute the solution. If the PDOP value exceeds this number, the user will not be eligible to collect a position. Typical PDOP masks are 5 or 6.

Satellites Computed

The Satellites mask is used to establish the minimum number of satellites that are necessary to produce a solution with a valid position. Each satellite must also pass the elevation mask test to be included in this number for the calculation of the rover position.

StdDev Horizontal

FieldGenius will use the instantaneous Standard Deviation values that your receiver is outputting to determine if the measurement can proceed. If the instantaneous Standard Deviation values are equal to or less than the values you've specified, then the measurement can proceed. Once this happens, FieldGenius will start averaging the measurements and will compute and display averaged Standard Deviation values. These averaged Standard Deviation values must then remain equal to or less than the values you've specified for the entire duration of the measurement, for the measurement to be accepted as being within the specified tolerances.

This is your maximum acceptable horizontal standard deviation to be maintained during the point measurement.

StdDev Vertical

This is your maximum acceptable vertical standard deviation to be maintained during the point measurement.

Correction Age

The maximum time (in seconds) since correction data was received.

Point Tolerance

Point Tolerance - Observations

This is the minimum number of observations that the receiver must collect and average in order to compute a solution.

Point Tolerance - Time

This is the minimum time duration that the receiver must collect and average observations in order to compute a solution.

Post Processing Tolerances

These settings apply when using FieldGenius to collect static data for later post processing.

Please note that FieldGenius does not support collecting raw data on all GNSS receivers, please refer to the [Raw Data Logging](#) topic for additional details including a list of receivers which support this function.

Usage

This option determines whether FieldGenius should use Post Process mode to collect static data for later post processing.

Selecting **Always** instructs FieldGenius to automatically switch into Post Process mode to collect static data for all points.

Selecting **Auto Start** instructs FieldGenius to automatically switch into Post Process mode to collect static data for the point currently being measured, if the current solution masks are not met.

Selecting **Manual** allows you to switch into Post Process mode to collect static data for any point as it is being measured, but FieldGenius will not do so automatically.

Time - Less than 5 SVs

This defines the duration of the static collection if the minimum number of satellites being tracked during the static session is 4 satellites. Default = 30 minutes.

If at any time the number of satellites drops below 4 (which is the minimum number of satellites required to post process a 3D solution), the internal clock timing the static session will reset to zero and begin again.

Time - Less than 6 SVs

This defines the duration of the static collection if the minimum number of satellites being tracked during the static session is 5 satellites. Default = 25 minutes.

Time - Less than 7 SVs

This defines the duration of the static collection if the minimum number of satellites being tracked during the static session is 6 satellites. Default = 20 minutes.

Time - Less than 8 SVs

This defines the duration of the static collection if the minimum number of satellites being tracked during the static session is 7 satellites. Default = 15 minutes.

Time - 8 or more SVs

This defines the duration of the static collection if the minimum number of satellites being tracked during the static session is 8 or more satellites. Default = 10 minutes.

GNSS Antenna Height

GNSS Toolbar | Antenna Height

The antenna settings are used to calculate or enter the height of the antenna phase center above the ground. You can enter the true height (if it is known) or enter the measured height and any horizontal or vertical offsets and have FieldGenius calculate the antenna height for you.

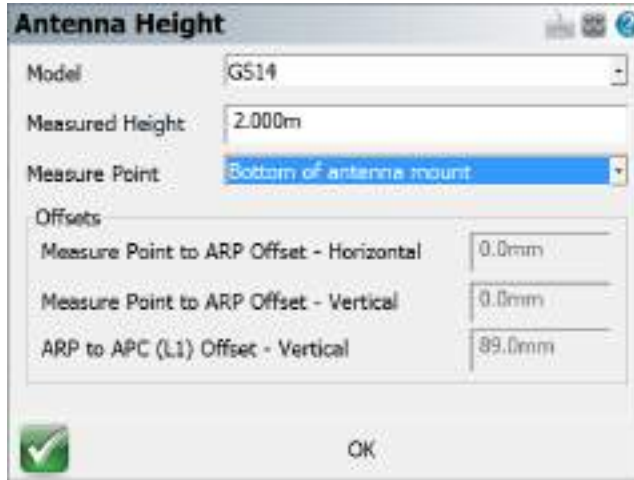

Antenna Height

Model: G514

Measured Height: 2.000m

Measure Point: Bottom of antenna mount

Offsets

Measure Point to ARP Offset - Horizontal	0.0mm
Measure Point to ARP Offset - Vertical	0.0mm
ARP to APC (L1) Offset - Vertical	89.0mm

OK

Depending on the model you've selected, manufacturer specific antenna offsets will be listed. If your specific antenna model is not listed, you can select "User Supplied" and specify appropriate offset measurements. For more detailed information about these offsets, refer to your users guide for your receiver.

The true height is simply computed by the use of Pythagoras' theorem:

$$\text{TrueHeight} = \text{VerticalOffset} + \text{sqrt}((\text{MeasuredHeight})^2 - (\text{HorizontalOffset})^2)$$

You can change the true or measured antenna height at any time, on the [Store Point](#) screen when storing your GNSS shots.

Overview - Reference Receiver

Before you can start your GNSS survey, there are a few things you need to confirm and setup.

Profile and Coordinate System Files

- You will need to determine and select the correct [coordinate system](#) and optional [geoid model](#) to use for your GNSS survey work.
- Create a profile for your reference (base) and rover receivers. Profiles contain receiver settings such as baud rates and tolerance masks that are used by FieldGenius. Refer to the [Reference Configuration](#) and [Rover Configuration](#) topics for more information.

Reference (Base) Connection Procedure

1. Main Menu | Connect | [Instrument Selection](#)
2. Choose **GNSS Reference** as the type of instrument.
3. If you have not already done so, you need to create a profile for your reference receiver. If you have a profile already defined, select it now and then press **Connect**.
4. You will now see the map screen. On the GNSS Toolbar you can review information about receiver, sky plot list, display current position, and review DOP values.
5. Select one of the available methods to set your reference position, described in more detail in the [Reference Position Modes](#) topic. The three different methods are: Known Geodetic Position, Averaged Geodetic Position, or Local Transformation to Point.
6. When you're ready to measure the reference position, press the **Measure** button on the [GNSS Toolbar](#).
7. You will be prompted with an option to store the measured position in the points database.
8. Once the reference position has been set, the [Link Configure](#) dialog will be displayed where you can configure your radio settings to transmit corrections.
9. If setting up your receivers for the first time, press the **Setup** button to set the radio protocol and frequency, etc.
10. Press the **Connect** button to begin broadcasting corrections.
11. This completes the Reference portion of the connection. Disconnect from the Reference receiver and continue to the [Rover Connection](#) steps.

Overview - Rover Receiver

Before you can start your GNSS survey, there are a few things you need to confirm and setup.

Profile and Coordinate System Files

- You will need to determine and select the correct [coordinate system](#) and optional [geoid model](#) to use for your GNSS survey work.
- Create a profile for your reference (base) and rover receivers. Profiles contain receiver settings such as baud rates and tolerance masks that are used by FieldGenius. Refer to the [Reference Configuration](#) and [Rover Configuration](#) topics for more information.

Rover Connection Procedure

1. Main Menu | Connect | [Instrument Selection](#)
2. Choose **GNSS Rover** as the type of instrument.
3. If you have not already done so, you need to create a profile for your rover receiver. If you have a profile already defined, select it now and then press **Connect**.
4. Once connected, the [Link Configure](#) dialog will be displayed where you can configure your correction settings.
5. If setting up your receiver for the first time, additional steps will be required to make the initial connection. Exact steps vary depending on the device type: UHF Radio / GSM / Data Collector Internet.
6. Press the **Connect** button to begin receiving corrections.
7. With a successful connection you will see the map screen. The Measure button might say "**No Link**" to begin with, then switch to "**RTK Float**" and finally to "**RTK Fixed**".
8. To record a position, simply press the **Measure** button on the [GNSS toolbar](#). Refer to the [GNSS Measurement](#) topic for more information.

Electronic Bubble / Tilt Survey

[GNSS Toolbar](#) | [Instrument Settings](#) | [Sensor Configure](#) | [Electronic Bubble](#)

The Electronic Bubble utilizes MEMS sensors in the GNSS receiver to compensate for the antenna pole tilt.

This feature improves the GNSS point collection workflow by:

- Vertical and horizontal distance introduced by the pole tilt will be compensated automatically if desired.
- Eliminate the need to focus on the conventional bubble on the GNSS pole while taking measurements.
- Stop user from saving points if the pole tilt angle is greater than tolerance level.

The Electronic Bubble feature requires calibrations before being used in production works. With a supported GNSS receiver connected, Settings and Calibrations related to the Electronic Bubble can be located in the **Settings** | **Sensor Configure** | **Electronic Bubble** screen.

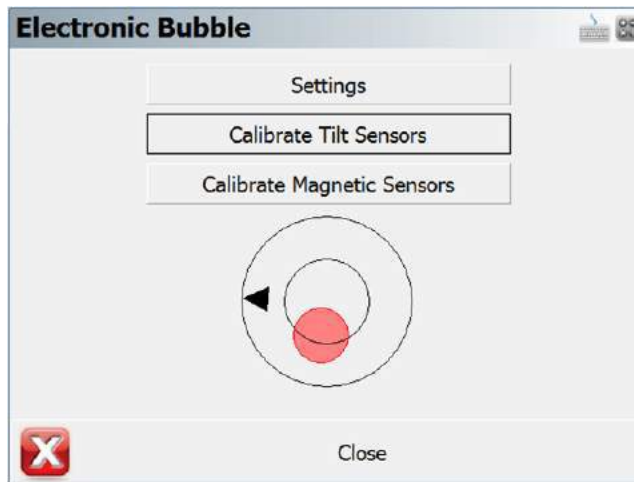

Settings

Electronic Bubble

Toggles Electronic Bubble feature ON/OFF

Tilt Compensated

Toggles tilt compensation ON/OFF

With tilt compensation turned on, tilt distance will be added into the calculation of GNSS measurements.

Tilt Rejection

Toggles tilt rejection ON/OFF

With tilt rejection turned on, user will not be able to store points if the tilt angle exceeds the specified rejection tolerance.

Tilt Rejection (Deg)

Tilt rejection tolerance in degrees. User can only store points if only the tilt angle is below the set limit.

Magnetic Declination

Specify the angle between magnetic north and true north

- *Computed*- Magnetic Declination is computed using International Geomagnetic Reference Field (IGRF-12) model.
- *User* - Enter a desired magnetic declination value.

Calibrate Sensors

Calibrate Tilt Sensors

This procedure calibrates the internal tilt sensor, and stores the zeroed the vertical angle.

1. Click “Calibrate Tilt Sensors” button to enter the procedure.
2. Level the GNSS receiver with a calibrated reference such as a bipod or tripod.
3. Ensure the GNSS receiver is in a stable plumb position.
4. Click “Calibrate” button to finish the tilt sensor calibration.

Note: Control panel on the GNSS receiver must be facing the operator when using the electronic bubble.

Calibrate Magnetic Sensors

This procedure calibrates the internal magnetic sensor.

1. Click “Calibrate Magnetic Sensors” button to enter the procedure.
2. Ensure the GNSS receiver is away from any artificial magnetic sources.
3. Click “Calibrate” button to start the magnetic calibration.
4. **Slowly** rotate the GNSS receiver about its 3 axes to fill up the progress bar.
 - Note that the progress bar will not move unless the instrument is being rotated.

This demonstrate the rotation axes:

- Longitudinal Axis (Roll)
- Lateral Axis (Pitch)
- Vertical Axis (Yaw)

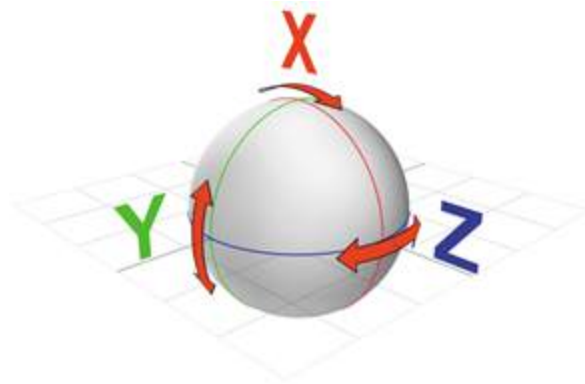

We recommend to perform both calibration procedures on regular basis to ensure the reliability and accuracy of the Electronic Bubble. Magnetic Sensor may require more frequent calibration than tilt sensor depending on your calibration location and distance travelled. Consult with your GNSS receiver manufacture representative for more information regarding calibrate internals.

Settings

Electronic Bubble

After calibration, the electronic bubble can be found in two places.

- Observation toolbar (One of the pages)
- GNSS Measurement screen

The black arrow shows the direction of magnetic north.

The bubble is green if the instrument is plumb, and red if the instrument is tilted beyond certain degree.

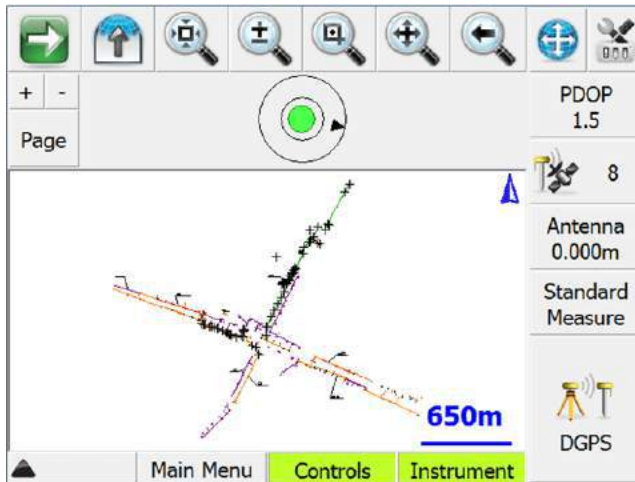

On the GNSS Measurement Screen, if the Tilt Rejection is turned on and current tilt angle exceeds the preset rejection value, the Store Position button will be deactivated and GNSS measurements will not be averaged until the GNSS receiver turns to a plumb and stable position.

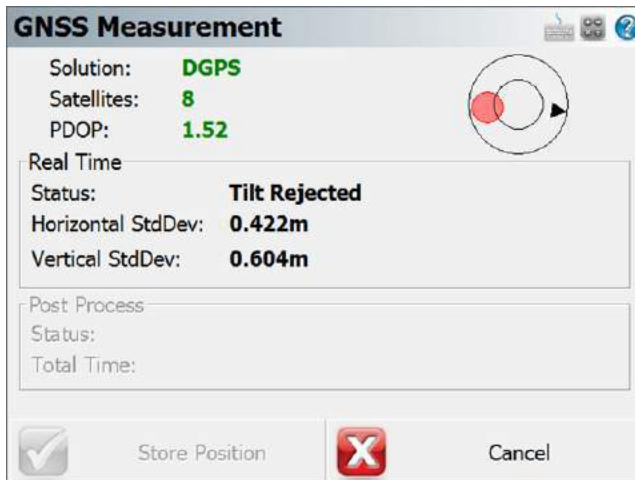

Reference and Rover Common Tools

Correction Link

The Link Configure screen is used to configure the radio or GSM link for transmitting or receiving RTK corrections. The mode will vary depending on your receiver type. The Setup button allows the user to go into further device details including channels and frequencies for radios and GSM modems.

If you need to connect to a NTRIP caster, you can also access that in the setup screen.

Accessing Link Configure

To access this screen you need to first connect to a reference or rover receiver. Once connected you can access this dialog. Please review the [Reference \(Base\) Receiver Overview](#) or the [Rover Receiver Overview](#) topics for more details about work flow.



Device

Device Type

Select the appropriate Correction Link device type, such as GSM Module, UHF Radio Module, Data Collector Internet, or Other Device.

Device Port

Select the appropriate Port when multiple options exist.

Device Setup

When you press the Setup button on the dialog above, the Radio Setup or Modem Setup screen will appear. Choose the radio make and model from the pull-down and set the channel or frequency, the radio will be programmed by FieldGenius to the channel or frequency selected (on some models). If you are using an NTRIP or GPRS server, enter your internet and server credentials here.

Correction Data

Message Type

The message type is used in determining what data streams are sent from the reference station to the rover. They can be RTCM, CMR or a proprietary format.

Base Station ID

Select a specific Base Station ID to restrict message corrections to specific reference stations.

RTCM Transformation

To receive horizontal and vertical coordinate system information from your network, enable RTCM Transformation messages.

GNSS RTCM Transformation

[GNSS Toolbar](#) | [Instrument Settings](#) | [Link Configure](#) | [RTCM Transformation](#)

RTCM Transformation messages can be utilized to provide horizontal and vertical systems from RTK network using RTCM 3.1 or higher correction messages.

At the Link Configure dialog select the option to enable the RTCM Transformation messages.

RTCM Transformation Information

[GNSS Toolbar](#) | [Instrument Settings](#) | [Link Information](#)

Information Table:

The information table displays the mountpoint name, current status of the incoming corrections, and coordinate systems information received from the NTRIP Caster.

NTRIP casters typically do not send out RTCM transformation messages at the same frequency as RTK correction messages. A 90 seconds waiting time is reserved to receive the messages.

Please ensure the Target System field is what you would expect at current location.

If no the transformation messages are not received after 90s, the **Options** screen will automatically show up, which allows you to select a valid predefined coordinate system or choose a different mount point.

OK:

The OK button will only become active if valid transformation messages are received.

Options:

- **Coordinate System** - Predefined coordinate systems can be used if you no longer wish to use RTCM transformation. Horizontal and Vertical system can be selected separately.
- **Mount Points** - A different mount points can be selected if the current mount point do not support RTCM messages.
- **Go Back** - Allows you go back to the previous screen and continue waiting for incoming messages
- **Cancel** - This button will exit the link configuration work flow and bring out the map view. You will need to select a valid coordinate system before taking measurement if the RTCM transformation messages are not received.

Correction Information

GNSS Toolbar | Instrument Settings | Link Information

The Correction Information screen is accessed from the [GNSS Settings](#) screen. It displays information about the correction message being received by your receiver via a radio link from a base receiver, or via a cellular modem link from an NTRIP or GPRS server.

Link Information	
Information	
Data Age	1.0 sec
Data Quality	100%
Status	RTK corrections being received
RTCM Transformation	Not Applicable.
Reference	
Identification	1
Latitude	N49°50'16.93114"
Longitude	W119°36'36.29246"
Ellipsoid Height	400.017...
 OK	

For information on configuring your correction link please see the [Correction Link](#) topic.

GNSS Satellite Plot



To access this screen, press the Satellite button on the GNSS Toolbar.

The Satellite Plot screen is a graphical representation of the current GNSS satellite constellation. It shows all visible satellites including both GPS and GLONASS. Those satellites being used in the current solution are indicated with a black dot, and those being ignored are indicated with a white dot.

Each satellite is displayed with its PRN (identification) number, and the Elevation Mask specified in your current [Tolerance Mode](#) is indicated by a red dashed line.

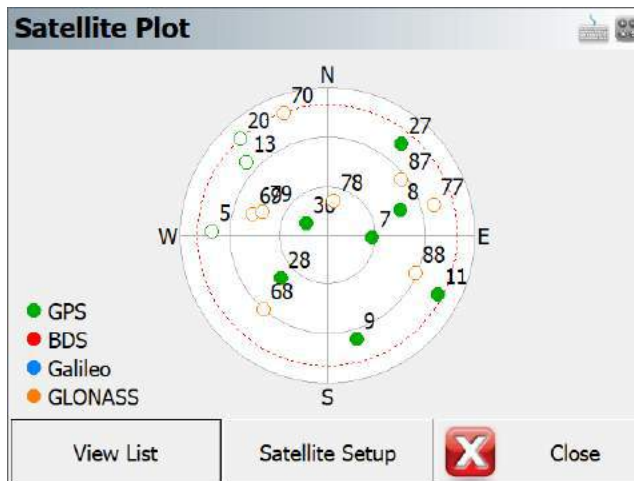

Press the **View List** button to open the [Satellite List](#) screen.

Press the **Satellite Setup** button to enable/disable constellations.

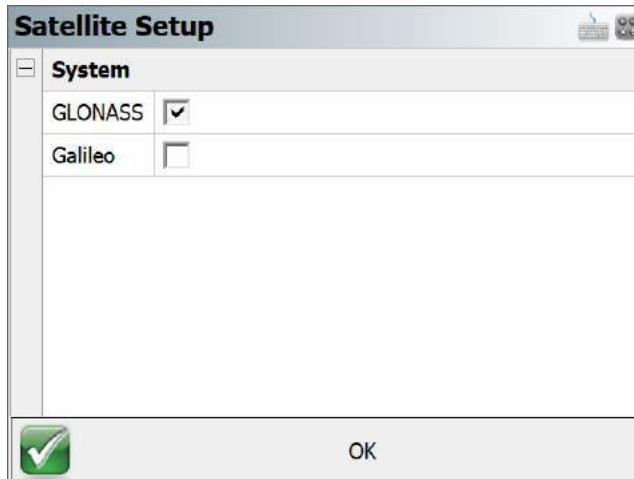

Press the **Close** button to return to the map screen.

GNSS Satellite List



To access this screen, press the Satellite button on the GNSS Toolbar, then press the **View List** button on the [Satellite Plot](#) screen.

The Satellite List screen displays information on the current GNSS satellite constellation. It shows all visible satellites including both GPS and GLONASS. Those satellites being used in the current solution are indicated with a checkmark, and those being ignored are indicated with an X.

Each satellite is displayed with its PRN (identification) number, Azimuth and Elevation, and Signal-to-Noise Ratio.

Satellite List			
PRN	System	Azimuth	Elevation
<input type="checkbox"/> 5	GPS	272°	19°
<input checked="" type="checkbox"/> 7	GPS	93°	62°
<input checked="" type="checkbox"/> 8	GPS	72°	42°
<input checked="" type="checkbox"/> 9	GPS	164°	24°
<input type="checkbox"/> 11	GPS	118°	12°
<input type="checkbox"/> 13	GPS	312°	23°
<input type="checkbox"/> 20	GPS	319°	10°
<input checked="" type="checkbox"/> 27	GPS	20°	18°

View Plot Satellite Setup Close

Press the **View Plot** button to open the [Satellite Plot](#) screen.

Press the **Close** button to return to the map screen.

GNSS Settings



The GNSS Settings screen is accessed from the [GNSS Toolbar](#).

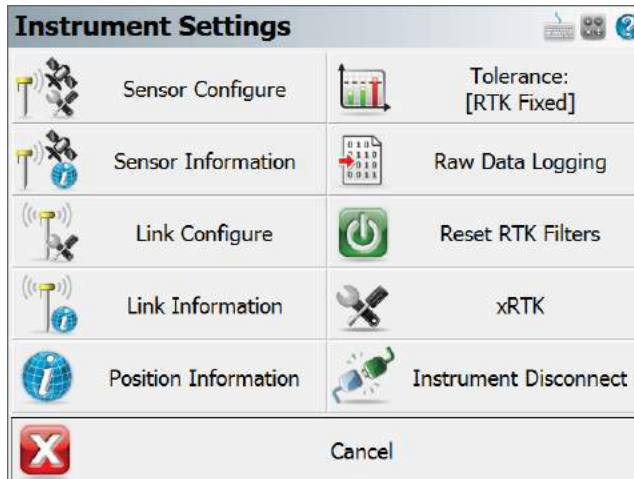

Sensor Configure

This will allow you to make changes to most of the settings in your [reference](#) or [rover profile](#), including configuring the three tolerance modes, selecting the active tolerance mode, configuring the antenna height, configuring the auto-recording options and depending on the GNSS Sensor connected, the Electronic Bubble settings will be shown here as well. (The Model and Communication options cannot be configured while you are connected to your GNSS receiver.)

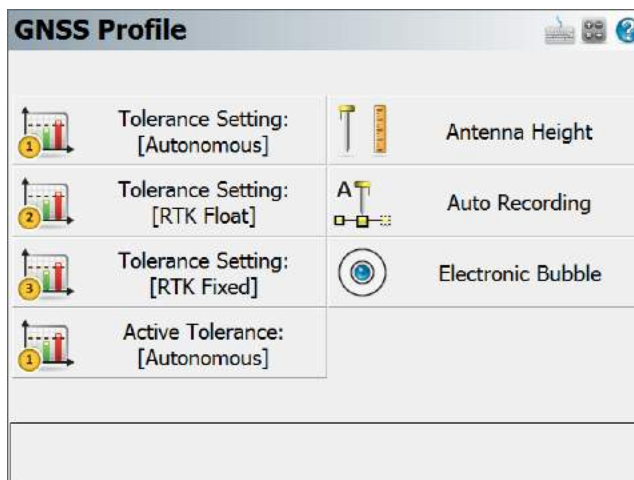

Sensor Information

The [Sensor Information](#) screen displays detailed information about the hardware you are connected to.



Sensor Information	
GNSS Driver	GS14
Hardware	GS14
Serial Number	2810059
System Version	6.13
Measure Version	6.515
Boot Version	6.06
Battery	100%
Battery Ext	None

<  OK

Link Configure

This turns on your GNSS Receiver's [radio or modem](#) to begin receiving RTK corrections, from either a base receiver or an NTRIP or GPRS server.

Link Configure	
Device	
Device Type	GSM Module
Device Port	Internal
Device Setup	Press to Setup
Correction Data	
Message Type	RTCM 3
Base Station ID	Any
RTCM Transformation	
Enable	<input type="checkbox"/>

 Connect  Close

Link Information

The [Link Information](#) screen displays detailed real-time information about the correction message being received by your receiver via a radio link from a base receiver, or via a cellular modem link from an NTRIP or GPRS server.

Link Information	
Information	
Data Age	1.0 sec
Data Quality	100%
Status	RTK corrections being received
RTCM Transformation	Not Applicable.
Reference	
Identification	1
Latitude	N49°50'16.93114"
Longitude	W119°36'36.29246"
Ellipsoidal Height	400.017m

OK

Position Information

The [Position Information](#) screen displays detailed real-time information about your current position.

Position Information	
Latitude	N49°50'16.74805"
Longitude	W119°36'35.51927"
Ellipsoidal Height	387.265m
Antenna Hgt (Meas)	2.000m
Distance to Reference	Not Available
Northing	5523884.777m
Easting	312341.551m
Elevation	387.265m
Horz System	UTM83-11
Vert System	Ellipsoidal (WGS84)

OK

Antenna Height

The [Antenna Height](#) screen allows you to configure the antenna height of your GNSS receiver.

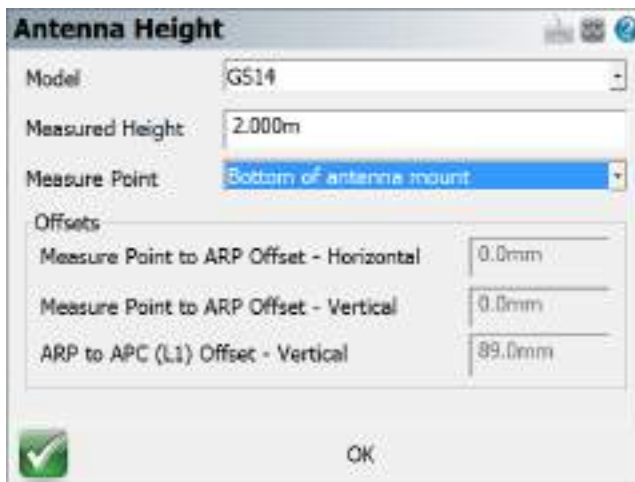

Active Tolerance Mode

This button indicates which of the three [tolerance modes](#) setup in your Rover Profile is currently being used. Press this button to select the active tolerance mode. To configure the three tolerance modes, see the "Sensor Configure" button described above.

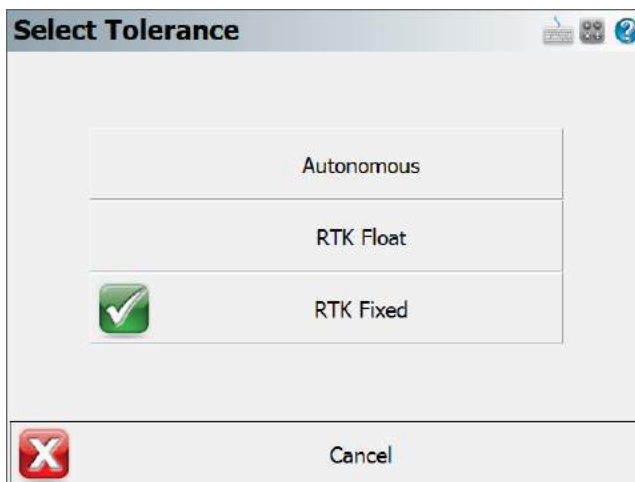

Raw Data Logging

The [Raw Data Logging](#) screen is used to start and stop raw data logging on your GNSS reference or rover receiver, for later post-processing.

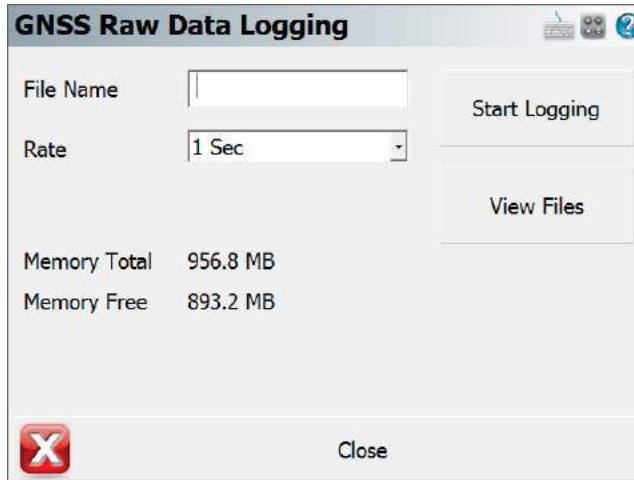

Reset RTK Filters

Use this to reset the RTK solution in your receiver, to force it to recalculate a new solution and resolve any ambiguities again from scratch. This has the same effect as inverting your receiver to reset the solution.

Select Mount Point

Use this to select a different mount point from the NTRIP caster you are currently connected to.

Instrument Disconnect

Use this to disconnect from your receiver. If you are connected to a reference receiver, corrections will continue to be transmitted after you disconnect.

Sensor Information

[GNSS Toolbar](#) | [Instrument Settings](#) | [Sensor Information](#)

The Sensor Information screen is accessed from the [GNSS Settings](#) screen. It displays information about the hardware you are connected to. The specific information available will vary by model, but typically you will see the make and model of your receiver, its serial number, battery status, firmware information, and more.

Sensor Information	
GNSS Driver	GS14
Hardware	GS14
Serial Number	2810059
System Version	6.13
Measure Version	6.515
Boot Version	6.06
Battery	100%
Battery Ext	None

<  OK >

Position Information

[GNSS Toolbar](#) | [Instrument Settings](#) | [Position Information](#)

The Position Information screen is accessed from the [GNSS Settings](#) screen. It displays detailed information about your current position.

Position Information	
Latitude	N49°50'16.74805"
Longitude	W119°36'35.51927"
Ellipsoidal Height	387.265m
Antenna Hgt (Meas)	2.000m
Distance to Reference	Not Available
Northing	5523884.777m
Easting	312341.551m
Elevation	387.265m
Horz System	UTM83-11
Vert System	Ellipsoidal (WGS84)

OK

The following information is displayed and updates in real-time:

- Geodetic Position (Latitude, Longitude, Ellipsoid Height)
- Measured Antenna Height
- Baseline Length
- Cartesian Position (Northing, Easting, Elevation)
- Coordinate Systems (Horizontal and Vertical)
- Solution Type
- Standard Deviation
- PDOP
- Number of Satellites
- UTC Date and Time

Raw Data Logging

[GNSS Toolbar](#) | [Instrument Settings](#) | [Raw Data Logging](#)

Use this to start and stop raw data logging on your GNSS reference or rover receiver, for later post-processing of your point data. You can log raw data on the receiver while you carry on with your survey in FieldGenius.

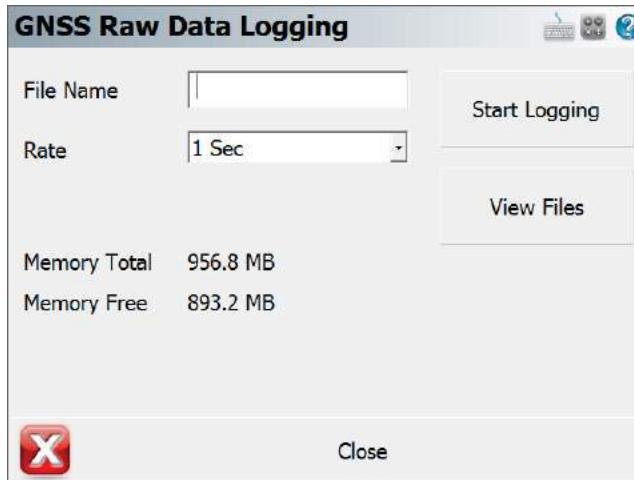

Note: FieldGenius cannot control the data logging on all models of GNSS receivers. Currently, we support data logging on the:

- | | | |
|------------------------------|-------------------|-------------------------|
| Acnovo GX9 | GINTEC G9 | Pentax SMT888-3G Rev 2 |
| Acnovo GX10 | GINTEC G10 | Prexiso G4/G5 |
| Altus APS-3 | Hemisphere S320 | Septentrio Altus APS3G |
| Altus APS-3G | Hemisphere S321 | Septentrio Altus NR2 |
| Altus APS-NR2 | Horizon Kronos C3 | Sokkia GRX1 |
| Ashtech / Thales ProMark 500 | Javad Triumph-1 | Sokkia GSR2600 |
| Ashtech / Thales ProMark 800 | KOLIDA K5 Plus | SOUTH GALAXY G1/G1 Plus |
| Champion AllStar | LINERTEC LGN-200S | SOUTH GALAXY G6 |
| Champion Pro | Leica 1200 | SOUTH S82/S82-V |
| CHC i80 | Leica GS15 | SOUTH S86 |
| CHC X900+ | Leica GS10 | Spectra Precision SP80 |
| CHC X91+ | Leica SmartRover | STONEX S8 Plus |
| ComNav T300 | Leica GPS900 | STONEX S9i |
| geo-FENNEL FGS 1 | NavCom SF-3040 | STONEX S9III Plus |
| GeoMax Zenith10 | NavCom SF-3050 | STONEX S10 |
| GeoMax Zenith15 | NovAtel DL4 | Topcon GR-3 |
| GeoMax Zenith20 | Pentax G3100-R1 | Topcon HiPer |
| GeoMax Zenith25/25Pro | Pentax G3100-R2 | Z-SURVEY Z6 |
| GeoMax Zenith35/35Pro | Pentax SMT888-3G | |

Command Console

[GNSS Toolbar](#) | [Instrument Settings](#) | [Command Console](#)

The Command Console screen is accessed from the [GNSS Settings](#) screen. It allows you to send commands to your receiver to configure settings, or other related tasks.

You must determine the exact syntax to enter in the console and you can usually gather this information from your GNSS manufacturer.

Send

This will send the parameters that you've entered to your receiver.

Run Script

This allows you to import and read a text file that has a sequence of commands that you would like to upload to your receiver.

Clear Console

This will clear console of all parameters sent and received from your receiver.



DISTO/LASER REFERENCE

[Main Menu](#) | [Connect](#) | [Disto/Laser](#)

3D Disto

To use a 3D Disto:

- Having a serial number starting with **175** or **177** requires the 3D Disto Software for Windows installed on your computer to make the initial USB or WiFi connection. These devices also are recommended to be used with a USB WiFi stick for WiFi connectivity.
- Having a serial number starting with **176** will connect automatically without the 3D Disto Software for Windows, and does not require a USB WiFi stick.

FieldGenius supports live video streaming from the 3D Disto camera into the MapView area. Use the controls at the edges of the video image to turn the 3D Disto, or tap on the image to turn to the point.

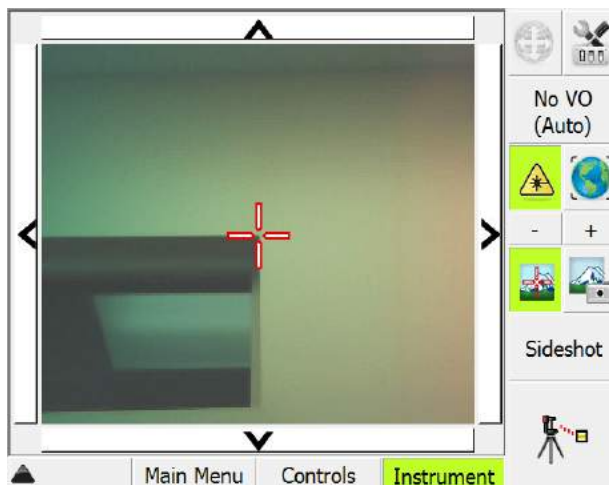

To measure a location simply press the measure button in FieldGenius.

Staking

To stakeout a location simply start any of the Staking routines. The 3D Disto will automatically turn to the point you are trying to locate. Press the measure button to calculate a position.

Additional Information

The following topics make use of the 3D Disto

- [Pipe Through Wall](#)
- [Point on Floor and Ceiling](#)
- [Point On Wall](#)

3D Disto Connection Guide

The general connection procedure for Leica 3D Disto:

1. Only required for devices having serial numbers starting with **175** or **177**:
 - Download the latest 3D Disto software for Windows from [Leica myWorld](#).
 - Install the 3D Disto software and run it.
 - In the 3D Disto software, select the **Connect USB** or **Connect WiFi** button to connect:



- Once connected, the main screen of the 3D Disto software will be displayed. The communication ports are now configured on the PC/Tablet.
 - Close the 3D Disto software.
2. Launch FieldGenius and open a Project.
 3. At the Instrument Selection screen, pick the **Disto/Laser** type and choose the pre-configured **3D Disto** profile, then pick **Edit**:



4. Choose Model and Communication.

5. Pick the Connection Type:

- If choosing **USB** you are ready to Connect, pick **Connect**
- If choosing **WiFi** you will need to perform a WiFi search first, pick **Search** to search for 3D Disto devices. If successfully found, pick **Connect**

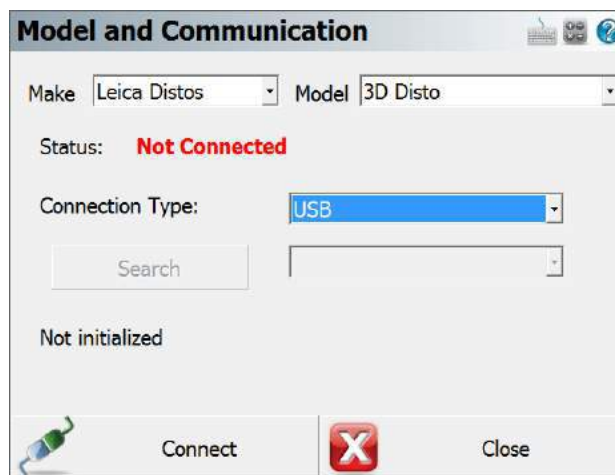

6. Complete, see the [Measure Modes \(Disto/Laser\)](#) topic for supported functionality.

S910 Disto

The Leica S910 Disto is fully supported using a WiFi connection. It can be operated using workflows very similar to a Total Station when combined with a tripod or stand. Without a tripod or stand, the S910 can be used to capture distances for various applications, including:

- The [Drawing Tool](#)
- [Traverse / Intersection](#) calculations
- [Trilateration](#) calculations

Disto S910 Connection Guide

The general connection procedure for Leica Disto S910:

1. Launch FieldGenius and open a Project.
2. At the Instrument Selection screen, pick the **Disto/Laser** type and choose the pre-configured **Disto S910** profile, then pick **Edit**:

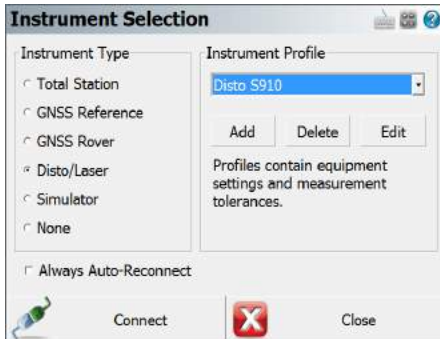

3. Choose Model and Communication.
4. **WiFi** is the only supported Connection Type, pick **Search** to search for Disto S910 devices. If successfully found, pick **Connect**.

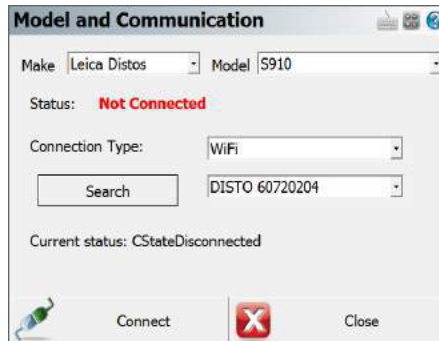

5. Complete, see the [Measure Modes \(Disto/Laser\)](#) topic for supported functionality.

Bluetooth Disto

FieldGenius supports handheld Leica Distos with Bluetooth connectivity. Supported models include Disto A6 and D330i. Bluetooth LE is not currently supported (E7100i, E7500i, etc.). Supported models are able to capture distances for various applications, including:

- The [Drawing Tool](#)
- [Traverse / Intersection](#) calculations
- [Trilateration](#) calculations

CONNECTING TO COMPUTER

Microsoft ActiveSync / Windows Mobile Device Center

Microsoft ActiveSync and Microsoft Windows Mobile Device Center facilitate communication between your PC and your handheld device.

If you are using Windows XP or earlier, **Microsoft ActiveSync** has to be installed on your computer so you can download data between your hand held and desktop computers. The current version (at time of printing) is ActiveSync 4.5. You may have to use an earlier version if you are running Windows 95 or 98. Check the web page noted below for more information.

If you are using Windows Vista, **Microsoft Windows Mobile Device Center** has to be installed on your computer, rather than Microsoft ActiveSync. The current version (at time of printing) is Windows Mobile Device Center 6.1.

Installing ActiveSync / Windows Mobile Device Center

Installing From Web

Microsoft ActiveSync or Microsoft Windows Mobile Device Center might already be installed on your computer; you can confirm this by looking for it in your Windows Start Menu.

If you do not have Microsoft ActiveSync or the Windows Mobile Device Center installed, you can download and install the latest version from Microsoft's website at this address:

<http://www.microsoft.com/windowsmobile/activesync/default.mspx>

Note: You may be asked to reboot your system once the installation is complete.

Installing From CD

Microsoft ActiveSync or Microsoft Windows Mobile Device Center might be already be installed on your computer, you can confirm this by looking for it in your Windows Start Menu.

If you do not have Microsoft ActiveSync or the Windows Mobile Device Center installed, and you don't have access to the internet, it can be installed from your FieldGenius CD. You can browse into the FieldGenius folder on your CD and run one of the following files:

MSASYNC.EXE (for Windows XP or earlier)

MSWMDC32.EXE (for Windows Vista 32-bit)

MSWMDC64.EXE(for Windows Vista 64-bit)

Note: You may be asked to reboot your system once the installation is complete.

Connecting ActiveSync / Windows Mobile Device Center

Get Connected

We now need to establish a connection between your data collector and desktop computer as prompted by the ActiveSync or Windows Mobile Device Center Connection Wizard. The following screenshots are specific to ActiveSync, but the Mobile Device Center is almost identical.

After the install is complete, ActiveSync will display a Get Connected screen.

If ActiveSync was already installed, you can start it by going to your Start menu | All Programs | Microsoft ActiveSync. The Get Connected Wizard should appear. If it does not, go to the ActiveSync **File** menu and select **Get Connected**.

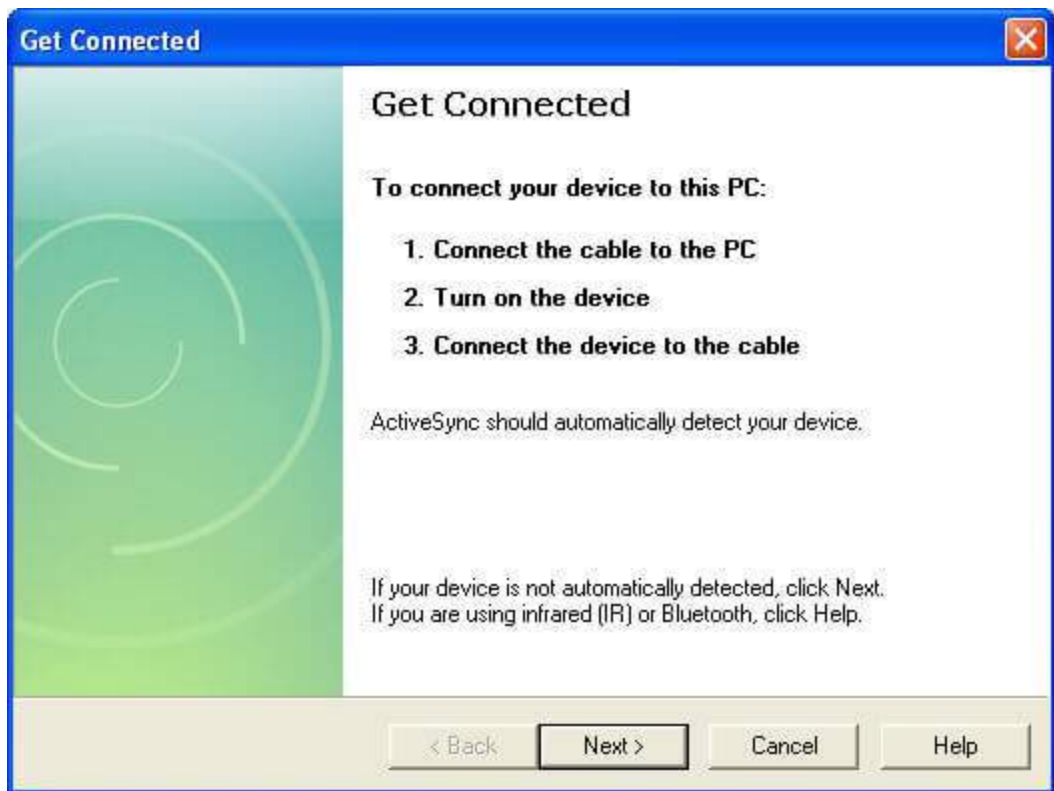

Connect your handheld data collector to your desktop or laptop computer using the supplied cradle and/or cables.

Power ON the data collector and click **Next** on the Get Connected Wizard. Some devices require you to tap a **PC Link** icon on the device while the Get Connected function is in operation.

When communication is established, you will be prompted to set up a partnership between your data collector and the desktop computer.

Note: If your device does not connect as shown, turn the device off, and then back on again to retry

Establish a Guest Connection

After you successfully connect to your computer, you will be asked to setup a partnership. Choose **Guest Partnership** then click **Next** to continue.

Note:

You can setup a Standard Partnership if desired, but this is not necessary and adds complexity. We recommend using a Guest Partnership.



Or if you are using a handheld device running Windows Mobile 5.0 or newer, you may instead see the Synchronization Setup Wizard, simply press **Cancel** to use a guest connection.

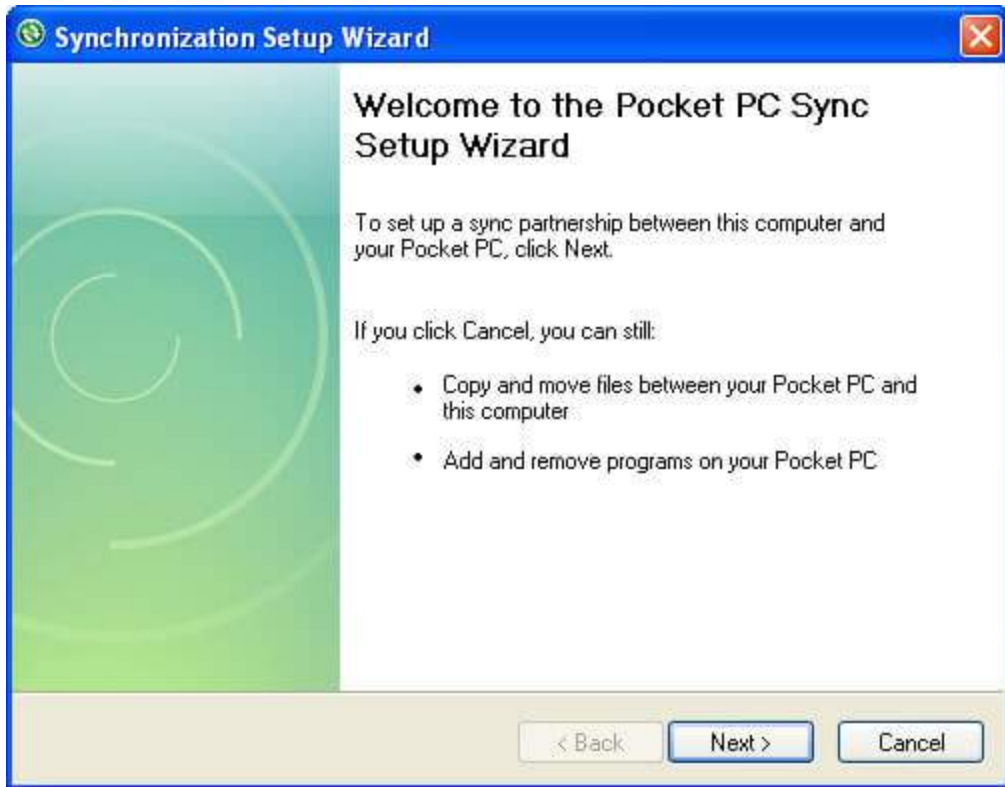

ActiveSync should now display as shown below:

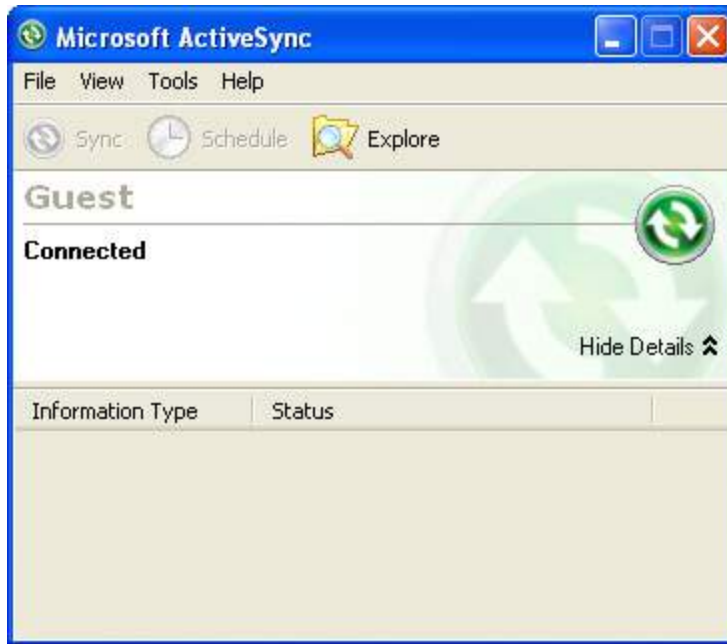

You are now ready to move on to the next step - [MicroSurvey Transfer Program](#)

Note:

A small circular ActiveSync icon will appear in the lower right corner of your desktop (like the one at right in the above image). This will display in gray when ActiveSync is inactive but will change to green when your device is connected.

MicroSurvey Transfer

We provide a free transfer tool with FieldGenius to help you copy Projects to and from your data collector. The program is called MicroSurvey Transfer and it can be download from our website or installed directly off of the CD provided with FieldGenius.

Once installed all you need is to connect your handheld computer to your desktop computer via an [ActiveSync or Windows Mobile Device Center](#) connection. ActiveSync is a Microsoft Windows product which establishes a serial or USB connection between your data collector and your computer.

Once connected, you can start the MicroSurvey Transfer program.



The program has been designed to streamline the transfer of Projects and files back and forth between you data collector and computer.

For more details, please refer to the Help file included with the MicroSurvey Transfer program.

Synchronize

To import your Projects into your MicroSurvey CAD or inCAD desktop product, please refer to the **FieldGenius SyncWizard** topic in the MicroSurvey CAD or inCAD help file.



FieldGenius 2004/2005 Projects can only be imported directly into MicroSurvey CAD 2004 or later, or inCAD 2004 or later.

FieldGenius 2006 (and newer) Projects with an unencrypted raw file (*.raw) can only be imported into MicroSurvey CAD 2005 SP1.2 or later, or inCAD 2006 or later.

FieldGenius 2007 (and newer) Projects with an encrypted raw file (*.rae) can only be imported into MicroSurvey CAD 2008 or newer.

RAW FILE REFERENCE

Raw File Record Types

To increase our compatibility with other data collectors and desktop systems, FieldGenius uses the TDS RW5 raw file format. The raw file contains virtually all the measurements made in the field and is a complete history of what was recorded.

For more information on the raw data record format, or for additional record types, please review the Raw Data Record Specification document from Tripod Data Systems, Inc. It is available for download at www.tdsway.com

Conventional Raw Data Records

-- - Note or Comment Records

A comment in the raw file will be depicted with a record type of two dashes. Text found after the dash is the comment.

Comments are ignored during processing of the raw file and are used only for information purposes only. You can add a comment to the raw file by using the Add Comment button in the [Survey Tools](#) Menu.

```
| -- This is a comment |
```

BK - Backsight Record

A backsight record is written to the raw file when you complete an occupy point command. Please review the [Setup Occupy Point](#) topic for more information.

Field headers:

OP: Occupy point

BP: Back point

BS: Backsight

BC: Back circle

```
| BK,OP101,BP100,BS0.00000,BC0.00000 |
```

CF - Cut Sheet

When you stake out a point, a CF record will be recorded in the raw file.

ST: Station

OD: Offset direction (ENUM)

OL: Offset length

EL: Elevation

GD: Grade (design)

DE - Design Point / Location

During a stakeout the point you're staking will be recorded in the raw file with as DE record.

PN: Point name (*design point, may be blank*)

N : Northing

E : Easting

EL: Elevation

--: Description (*design point description, may be blank*)

JB - Job Record

Every time a raw file is created or opened a JB record will be written to the file.

Field headers:

NM: Job name

DT: Date

TM: Time

```
{ JB,NMTraverse1,DT03-05-2004,TM14:07:52 }
```

LS - Line of Sight (Instrument and Target Height)

HI: Height of instrument

HR: Height of rod

```
{ LS,HI1.500,HR1.500 }
```

MO - Mode Setup Record

Every time a raw file is created or opened a MO record will be written to the file.

Field headers:

AD: Azimuth direction - (0 = North) (1 = South)

UN: Distance unit - (0 = Feet) (1=Meter) (2=US Survey Feet)

SF: Scale factor

EC: Earth curvature - (0 = off) (1=On)

EO: EDM offset (inch) (Default string "0.0") **Not used by FieldGenius

AU: Angle unit - (0=Degree) (1=Grads)

```
|MO,AD0,UN1,SF1.000000,EC0,EO0.0,AU0|
```

OC - Occupy Point Record

When you complete the occupy point command an OC record will be written to the raw file. Please review the [Setup Occupy Point](#) topic for more information.

Field headers:

OP: Point number

N : Northing (the header is N space)

E : Easting (the header is E space)

EL: Elevation

--: Description

```
|OC,OP101,N 1000.0000,E 1000.0000,EL10.0000,--|
```

OF - Off Center Shot Record

When you use any of the offset shot commands an OF record will be written to the raw file. Two types of measurements will create offset records and they are the Angle Offset and Distance Offset mMeasure Modes. Please see the Measure Modes topic for more information.

Field headers:

AR: Angle right

ZE: Zenith

SD: Slope distance

OL: Offset length

HD: Horizontal distance

VD: Vertical distance

LR: Left/Right Offset

```
| OF,AR90.00000,ZE90.00000,SD50.0000  
| OF,ZE60.00000,--Vert Angle Offset  
| OF,OL45.00000,--Right Angle Offset  
| OF,HD-10.0000,--Horizontal Distance Offset  
| OF,LR0.0000,--Left / Right Offset  
| OF,VD0.0000,--Elevation Offset
```

Offset shots will always contain the original measurement plus the offset information. You will also see a SS record accompany the OF records and it will contain the reduced measurement. Following is an example of a distance offset where an offset of -10 was entered:

```
| OF,AR180.00000,ZE90.00000,SD50.0000  
| OF,HD-10.0000,--Horizontal Distance Offset  
| OF,LR0.0000,--Left / Right Offset  
| OF,VD0.0000,--Elevation Offset  
| LS,HI1.500,HR1.500  
| SS,OP1,FP5,AR180.00000,ZE90.00000,SD40.0000,--<No Desc>
```

RB – Repeat Backsight

When using the multiset function, a RB record will be recorded to the raw file for each backsight shot you measure. Please refer to the [Muti-Set](#) topic for more information.

Field headers:

OP: Occupied point

BP: Backsight point

AR: Angle right

ZE: Zenith angle

SD: Slope distance

HR: Height of rod

```
| RB,OP333,BP100,AR79.48560,ZE93.42500,SD1.9700,HR1.500,--
```

RF - Repeat Foresight

When you use the multiset function, a RF record will be recorded to the raw file for each foresight shot you measure. Please refer to the [Muti-Set](#) topic for more information.

OP: Occupied point

FP: Foresight point

AR: Angle right

ZE: Zenith angle

SD: Slope distance

HR: Height of rod at the foresight

--: Description

```
| RE, OP333, FP888, AR20.45530, ZE89.56080, SD1.9800, HR1.500, --<No Desc> |
```

RE - Remote Elevation

When you use the Benchmark Shot function a RE record will be recorded in the raw file. RE records will be accompanied by a SP record.

The FE value will be defined by the Benchmark Method selected by the user as being either an existing point or a user entered value. Please refer to the [Measure Benchmark](#) topic for more information.

OP: Occupied point

FE: Foresight elevation

ZE: Zenith angle

SD: Slope distance

--: (always "Remote elev")

```
| RE, OP1, FE10.000, ZE90.00000, SD50.0000, --Remote elev |
```

RS - Resection

When you use the resection function a RS record will be recorded for each observation made to your control points. Please refer to the Resection topic for more information.

PN: Point number

CR: Circular reading

ZE: Zenith (or VA, CE)

SD: Slope distance (or HD)

```
| RS, PN103, CR2.42220, ZE90.00000, SD25.0980 |
```

When you complete a resection the control points you used will be written as SP records and after the RS records you will see one final SP for the computed resection point. An example of a resection is shown below:

```
| --Resection  
| SP, PN103, N 3135.070, E 1511.185, EL399.795, --:  
| SP, PN100, N 3097.874, E 1564.984, EL399.387, --:  
| LS, HI1.300, HR0.000  
| RS, PN103, CR2.42220, ZE90.00000, SD25.0980 |
```

```
| RS,PN100,CR102.26120,ZE90.00000,SD56.3050  
| SP,PN999,N 3110.000,E 1510.000,EL398.291,--
```

SD - Stakeout Deltas

When you complete a stakeout by pressing the store point command a SD record will be written to the raw file. It is the difference between the design location (DE record) and the actual point staked (SP record).

ND: Delta northing

ED: Delta easting

LD: Delta elevation

SK - Stake Out Record

When you stake out a point and use the Store Point command a SK record will be written to the raw file. This is the raw observation that was recorded when you stored you stake point.

OP: Occupy point

FP: Foresight point

AR: Angle right

ZE: Zenith

SD: Slope distance

```
| SK,OP251,FP10000,AR175.00000,ZE90.00000,SD6.0000,--Design Point: 342
```

SL - Slope Staking Record

ST: Station

OD: Offset direction (ENUM)

EL: Actual catch point elevation

GD: Grade (design elevation of the catch point based on the slope line)

AS: Ahead on station (positive when rod is beyond design station, negative when before station)

HH: Horizontal distance to hinge point (always positive)

VH: Vertical distance to hinge point (positive when rod is above hinge)

HC: Horizontal distance to center line (always positive)

VC: Vertical distance to center point (positive when rod is above center point)

CF: Slope sed (ENUM)

DS: Design slope

OB: Observed slope

SP - Store Point

Many routines in FieldGenius will write a SP record to the raw file. SP records contain coordinate information that can be used for setups, resections, etc...

PN: Point number

N: Northing

E: Easting

EL: Elevation

--: Description

```
| SP,PN103,N 3135.070,E 1511.185,EL399.795,--: |
```

SS - Sideshot

When you record a shot a SS record will be recorded in the raw file. Many other functions also create a SS record such as when offset and multi set shots are reduced.

OP: Occupy point

FP: Foresight point

AR: Angle right

ZE: Zenith

SD: Slope distance

--: Description

```
| SS,OP1,FP7,AR176.11093,ZE90.00000,SD60.1332,--<No Desc> |
```

TR - Traverse Shot

When you record your shot as a Traverse shot, a TR record will be recorded to the raw file. Please refer to the Measurement Info and [Traverse Report](#) topics for more information.

OP: Occupy point

FP: Foresight point

AR: Angle right

ZE: Zenith

SD: Slope distance

--: Description

| TR,OP1,FP7,AR176.11093,ZE90.00000,SD60.1332,--<No Desc> |

GPS Raw Data Records

AH - GPS Antenna Height

DC: Derivation Code (ENUM)

MA: Measured antenna height

ME: Measure Method (ENUM)

RA: Reduced antenna height (to phase center)

BL - GPS Base Line

DC: Derivation

PN: Point Name

DX: Base line Delta X

DY: Base line Delta Y

DZ: Base line Delta Z

-- : Description (Feature Code)

GM: GPS Measure Method (ENUM)

CL: Classification

HP: Horizontal Precision

VP: Vertical Precision

BP - Set Base Receiver Position

PN: Point Name

LA: Latitude

LN: Longitude

HT: Ellipsoid Height

SG: Setup Group (default = 0)

CS - Coordinate System Identity

CO: Coordinate system option (ENUM)

ZG: Zone group (system) name

ZN: Zone name

DN: Datum name

CT - Calibration Point

PN: Point Name

DM: Dimensions used (ENUM)

RH: Horizontal residual

RV: Vertical residual

CV - RMS Covariance of GPR Position

DC: Derivation (ENUM)

SV: Minimum number of SV during observation

SC: Error Scale

XX: Variance X

XY: Covariance X,Y

XZ: Covariance X,Z

YY: Variance Y

YZ: Covariance Y,Z

ZZ: Variance Z

EP - Geodetic Position

When you save the location of a point, its geodetic position is also recorded.

TM: Time

LA: Latitude

LN: Longitude

HT: Ellipsoid Height

RH: Horizontal RMS returned from receiver

RV: Vertical RMS returned from receiver

DH: HDOP if receiver returns this info

DV: VDOP if receiver returns this info

GM: GPS Method (ENUM)

CL: Classification (ENUM)

HA - Horizontal Calibration (Adjust)

N : Origin north

E : Origin east

TH: Translation north

TE: Translation east

RT: Rotation about origin

SF: Scale factor at origin

GS - GPS Store Point

This is similar to a regular SP (store point) record but the GS indicates that it is create by GPS.

PN: Point Name

N : Local Northing

E : Local Easting

EL: Local Elevation

-- : Description

RP - Local coordinates of calibration point

N : Northing

E : Easting

EL: Elevation

-- : Description

VA - Vertical Calibration (Adjust)

PV: Type of vertical adjustment (ENUM)

N : Origin north (*may be blank*)

E : Origin east (*may be blank*)

LZ: Constant adjustment – translation Z (*may be blank*)

SO: Slope north (*may be blank*)

SA: Slope east (*may be blank*)

GN: Geoid Model Name

INDEX

2

2D Disto 571

3

3-Point Arcs 104

3D Disto 383, 388, 571

3D View Toolbar 59

A

About Menu 162

Absolute Constant 532, 534

Acres 334

Activation 24

Active Figure 97, 102

Active Linework 89

Active Tolerance Mode 564

ActiveSync 577

Add Invert 209, 258

Adjust Traverse 289

Advanced Template Editing 466

Alignment DTM Surface 473

Alignment Slope Staking 488

Alignment Staking 474, 483

Alignments 407, 443

Angle Balance 289

Angle Offset 201, 204

Angle Unit 142

Antenna Height 547, 564

Arc Mode 115, 277

Arcs 104

Area Calculator 334

Area Volume 434

ASCII Coordinate File 392, 395

ATR 510

Attributes 84

Audio Notes 87

Auto-Center 61, 66, 510

Auto-Locate 380, 383, 387

Auto Recording 248

Auto Store 189

AutoMap Library 80, 111, 154

Automatic Save 42

Autonomous 237

Averaged 306

Averaged Geodetic Position 236

B

Backsight 167, 184, 516, 526

Backsight Baseline 265

Backsight Measure Mode 170

Backsight Summary 171, 174

Backup Coordinate System 416

Balance Traverse 289

Base Receiver 236, 548

Base Receiver Setup 235

Base Setup 548

Base Tolerances 543

Basic Measure 515

Benchmark 182

Bluetooth 497, 542

Breaklines 436

Buttons 40
By Distance 80

C

Calculations 307
Calculator 42, 332, 334, 344, 346, 348
Cartesian Coordinate 346
Caster 565
Centerline Alignment 446
CgPoints 406
Chains 408
Check Backsight 184
Check Instrument Level 514
Check Level 514
Check Point 186, 254
Close Traverse 284
Closing Figures 107
Code-Free Linework 89
Codes 80
COGO 308, 311
COGO History Viewer 283
COGO Results 283
CogoCalcs.txt 283
Command Console 569
Command Line 569
Comment 305
Common Buttons 40
Communication Link 555
Compass Balance 289
Complete Figure 108
Complex Figure 106

Configure Reference 543
Connect Points 116, 278
Connect Points Mode 116, 278
Connect/Disconnect 510
Contact Information 11
Contour Interval 432
Contours 440
Conventional Total Station 504
Convert Line-Spine 106
Coordinate Calculator 346
Coordinate Conversion 346
Coordinate Database 419
Coordinate System 143, 150, 416
Correction Information 563
Correction Link 555
Corrections 548, 555
CR5 Coordinate File 401
Cross Section 462
Cross Sections 407, 466, 472
Cursor Tracking 63
Curvature and Refraction 143
Curve Calculator 332
Cut Sheet Reports 412

D

Data Collector Models 23
Data Entry 42
Data Manager 418
Datum 143
DBF File 84
Default Height 528

Default Keyboard Shortcuts 151

Default Prism 520

Default Reflectorless 520

Default Settings 517, 523, 534

Delete Last Saved Point 280

Delete Point 280

Deleting Figures 110

Demo Mode 24

Descriptions 80

Direction Entry 49

Direction Format 142

Direction Unit 49

Disclaimer and Limited Warranty 2

Disconnect GPS 565

Display Settings 125

Display Toolbar 56

Distance Entry 45

Distance Offset 199

Distance Unit 45, 141

Disto 571

Disto/Laser Toolbar 66

DOP 65

Down/Out 316

Download 577

DP Record 280

Draw Figures Manually 116, 278

Draw Option Defaults 111

Drawing Tool 113, 276

DTM 429, 440, 473

DXF 91, 94, 402-403, 421

E

Edit Points 272

Edit Road 445

Edit Target 522, 532

EDM Mode 510, 517, 527-528

EDM Settings 500

Electronic Bubble 550

Elevation 150

Ellipsoid 346

Ellipsoid Height 143, 150

End-User License Agreement 2

End Figure 108

Equal Partitions 80

ESRI 84, 416

Exit 120

Export 395, 399-401, 403, 408, 411-412,
415-416

Export User Defined 416

Extended Edit Fields 42

F

FBK File 400

FEA File 84

Feature List Editor 84, 161

Fieldbook File 400

Figure Direction Marker 100

Figure List 102

Figures 89, 91, 95, 97, 100-102, 104, 106-
108, 110, 118, 408

Figures Draw Manually 116, 278

Figures Toolbar 92

File Types 41
Files 27, 122
Foresight 516, 526

G

Geodetic Coordinate 346
Geoid 143, 150, 346
Georeferenced Images 421
GIS 84
GNSS 537, 543-544
GNSS Demo 356
GNSS Local Transformation 249, 294-295,
299
GNSS Model and Communication 541
GNSS Offset Measure 243
GNSS Profile 356
GNSS Reference Profile 538
GNSS Rover 544
GNSS Rover Profile 539
GNSS Settings 560
GNSS Survey Report 401
GNSS Toolbar 64
GPS 64, 242, 248, 290, 547, 555, 558-559
 Correction Information 557
 Position Information 566
 Raw Data Logging 567
 Satellite List 559
 Sensor Information 565
Grid Shift File 150
Group Codes 252
GroupCode 154, 190, 193

GSM 555, 565
Guide Lights 510

H

Hardware Requirements 23
Hectares 334
Horizontal Angle Offset 201

I

Images 421
Import 392, 399, 402, 405, 408, 415, 421,
440
Import User Defined 416
Import/Export 390
Installation 24
Instrument Configuration 495
Instrument Selection 355
Instrument Settings 61, 63, 66
Instrument Settings Toolbar 510
Intersection 210, 212
Introduction 23
Inverse 308
Invert 209, 258

J

Job Information 161
Joystick Control 510
JPG/JPEG 421

K

Keyboard Shortcuts 151
Keypad 42-43
Kinematic 248

KML 416
Known Geodetic Position 236

L

Land Development Desktop 400
LandXML 405, 408, 421, 441, 443
LandXML Cross Sections 472
Language 153
Laser 571
Laser Plummet 514
Laser Pointer 510, 514
Laser Toggle 66
Layers Manager 421
Layout Elevation 375
LDD 400
Leica 529, 532
Leica Constant 527-528
Leica Geosystems 526, 531
Leica instruments 529
Leica Offset 527-528
Leica Target 526, 530
Leica targets 529
Level Bubble 510, 514
Level Bubble Sensitivity 514
Level Bubble Tolerance 514
License Agreement 2
Licensing 162
Line-Angle Intersection 212
Line-Distance Offset 205
Line-Perpendicular Point 213
Line Mode 113, 276

Line Toolbar 92
Lines 91, 95
Linework 89
Link Configure 562
Link Information 563
Local Transformation 290, 294-295, 299
Local Transformation to Point 236
Lock 62-63
Lots 408

M

Main Interface 54
Main Menu Button 120
Make and Model Settings 495
Manage Road 445
Manual Distance 234
Manual Entry 233
Manual Entry - Alignment C/L 446
Manual Entry - Template 462
Manual Entry - Vertical Profile 453
Map Data Layers Manager 421
Map Select Toolbar 70
Map View 54
Masks 543
Measure 61-63, 67
Measure Backsight 167
Measure Benchmark 182
Measure Distance 71
Measure Mode 61, 63, 65, 67
Measure Modes 164, 235, 241, 260
Measurement 242

Measurement Tolerance 501
MEP 381, 383, 388
Microsoft ActiveSync 577
Microsoft Windows Mobile Device
Center 577
MicroSurvey Software Inc. 11
MicroSurvey Transfer 581
Mini Toolbar Control 70
Model and Communication 496
Modem Settings 555
Mount Point 565
Multi-Set 193
Multi-Set Tolerance 501

N

Nautiz X7 88
New Figure 101
New Road 445
New Target 520-521, 530
No Communication 510
No Lock 62-63
No Store 187
Notes 86
NTRIP 555, 565

O

Observation Toolbar 58
Occupy 167
Offset 199, 201, 204-205, 213, 316
Offset Intersection 315
Offset Staking 483

Options 125
Default Units 131
GPS 132
Interface 126
Point Attributes 128
Point Labels 130
Roading 139
Staking 133
System 140
Total Station 132
User Input 127
Orthometric Height 150

P

Pad 113, 276
Pan 56
Parcels 408
Parcels (XML) 441
Partition Lines/Arcs 79
Patterns 302
PDOP 65
Perpendicular Offset 316
Photo Notes 88
Pipe Through Wall 387
Plan 113, 276
point 78
Point Averaging 75
Point by Arc Mode 116, 278
Point by Line Mode 115, 277
Point Chooser Toolbar 74
Point Labels 56, 130

Point Notes 86
Point on Wall 380
Point Patterns 302
Point Scanning 221-222, 228-229, 232
Point Staking Toolbar 363
Point Toolbar 72
Points 72
Points Database 419
Position Information 563
Predetermine Areas 334
Prism Constant 523, 527
Prism Offset 528
Prism Offsets 500
Prism Search Settings 502
Profile 537
Profiles 407, 443
Program Receiver 236
Program Settings 125
Project Files 41
Project Information 161
Project Manager 27, 122
Project Review 29
Projection 143, 416
Projects 27, 122

Q

QSB File 440
Quick Setup 264
Quick Start - Existing Project 30
Quick Start - New Project 33

R

Radio Configuration 498
Radio Settings 555
Radios 555
Raster Images 421
Raw Data Logging 565
Raw File Comment 305
Raw File Record Types 583
Raw File Viewer 280
RC-2 498
Re-activating Figures 108
Real-time DTM Surface 435
Reference 167, 543
Reference Position Modes 236
Reference Receiver 548
Reference Setup 548
Registration 24
Remote Height 204
Repair 24
Repeat Last Shot 233
Repitition 193
Resection 177
Resection Errors 179
Reset RTK Filters 565
Review Project Files 29
Road Alignment 372
Road Settings 445
Roading 443, 445-446, 453, 462, 466, 472-474, 483, 488
Roads 445, 466, 483, 488
Roads Manager 443

Robotic Total Station 506
Robotic Total Station Toolbar 62
Rotate 320, 325
Rotate / Translate / Scale 421
Rotate/Translate/Scale Points 320, 325
Rover 241, 544
Rover Receiver 549
Rover Setup 549
RPN Calculator 348
RTCM Transformation 556
RTK 242, 555
RTS 320, 325, 421
RW5 583

S

Satellite List 65
Satellite Plot 65, 558
Save 42
Save as Default Settings 143
Save Coordinate System 416
Save Template 412
Scale 320, 325
Scale Factor 142
Scientific Calculator 348
Scripts 569
SDR 399
Search 62-63
Search Settings 502
Sections 472
Select GNSS Profile 537
Select Line Toolbar 94

Select Point Toolbar 74
Send commands 569
Sensor Configure 561
Sensor Information 562
Set Angle 512
Set Default Height 516, 518, 526, 528
Sets 193
Settings 125
Settings Menu 124
Settings.xml 529
Setup 167
Sewer 443
Shapefile 415
Shift 320, 325
Shortcuts 151
Sideshot 188
Sideshot (Auto Store) 189
SIMA 399
SIP 43
Skymap 558
Slope Staking 488
Smart Tags 118
Sokkia 399
Splines 106
Split Lines/Arcs 79
Stake Alignment 372, 483
Stake Arc 368
Stake Elevation 375
Stake Line 368
Stake Offset 483
Stake Point 359

Stake Surface 373
Staking 199, 249, 363, 474, 483, 488
Staking List 376
Staking Menu 358
Staking Reports 412
Standard Deviation 179
Start Button 120
Starting 24
Station/Offset 316
StdDev 179
Store Point 71
Store Points 272
Supported Devices 23
Surface 440
Surface Manager 430
Surface Settings 432
Surface Volume 434
Surfaces 406, 429
Survey Tools 271
Switching Active Figures 102
SyncWizard 582
Syntax 569

T

Target 528
Target Height 61, 516, 526, 528
Target List 516-517, 519, 521, 526, 529-530
Target Manager 61, 63, 66, 516, 521, 526,
530
Target Name 531
TDS 583

Technical Support 9
Template 408, 411, 462
Templates 466, 472
Temporary (No Store) 187
temporary height 523
Temporary Height 518, 528
Text Notes 87
TGRID 435
TIF/TIFF 421
Tilt Offset 246
Tilt Survey 550
TIN 435
Tolerance Modes 544
Tolerances 543
Topo Toolbar 67
Total Station 504, 506
Total Station Configuration 495
Total Station Demo 356
Total Station Make and Model 495
Total Station Profile 356
Total Station Toolbar 61
Transform 421
Transformation 150, 290, 294-295, 299
Translate 320, 325
Transmit Corrections 548
Traverse 188
Traverse / Intersection 311
Traverse Adjustment 289
Traverse Report 284
Triangle Calculator 344
Trilateration 216, 256

Turn 513
Turn Instrument 510
Turn to Point 71
Two Line Intersection 210

U

Unit Settings 140
Units 45, 49
Upload 577
User Defined 531
User Defined Coordinate Systems 416
Using Active Figures 97

V

Version 162
Vertical Angle Offset 204
Vertical Balance 289
vertical offset 382, 386, 388
Vertical Plane Projection 218
Vertical Profile 453
Volume 433

W

Wall 388
Windows Mobile Device Center 577

X

XML 405, 408, 421, 441, 443, 472

Z

Zoom 56